

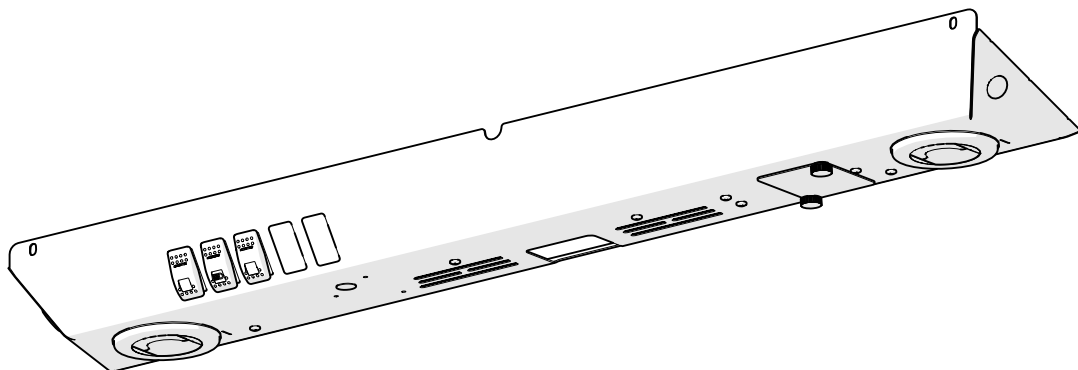

**CLUB CAR CARRYALL
1500 / 1700
OVERHEAD CONSOLE
p/n: 47617522001**



Approximate Installation Time *
Experienced Dealer Technician – 15 Minutes
Average Dealer Technician – 20 Minutes
Do-It-Yourself – 30 Minutes

(* = Not including accessories)

Approximate Product Specifications

The contents of this envelope are the property of the owner. Leave with the owner when installation is complete.

WARNINGS, TIPS, & REQUIRED TOOLS

For accurate installation, proper operation, and years of satisfaction, please read and understand the installation and owner's manual fully prior to installing the console.

From all of us at Curtis, we thank you for choosing our product.



NOTICE

Curtis Cabs, blades and general accessories add additional weight to the base vehicle. All Curtis accessory weights are listed in product brochures. Deduct the accessory's total weight from the vehicle's rated capacity and never exceed the vehicle's rated capacity including driver and passenger.



WARNING *Exposure to Carbon Monoxide can Cause illness, serious injury or death.* Never operate vehicle if suspicious of Carbon Monoxide. Inspect exhaust system for leaks monthly. Leaks can result from loose connections, corrosion, cracks or other damage to the exhaust manifold. If leaks are found, repair or replace exhaust system. Do not use vehicle until repair or

TOOLS REQUIRED:

- 3/8" wrench or socket.
- Wire cutters.
- Electrical tape.

INSTALLATION

1. Console and Cab Preparation:

NOTE: Skip any of the following steps if not installing that accessory at this time. Follow the instructions included with the accessory.

- 1.1 Install the Dome Light to the console panel and attach the orange/black wire inside the console to the dome light.
- 1.2 Install the Heater wire harness, switch, and fuse into the console and route the harness through the hole in the right side of the console panel.
- 1.3 Install the Windshield Washer harness, switch, and fuse into the console. Route the harness to the left of the console and attach it to the main console harness with a cable tie.
- 1.4 Install Work Lights and Strobe Light to the cab.
- 1.5 Install the interior mirror bracket to the windshield support, but leave the mirror itself off. If a mirror is already installed, remove the mirror from the mounting bracket.
- 1.6 Underneath the driver's seat (1500) or rear seat (1700), remove the 7.5 amp fuse from the cab wire harness and replace it with a 25 amp fuse included with the console kit. See figure 1.6.
- 1.7 Install a 1/4-20 clip nut (4 total) into the slots and holes at the corner of each flange of the windshield support, with the flat side of the nut on the outside. See figure 1.7.

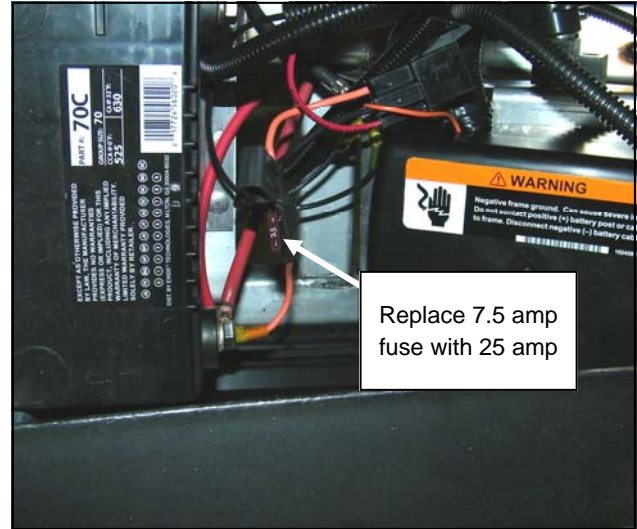

Fig. 1.6

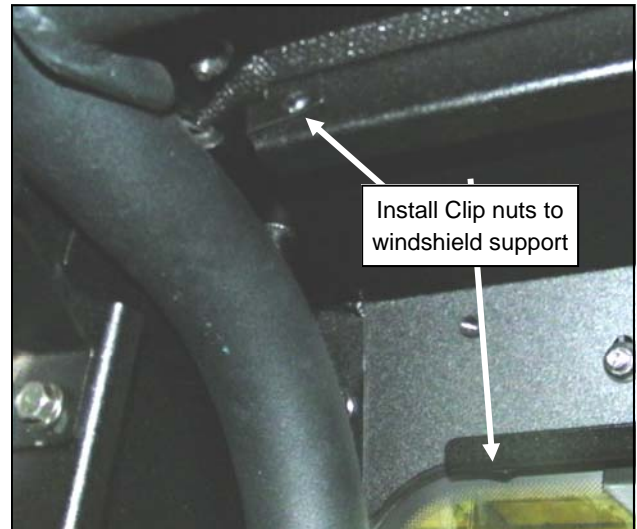

Fig. 1.7

INSTALLATION

2. Console Installation:

- 2.1 Install the end of each Tether from the Console into the Windshield Support and allow the Console to hang. See figure 2.1.
- 2.2 Cut the cable tie from the coiled yellow/black wires inside the console. Be careful not to cut any wires. Feed the yellow/black wires through the hole in the top/center of the windshield support and connect to the Strobe Light wires. See figure 2.2.
- 2.3 Wrap a 6" long section of 1/2" wire loom (included with the strobe light) around the strobe light connectors and secure with electrical tape. Secure the wires to the top/center ROPS tube with cable ties.
- 2.4 Connect the blue/black wires to the Work Light wires at both sides of the console
- 2.5 Place the console up against the windshield support and loosely thread a 1/4-20 x 5/8" bolt into the clip nuts at each corner. Verify that no wires or tethers are visible or pinched between the console and windshield support.
- 2.6 Beside the dashboard on the driver's side, connect the console wire harness in line between the wiper wire harness and the cab harness. See figure 2.6.
- 2.7 Turn the ignition switch on. Verify the function of each switch and accessory, then turn the ignition off.
- 2.8 Torque the 1/4-20 bolts for the console to 120±5 inch-pounds. Secure the Console harness and Windshield Washer harness (if applicable) to the cab on the left, and Heater harness (if applicable) on the right using cable ties through the slots in the A-pillar. Tuck wires beside and under the dashboard.

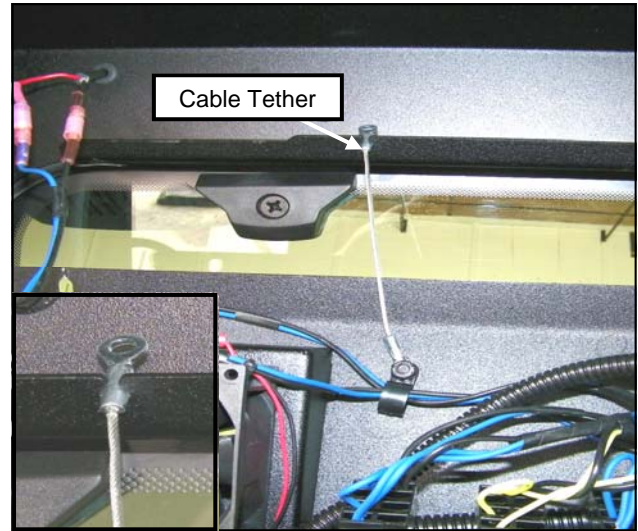

Fig. 2.1

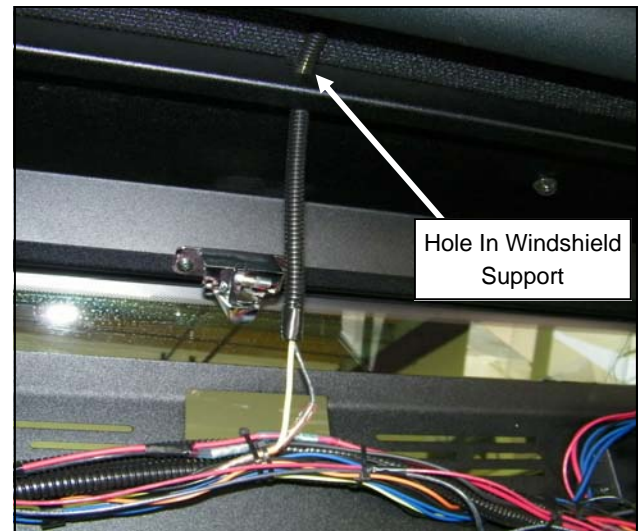

Fig. 2.2

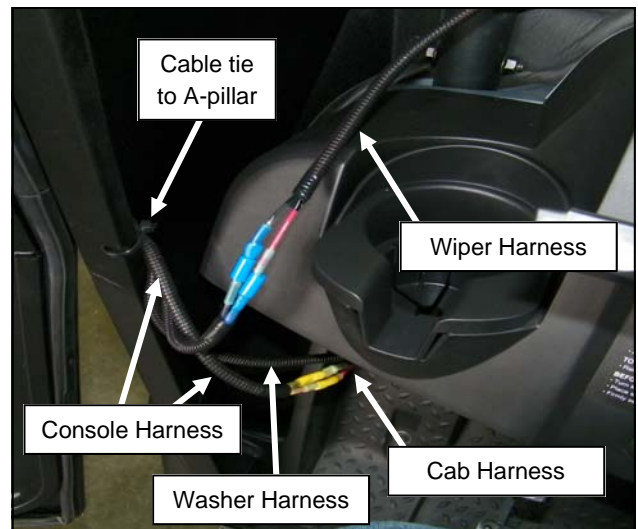
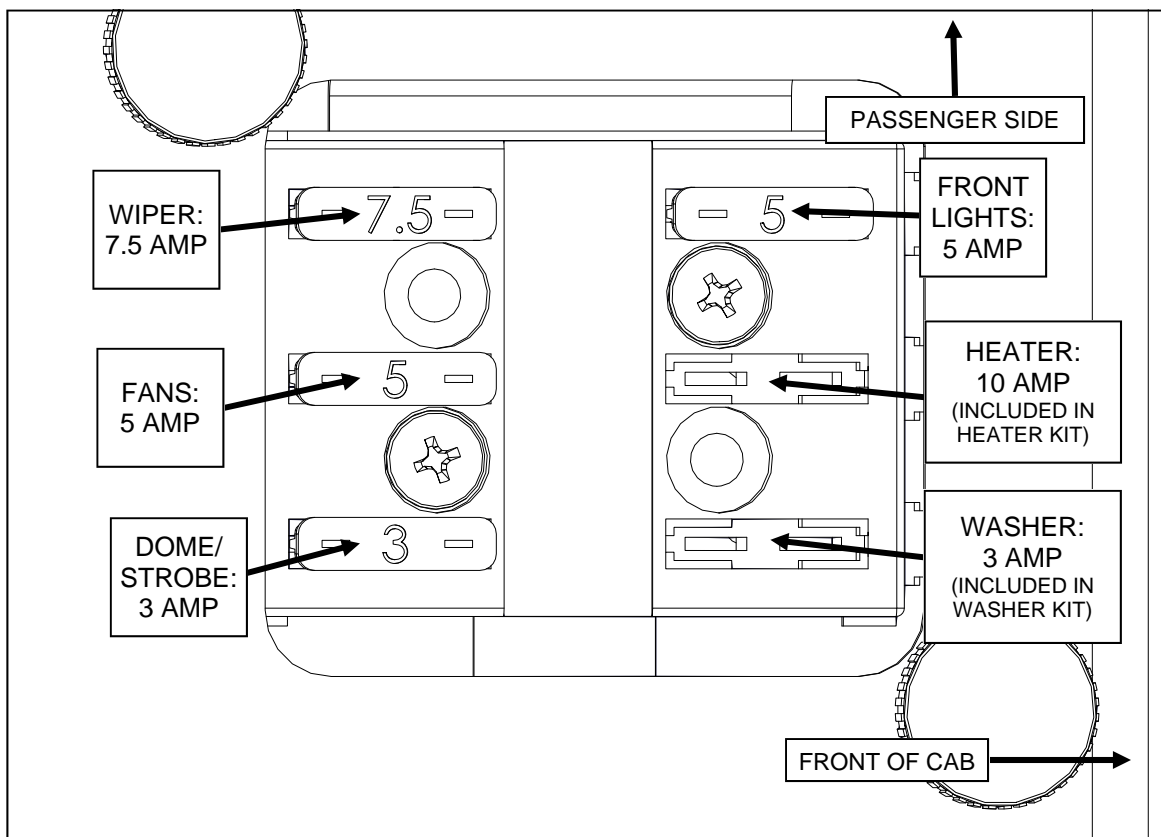

Fig. 2.6

OVERHEAD CONSOLE TROUBLESHOOTING

Condition	Possible Solution
<ul style="list-style-type: none"> All console lights are off 	<ul style="list-style-type: none"> Vehicle Ignition Key is off Check 25 Amp fuse
<ul style="list-style-type: none"> One switch light is off 	<ul style="list-style-type: none"> Check fuse for that device (see below) Switch is not connected to fuse block
<ul style="list-style-type: none"> Switch light is on, device does not function 	<ul style="list-style-type: none"> Device is not connected to console Connection polarity is reversed Check device to 12V power source
<ul style="list-style-type: none"> Console will not turn off 	<ul style="list-style-type: none"> Check cab wiring Check relay in cab harness



SERVICE PARTS

#	PART NUMBER.	DESCRIPTION	QTY.
1	8SV-FP01-B4	FUSE BLOCK, 6-POSITION WITH MOUNTING BRACKET	1
2	8SV-OHCFC-B4	FUSE COVER	1
3	9SV-OHC1	AXIAL FAN, 80mm X 80mm	1
4	9SV-LVR02	LOUVER VENT, 4" LOW-PROFILE	1
5	9SV-WH-00052	WIRE HARNESS, CONSOLE	1
6	9SV-WH-00030	WIRE HARNESS, BEACON LIGHT AND DOME LIGHT	1
7	9SV-WH-00031	WIRE HARNESS, WORK LIGHTS	1
8	9SV-OHCSCC	SWITCH SET, (SET OF 3 SWITCHES WITH COVERS)	1

