

**Club Car Carryall  
Driving Range Enclosure  
Part Number 1CCCABC  
Compatible with Carryall models 300, 500, 550 and 700**

The contents of this manual are the property of the owner.  
Be sure to leave with the owner when installation is complete.



**APPROXIMATE INSTALLATION TIME:** 3 hours for full cab (not including accessories)

**BEFORE YOU START:**

- Read and understand all instructions before beginning.
- To assist with the cab installation, leave all bolts loose for later adjustment unless otherwise specified.
- Use caution to avoid damaging the factory installed threaded inserts. Begin the bolt engagement by hand to guard against potential cross threading.

**Tools Required:**

- T40 Torx driver
  - Ratchet with 3/8", 7/16", 1/2" and 9/16" sockets
  - (Optional) Air or electric powered socket driver
- NOTE: Powered driver is not recommended for bolts into threaded inserts in the roof and rear frame.
- 3/8", 7/16" and 1/2" and 9/16" open-end wrenches
  - 5/32", 3/16" and 7/32" Allen wrenches or drivers.
  - Power hand drill and 5/16" drill bit.

**SAFETY INFORMATION:**

**⚠ WARNING:** Cabs and general accessories add additional weight to the base vehicle. Deduct the accessory's total weight from the vehicle's rated capacity including driver and passenger. Never operate the vehicle outside of its rated weight capacity.

- Total weight of Range Enclosure assembly is approximately 200lbs (90.7kg).

**⚠ WARNING: Exposure to Carbon Monoxide can cause illness, serious injury or death.**

Never operate vehicle if suspicious of Carbon Monoxide. Inspect exhaust system for leaks monthly. Leaks can result from loose connections, corrosion, cracks or other damage to the exhaust manifold. If leaks are found, repair or replace exhaust system. Do not use vehicle until repair or replacement is complete.

**A Tailpipe extension is supplied with every cab and must be installed onto gasoline vehicles to avoid illness, serious injury or death from Carbon Monoxide.**

**⚠ WARNING: Serious injury or death:**

- This cab enclosure does not provide protection from rollover or other accidents.
- This cab enclosure does not provide protection from lightning or other storm-related hazards. When lightning threatens, take cover and do not operate vehicle.

**PARTS INCLUDED IN THIS KIT:**

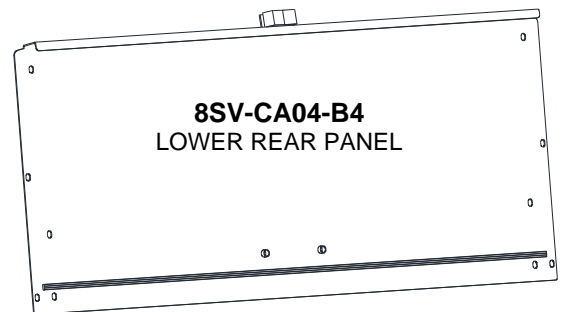
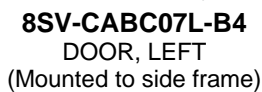
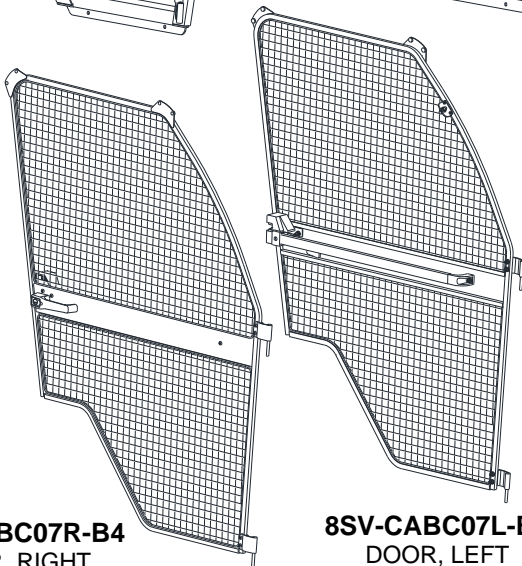
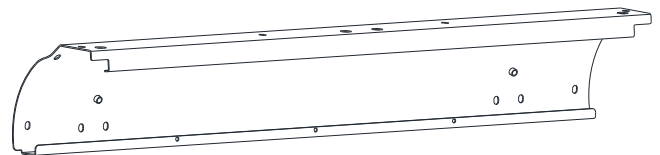
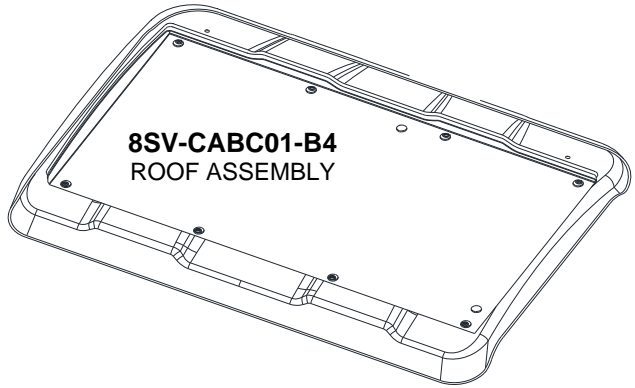
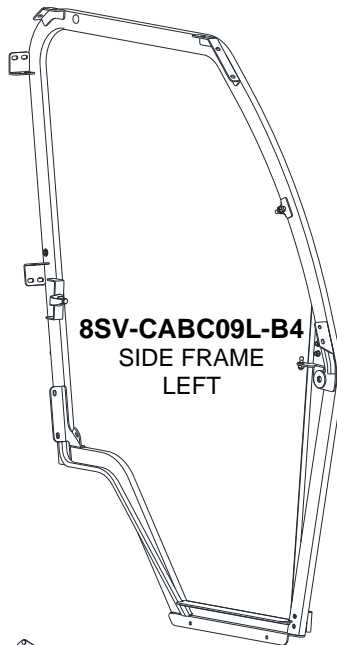
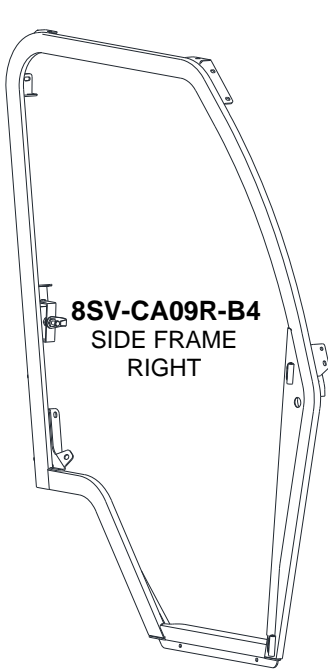

**CONTINUED ON PAGE 3**

**PARTS IN THIS KIT (Continued):**

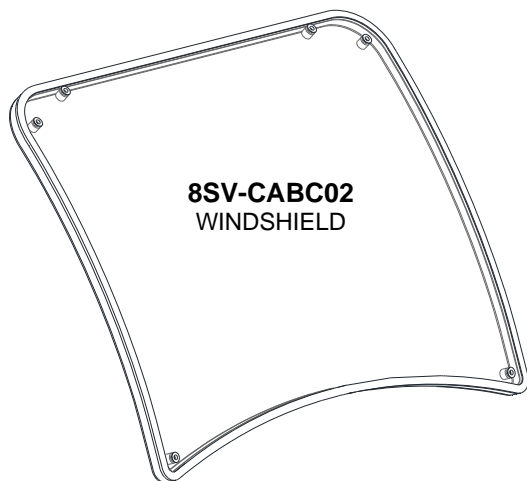

**8SV-CABC02**  
WINDSHIELD

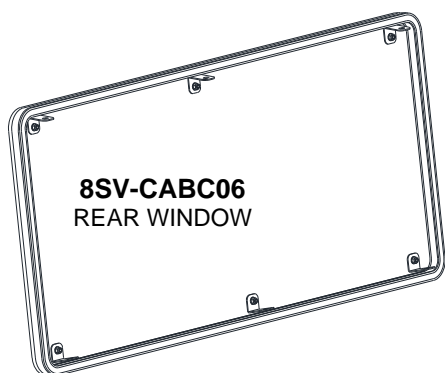

**8SV-CABC06**  
REAR WINDOW

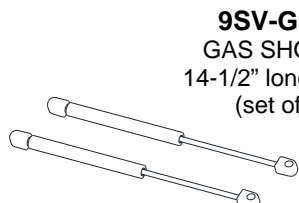

**9SV-GS05**  
GAS SHOCKS  
14-1/2" long, 100N  
(set of 2)

1/2" x 9/16" Foam Rubber  
2 PCS, 31" Long  
**9SV-PR43-4** (4-Foot Length)

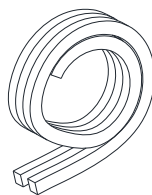

1" Dome Plugs  
(QTY:2)



1/2" V-Groove Weather Seal  
2 PCS, 50" Long  
**9SV-PR20-10** (10-Foot Length)

QTY: (2) 3/8-16 x 1-1/4" Button Head Bolt		QTY: (6) 5/16-18 x 1" Flanged Hex Bolt	
QTY: (4) 1/4-20x 2-1/4" Flanged Hex Bolt		<b>CA-HWK-A</b>	
QTY: (8) 1/4" x 1"OD Fender Washer			
QTY: (2) 3/8" SAE Flat Washer		QTY: (24) 5/16-18 x 3/4" Flanged Hex Bolt	
QTY: (18) 5/16-18 Flanged Lock Nut		QTY: (4) 1/4-20 Flanged Lock Nut	
<b>CA-HWK</b> CARRYALL HARDWARE KIT			

QTY: (6) 1/4-20x 1-1/2" Flanged Hex Bolt		QTY: (2) 5/16-18 x 3/4" Flanged Hex Bolt	
QTY: (6) 1/4-20 Flanged Lock Nut		<b>CABC-HWK</b> CARRYALL RANGE CAB HARDWARE KIT	
QTY: (6) 1/4" x 1"OD Fender Washer			
QTY: (2) 5/16-18 Flanged Lock Nut			

**ADDITIONAL SERVICE PARTS:**

- **9SV-RG**.....Rubber Window Grommets, set of 12
- **9SV-HSLP**.....Hinge Set with 1 each left and right hinge pins and 2 sleeves
- **9SV-OHRL**.....Outer Door Handle, set of 2
- **9SV-DL02**.....Door Latch kit, non-locking w/ grab handle (set of left/right)
- **8SV-SM-00105**...Door Latch Mounts (set of left/right)
- **8SV-CABC12-B4**...Rear Window Tab, set of 6
- **9SV-GS02A**.....Ball Studs, 10mm (bag of 10)
- **9SV-DSTRH**.....Door Striker hardware
- **9SV-PRO2-15**...Standard Bulb Rubber, (5/8"), 15-Foot Length
- **9SV-PR38-15**...3/4" Side Bulb Rubber 1/4" grip, 15-Foot Length
- **8SV-CA01P**.....Plastic Roof Panel
- **8SV-CA01M-B4**...Metal Roof Panel
- **8SV-SM00182**...Gas Spring Mount, Bolt On



**9DL-158**  
Tilt Bed Warning Decal



**9DL-186**  
Gas/Fire Warning Decal



### 1. CARRYALL PREPARATION:

- 1.1 Remove and discard the bolts holding the seat back to the side bolsters (**Figure 1.1**).
- 1.2 Remove and discard the plastic caps, bolts and washers at either side of the dashboard (**Figure 1.2**).
- 1.3 Apply one thick foam strip along the front of the foot well and beside the dashboard (**Figure 1.3**). Start at the bottom corner and work up. Trim any excess at the upper corner flush to the dashboard.

NOTE: Be sure the area is clean, dry, and at room temperature before adhering the foam.

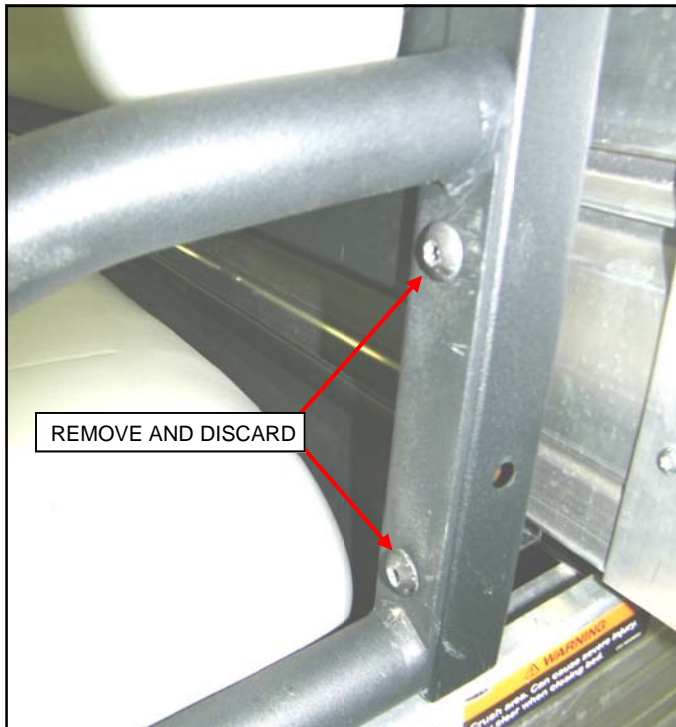

Figure 1.1: Seat Side Bolts

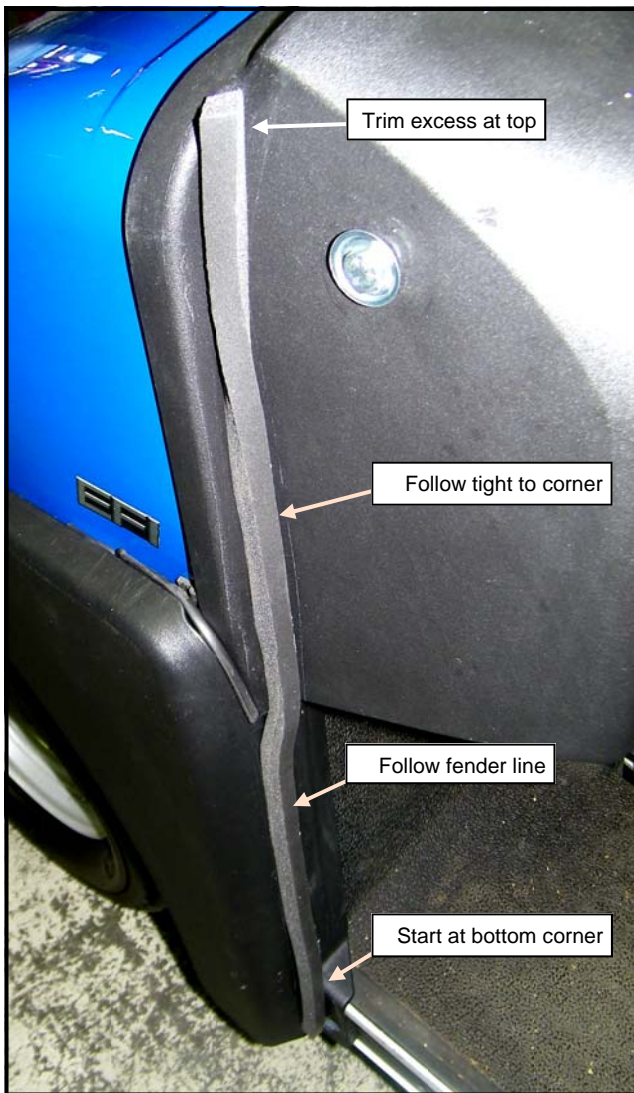

Figure 1.3: Dashboard Side Rubber



Figure 1.2: Dashboard Side Bolts

## 2. CAB STRUCTURE:

NOTE: This cab includes doors mounted onto side frames for shipment. Remove the doors from the frames prior to assembly by unlatching the door and lifting it off the frame pins.

2.1 Apply the 1/2" V-groove weather seal rubber to the rear of the cab frames (**Figure 2.1**). Peel the paper from one end and press the rubber onto the frame, starting at the bottom corner. Continue to peel and press the rubber over the upper corner of the frame. Route the rubber onto the upper tab, beside the outer edge of the slots as shown. Trim any excess at the front of the upper tab.

NOTE: This weather strip rubber must be installed onto the frame prior to installing the lower and upper rear panel, to ensure a tight seal and dampen vibration.

### 2.2 QTY Hardware Required:

- (2) 3/8-16 x 1-1/4" Button Socket Head Bolts
- (2) 3/8" SAE Flat Washers

Place each side frame onto the Carryall, resting on the floorboard and against the side bolsters (**Figures 2.2 and 2.3**). Push the frame forward against the dashboard and install a button head bolt with washer through the hole in the frame into the captive nuts at the sides of the dashboard (**Figure 2.2**).

### 2.3 QTY Hardware Required:

- (4) 1/4-20 x 2-1/4 Flanged Hex Bolts
- (4) 1/4" x 1" Fender Washers

Per **Figure 2.3**, insert a 1/4" bolt with one fender washer through each of the two holes in the bracket at the rear of each side frame, through the seat back. Do not install nuts at this time.

NOTE: Leave all fasteners loose or finger-tight until the entire cab frame structure and roof is assembled at step 6, unless otherwise specified.



Fig. 2.2: Frame to Dash bolts

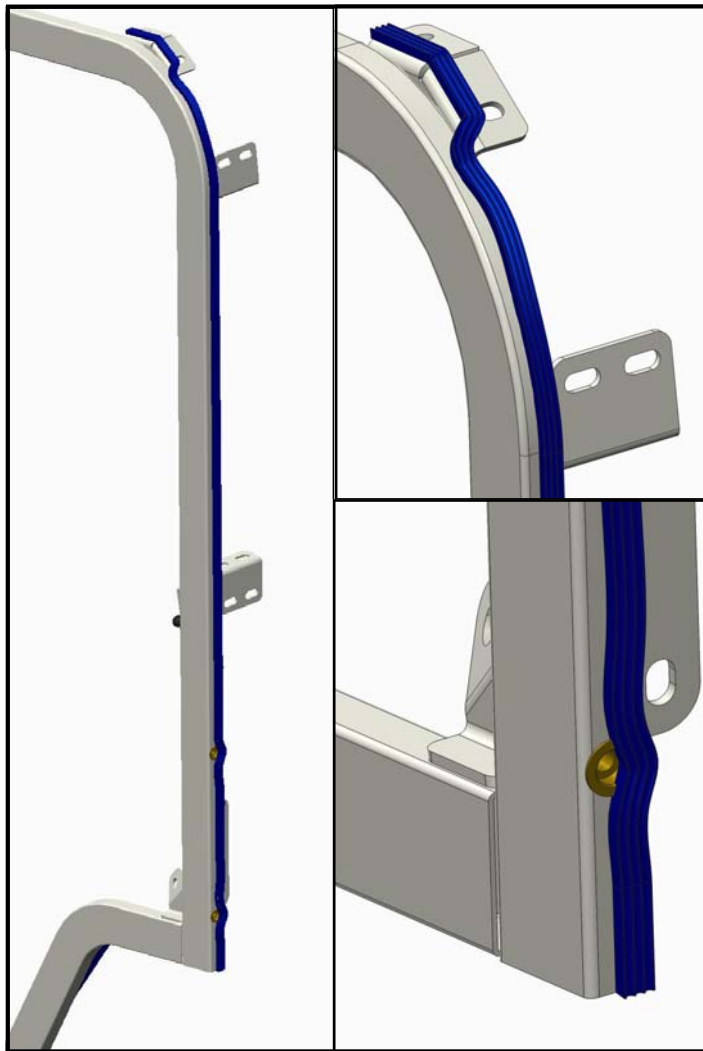

Figure 2.1: Frame Rear Rubber

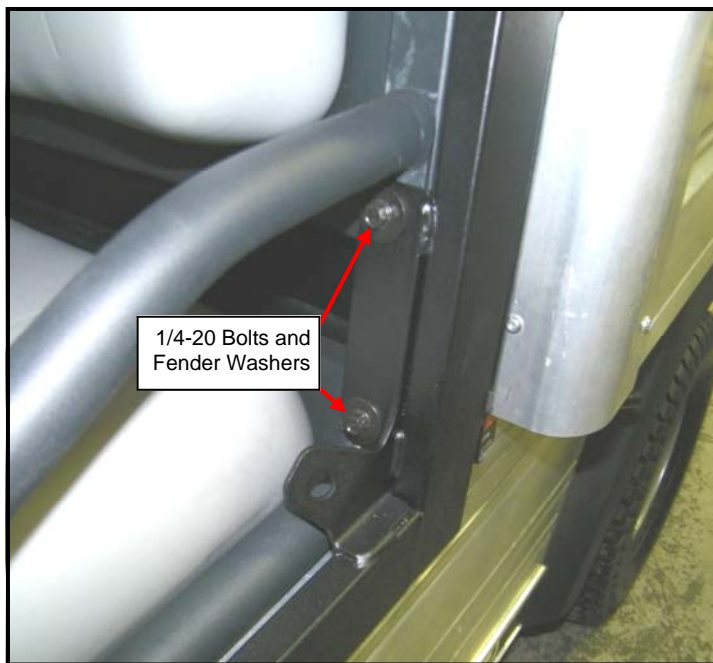

Fig. 2.3: Frame and Seat bolts

## 2. CAB STRUCTURE (Continued):

### 2.4 LOWER REAR PANEL:

QTY Hardware Required:

- (6) 5/16-18 x 3/4" Flanged Hex Head Bolts
- (2) 5/16-18 Flanged Hex Lock Nuts

Place the Lower Rear Panel onto the frame tabs above the seat, and over the 1/4" bolts installed in step 2.2 (**Figure 2.4**). Install a 5/16" bolt into the two threaded inserts in the rear of each frame, and one 5/16" bolt and nut in the rear face in each upper corner of the rear panel.

NOTE: The holes in the upper flange of the lower rear panel will be used to install the rear window.

NOTE: Use of a power driver into the threaded inserts of the frame is not recommended, to help avoid cross-threading the inserts.

### 2.5 QTY Hardware Required:

- (4) 1/4" x 1" Fender Washers
- (4) 1/4-20 Flanged Hex Lock Nuts

Install a fender washer and 1/4" nut onto the four bolts through the frame and seat from step 2.2. (see Figure 2.4)

### 2.6 UPPER REAR PANEL:

QTY Hardware Required:

- (4) 5/16-18 x 1" Flanged Hex Head Bolts
- (4) 5/16-18 Flanged Hex Lock Nuts

Install the Upper Rear Panel onto the frame by hooking the lower flange under the lower frame tabs and rotating the panel forward (**Figure 2.6**). Install four 5/16" x 1" bolts and nuts through the four holes in the rear face of the panel.

Push the bottom flange of the panel up against the frame tabs and tighten the two lower bolts, then the upper bolts, to remove the gap between the panel and frame. Do not fully torque the bolts at this time.

NOTE: The holes in the lower flange of the upper rear panel will be used to install the rear window.

NOTE: Do not install bolts through the holes in the top of the Upper Rear Panel or Windshield Support. These holes will be utilized to install the roof.

### 2.7 WINDSHIELD SUPPORT:

QTY Hardware Required:

- (4) 5/16-18 x 3/4" Flanged Hex Head Bolts
- (4) 5/16-18 Flanged Hex Lock Nuts

Place the Windshield Support onto the front tabs of the frame, and install 5/16" bolts and nuts through the four front holes of the windshield support (**Figure 2.7**).

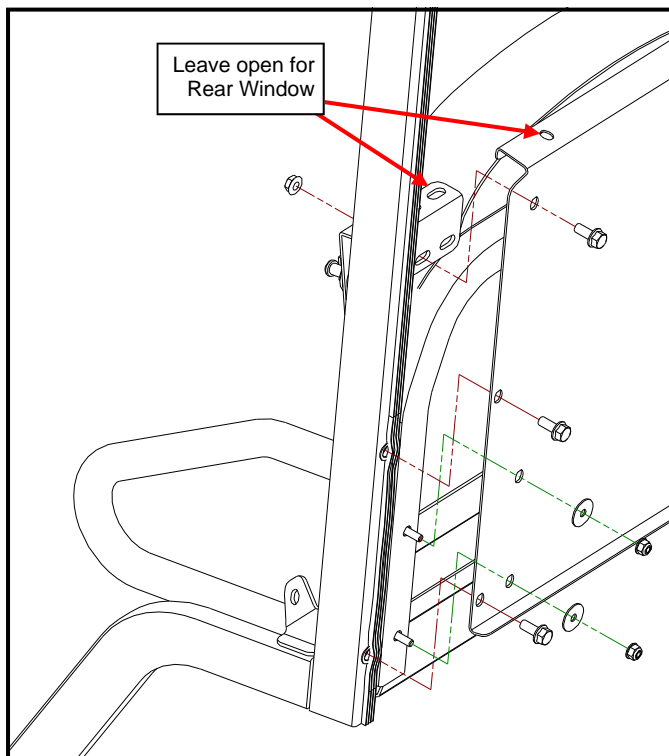

Figure 2.4: Lower Rear Panel

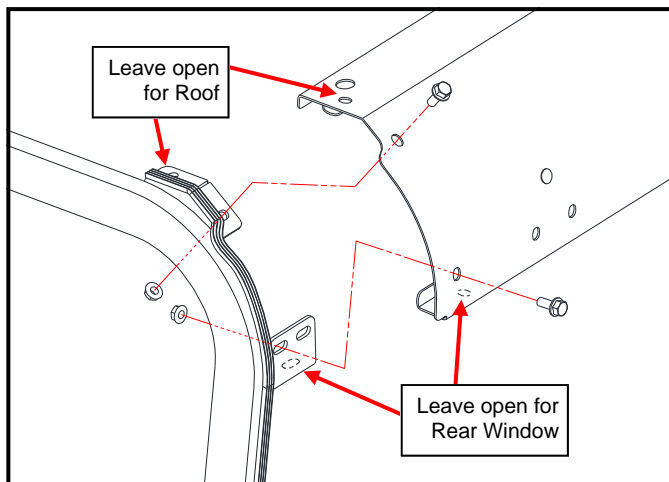

Figure 2.6: Upper Rear Panel

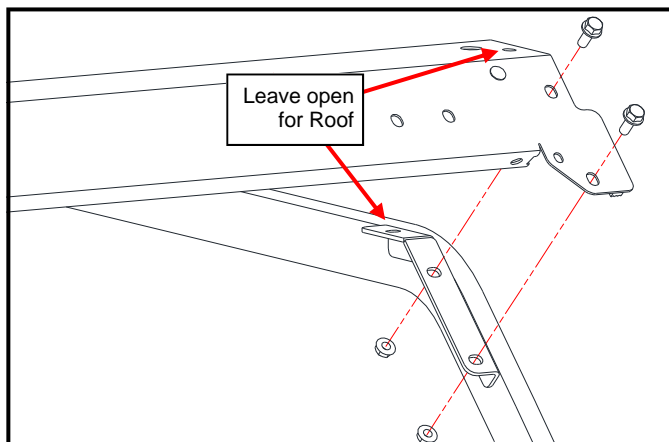

Figure 2.7: Windshield Support



**3. ROOF:**

**3.1 QTY Hardware Required:**

(8) 5/16-18 x 3/4" Flanged Hex Head Bolts  
 With assistance, place the roof assembly on top of the frame (**Figure 3.1**). Align the threaded inserts in the roof with the holes in the windshield support and upper rear panel and install four 5/16-18 x 3/4" bolts through each panel and into the inserts in the roof.

**NOTE:** Use of a power driver into the threaded inserts of the roof is not recommended, to help avoid cross-threading the inserts.

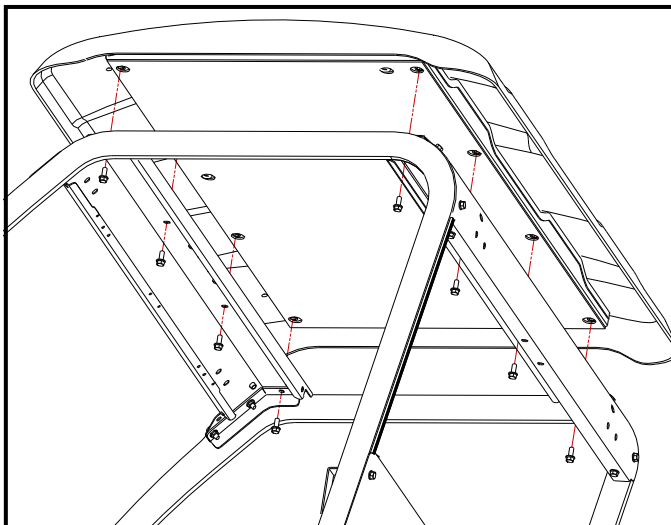

**Figure 3.1: Roof Installation**

**4. WINDSHIELD:**

**4.1** Tighten the four bolts for the Windshield Support into the frames to 17 lb-ft (23.0 N-m). Tighten the two 3/8" bolts installed in step 2.2.

**4.2 QTY Hardware Required:**

(6) 1/4-20 x 1-1/2" Flanged Hex Bolts  
 (6) 1/4" x 1" Fender Washers  
 Install a 1/4" bolt with fender washers into the six rubber grommets of the Windshield (**Figure 4.2**).

**4.3 QTY Hardware Required:**

(6) 1/4-20 Flanged Hex Lock Nuts  
 With assistance, place the windshield onto the front of the cab with the 1/4" bolts through the holes in the Windshield Support (**Figure 4.2**). Install a 1/4" nut onto the two bolts the top of the windshield, then the next pair of bolts, working down and bending the windshield to contact the frames. Tighten the nuts just until there is no space under all six nuts.

**4.4** Center the Windshield on the side frames and tighten from bottom to top until the Windshield rubber is compressed with no visible gaps.

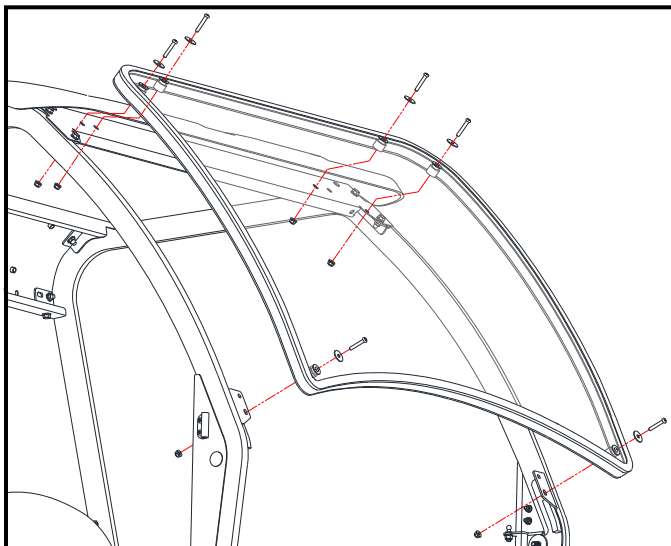

**Figure 4.2: Windshield Installation**

**5. REAR WINDOW:**

**5.1 QTY Hardware Required:**

(2) 5/16-18 x 1" Flanged Hex Head Bolts  
 (4) 5/16-18 x 3/4" Flanged Hex Head Bolts  
 (6) 5/16-18 Flanged Hex Lock Nuts

With assistance, hold the Rear Window against the rear of the cab and secure it to the inside flanges of the upper and lower rear panel (**Figure 5.1**). Use the 1" long bolts in the outer corners of the upper panel.

**NOTE:** If necessary, loosen the bolts for the brackets to the rear window to get the brackets to fit tight against the upper and lower rear panels.

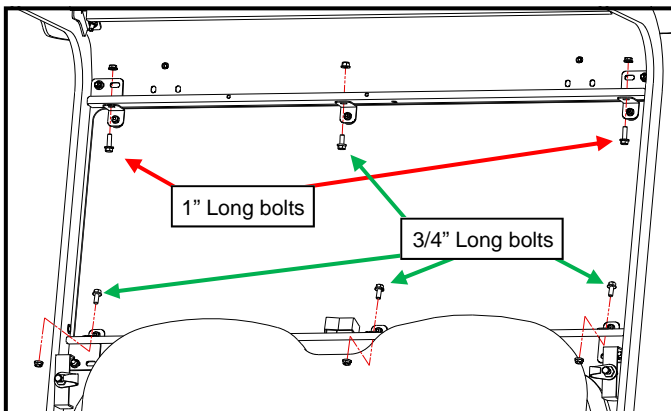

**Figure 5.1: Rear Window Installation**

**6. FASTENER TIGHTENING:**

- 6.1 Check alignment of the cab parts to be as square as possible, and tighten all 5/16" bolts to 17 lb-ft (23.0 N-m) in the following order:
  - 4 bolts into roof at Windshield Support.
  - 4 bolts into roof at Upper Rear Panel.
  - 6 bolts through Upper Rear Panel and frame.
  - 8 bolts through Lower Rear Panel and frame.
- 6.2 Tighten the four 1/4" bolts through the Carryall seat and Rear panel to 7 lb-ft (9.5 N-m).
- 6.3 Tighten the 3/8" bolts in the front of the frame to 24 lb-ft (32.5 N-m) and insert a 1" plug into the holes in the panel at the front of the frame.
- 6.4 QTY Hardware Required:
  - (4) 5/16-18 x 3/4" Flanged Hex Head Bolts
  - (4) 5/16-18 Flanged Hex Lock Nuts

Drill a 5/16" hole through the two holes in the lower flange of each floorboard (**Figure 6.4**), through the structure of the Carryall, and install a 5/16" bolt and nut through these holes. Tighten to 17 ft-lb (23.0 N-m).



**Figure 6.4:** Floorboard bolts

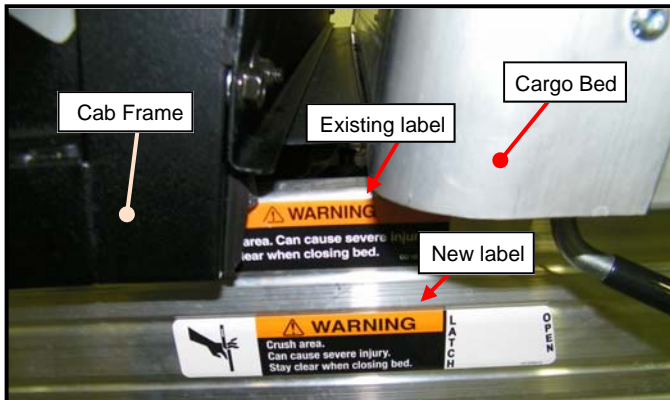

**Figure 7.1:** Tilt Bed Warning Label

**7. WARNING LABELS:**

- 7.1 Apply the Tilt Bed Warning Label on the driver's side of the Carryall, near the front of the Cargo Bed and below the cab frame as shown (**Figure 7.1**).
- 7.2 Gasoline Vehicles only: Apply the Gas/Fire Warning Label forward of the Fuel Cap as shown (**Figure 7.2**).

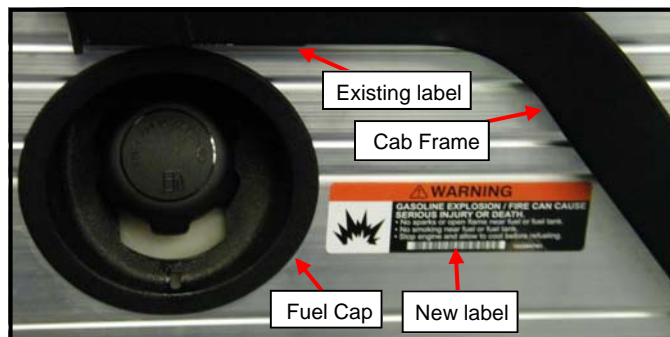

**Figure 7.2:** Gas/Fire Warning Label

**8. DOORS:**

- 8.1 Holding the door perpendicular to the vehicle, lower the door hinge pins into the hinge sleeves on the frame. (**Figure 8.1**).
- NOTE: Loosen the bolts on the hinges on the door and/or the frame, if the pins do not slide easily and fully into the sleeves.
- 8.2 Gently close the door, lifting on the door handle if necessary, to allow the latch to lock around the striker pin. Ensure that you have heard (2) clicks of the latch. Use a long straight edge to ensure that the hinges are in-line with each other.
  - 8.3 With an assistant sitting inside the vehicle, tighten the (4) 1/4-20 hinge screws and nuts, if loosened in step 2 on page 5.
  - 8.4 Open the door to slightly less than 90°. Install the Gas Shock onto the Ball Studs of the frame and door (**Figure 8.4**). The cylinder end must be attached to the door as shown to ensure seals stay lubricated.

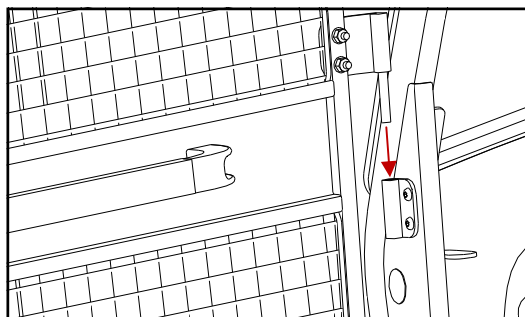

**Figure 8.1:** Door hinge pins into frame sleeves

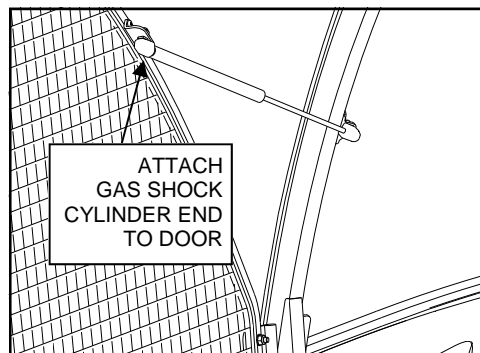

**Figure 8.4:** Door gas shock



## DOOR TROUBLESHOOTING

Condition	Possible Solution
<ul style="list-style-type: none"> <li>• Door latch and striker pin don't line up vertically</li> </ul>	<ul style="list-style-type: none"> <li>• Loosen striker pin and move up or down.</li> <li>• Use (2) 3/4" wrenches to adjust striker pin.</li> </ul>
<ul style="list-style-type: none"> <li>• Door latch and striker pin don't line up horizontally</li> </ul>	<ul style="list-style-type: none"> <li>• Remove plastic covers on interior door latch. Loosen (2) 1/4-20 button head screws on the latch mount and (1) 1/4-20 pan head screw at the front of the handle.</li> <li>• Move interior door latch forward or backward.</li> </ul>
<ul style="list-style-type: none"> <li>• Door is not aligned to vehicle</li> </ul>	<ul style="list-style-type: none"> <li>• Loosen door hinges.</li> <li>• With the door unlatched, lift up (or lower down) on the door handle until the door is aligned with the vehicle.</li> <li>• Have an assistant sit inside the vehicle and determine the new height required for the striker pin.</li> <li>• Have the assistant adjust the height of the striker pin.</li> <li>• Re-latch the door and tighten all fasteners.</li> </ul>

## CARE AND MAINTENANCE

Check and tighten all hardware after 20 hours of operation. Periodically inspect and tighten hardware for the remainder of the unit's service life. Keep the enclosure components clean in order to prevent dust and dirt from forming an unattractive film. The life of your cab components depend upon following these care procedures:

1. **NEVER USE** AN ABRASIVE DETERGENT / VEHICLE CLEANER OR A WIRE BRISTLED BRUSH. Do not use any **CITRUS BASED CLEANERS** such as orange or lemon.
2. **NEVER USE** AN ALCOHOL-BASED PRODUCT FOR CLEANING PLASTIC WINDOWS. Do not use **WINDEX, GLASS PLUS, FANTASTIC**, etc. Use of these products will result in deterioration of the plastic windows.
3. Clean the enclosure surfaces thoroughly with warm soapy water and a COTTON cloth or chamois. Be sure to use mild soap, specifically a dish liquid or equivalent. Clean in a light circular motion for best results.
4. Use EXTRA CAUTION when cleaning the interior of the enclosure. The interior is more sensitive than the exterior.
5. Remove grease and oil with mineral spirits and a COTTON cloth or chamois.