



John Deere Gator TS Canopy
p/n: 1CT2A

An optional windshield may be purchased for use with the canopy (P/N: 1WS1A)

The contents of this envelope are the property of the owner.
Be sure to leave with the owner when installation is complete.

APPROXIMATE INSTALLATION TIME: 1 HOUR

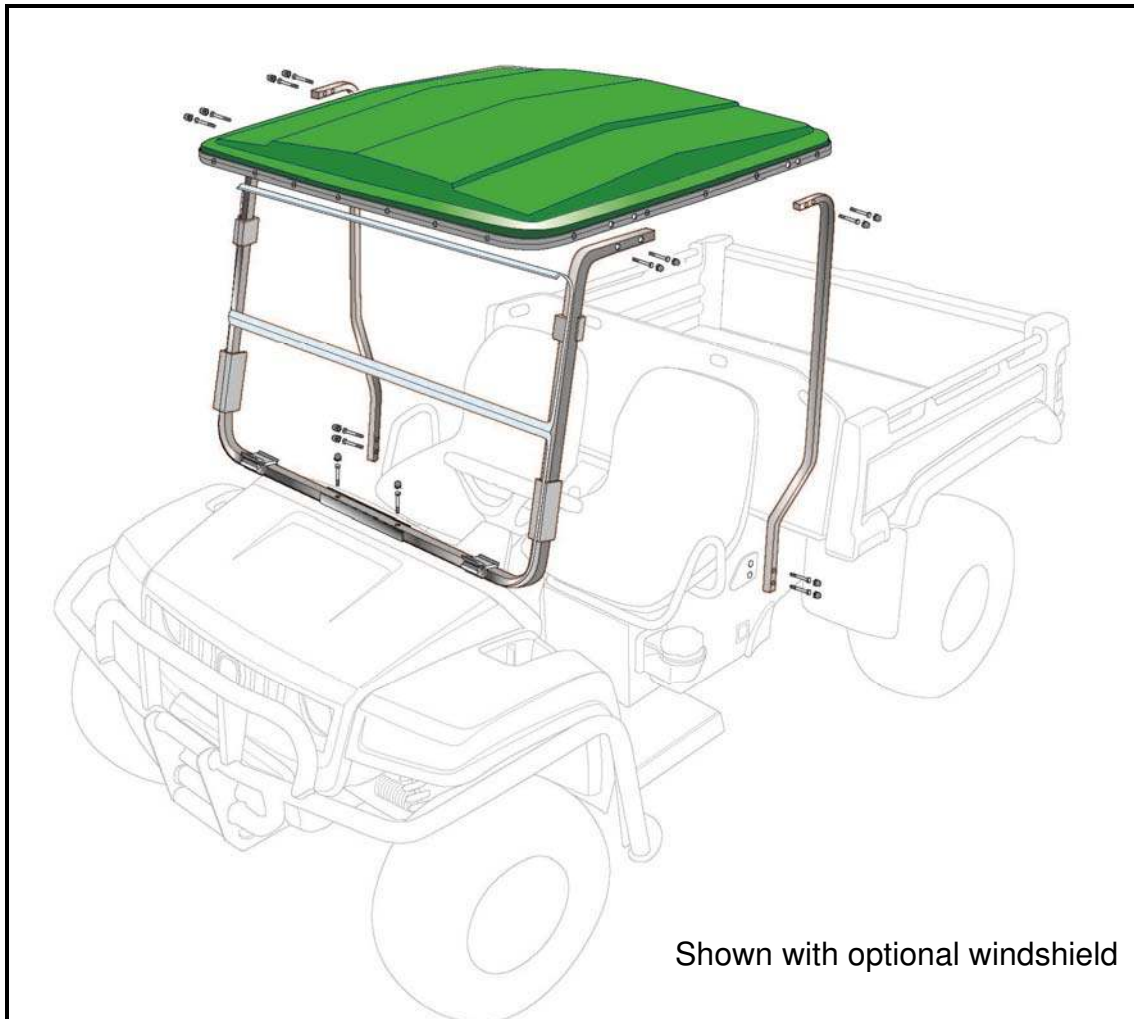

Shown with optional windshield

PARTS IN KIT

CANOPY (9SV-JG07TA)

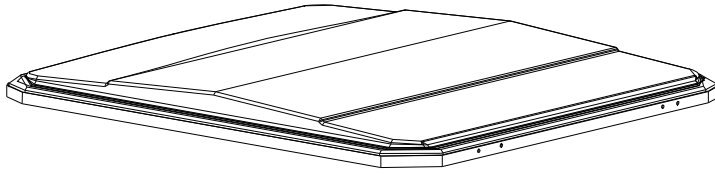

RIGHT REAR
SUPPORT (9SV-JG07R)

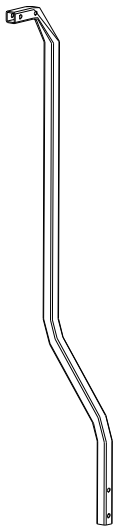

LEFT REAR
SUPPORT (9SV-JG07L)



FRONT FRAME
SUPPORT (9SV-JG07F)

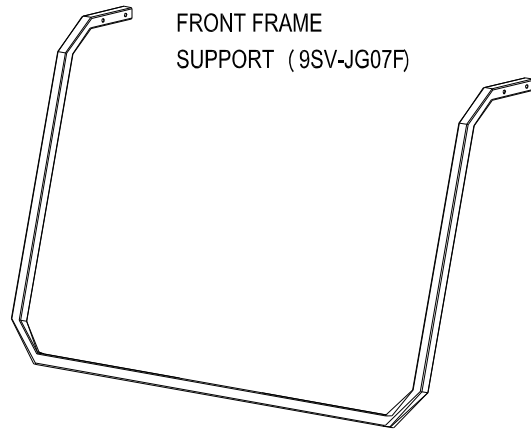

HARDWARE BAG (9SV-JG0714)

INSTRUCTIONS

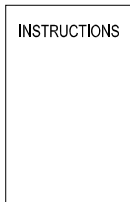

FRONT
MOUNT
CHANNEL

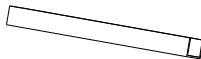



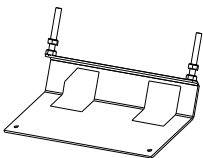



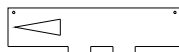



FRONT MOUNT



DRILL TEMPLATE



	1/4-20 X 1-1/2" HH BOLTS	2
	1/4" FLAT WASHERS	10
	1/4" LOCK WASHERS	8
	1/4-20 NYLON LOCKNUTS	2
	7/8" SEALING WASHERS	8
	5/16-18 NYLON LOCK NUTS	6
	5/16-18 X 1-3/4" HH BOLTS	4
	5/16" FLAT WASHERS	4
	1/4-20 X 1-1/2" PH SCREWS	8
	5/16" NUT COVERS	6
	11/16" O.D. NEOPRENE WASHERS	4



NOTICE

Curtis Cabs, blades and general accessories add additional weight to the base vehicle. All Curtis accessory weights are listed in product brochures. Deduct the accessory's total weight from the vehicle's rated capacity and never exceed the vehicle's rated capacity including driver and passenger.

BEFORE YOU START

HELPFUL HINTS:

- A. Refer to parts diagram on the second page of this manual to help identify parts during the assembly process.
- B. To assist with the installation, leave all bolts loose for later adjustment unless otherwise specified.
- C. Read and understand all instructions before beginning.

TOOLS REQUIRED:

- **1/2" and 7/16" sockets**
- **Ratchet**
- **1/2" and 7/16" wrenches**
- **Drill**
- **9/32" drill bit**
- **5/8" drill bit**

Step 1 Prepare Vehicle

- 1.1 Per figures 1.1A and B, remove vehicle hood by grabbing the two outside lower corners at the molded triangle. Pull moderately to release the clips. Lift hood off of vehicle.
- 1.2 Per figure 1.2, position the supplied paper template on the exterior of the hood with the arrow pointing to the left (driver's side). Match up the edge of the template with the rear edge of the hood. Clamp the template in place.
- 1.3 Per figure 1.3, mark and drill two 5/8" holes through the hood.



Figure 1.1A



Figure 1.1B

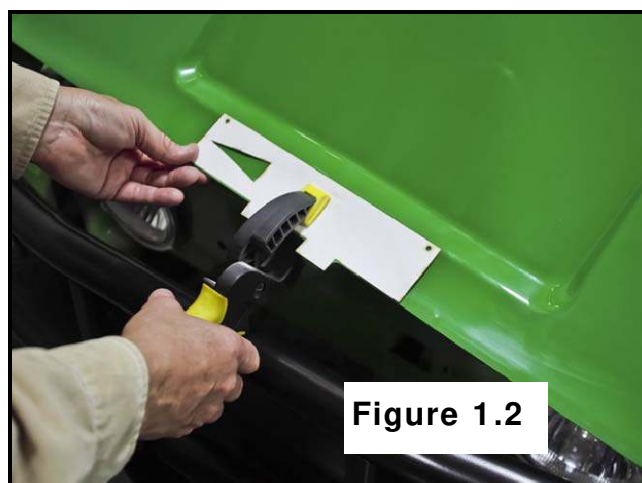

Figure 1.2



Figure 1.3

Step 2 Install Front Mount

- 2.1** Per figure 2.1, locate the front mount between the two center frame rails under the hood. Push the tab on the left side of the bracket (passenger side of the vehicle) against the vertical flange of the passenger side frame rail. Square the bracket to the frame rail and mark the hole locations on the vehicle.
- 2.2** Per figure 2.2, drill two 9/32 holes at the marked locations. **CAUTION:** avoid wiring harness.
- 2.3** Per figure 2.3, fasten each side of the bracket securely to the frame using (2) 1/4"-20 x 1-1/2" bolts, (2) 1/4" flat washers on the bottom side of the vehicle frame, and (2) 1/4" locknuts.

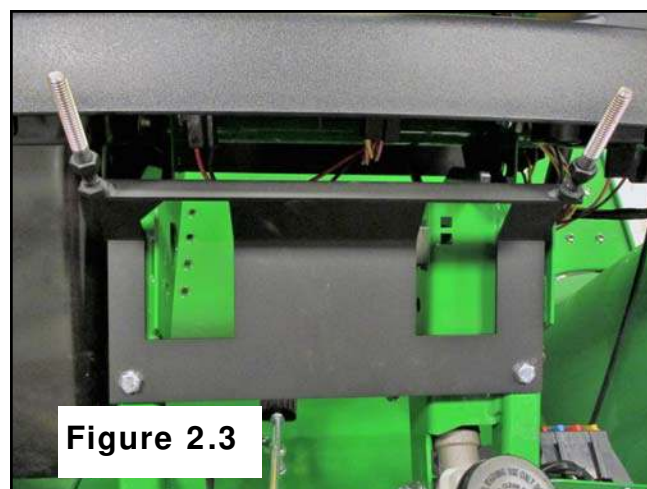
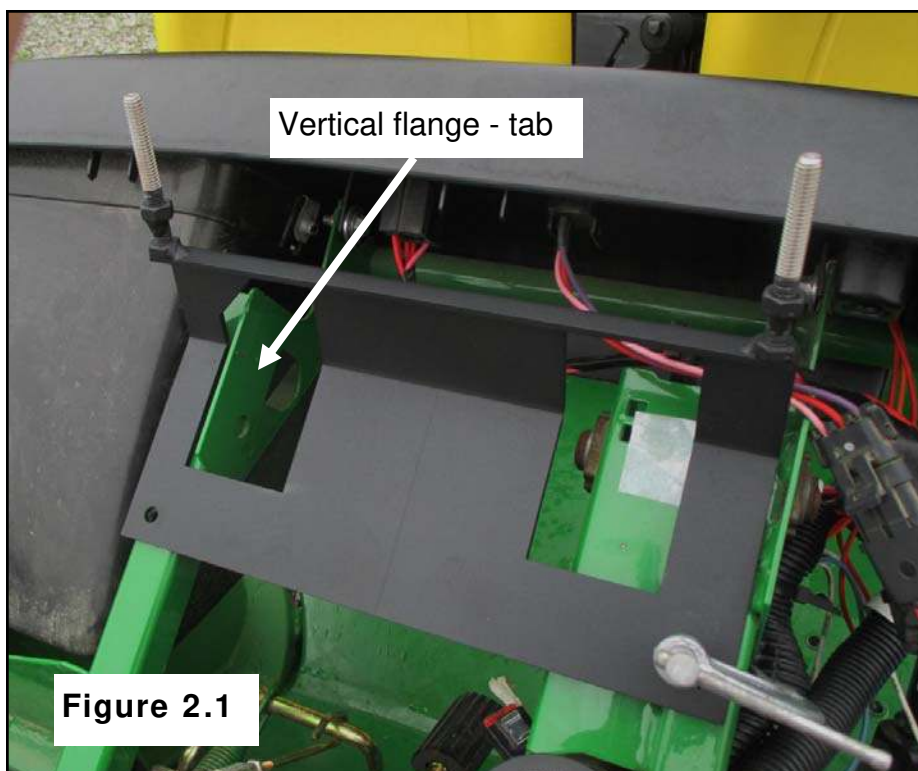

Step 3 Install Hood

3.1 Per figure 3.1, position hood vertically behind the studs of the front mount.

3.2 Per figure 3.2, rotate the hood into position taking care that -

- The rear corners fit in to the groove between the fenders and the dashboard.
- The rear edge goes between the dashboard and the plastic fingers under the dash that hold it against the dash board.
- The hood will need to be bent slightly to get the forward edge behind the bumper.

3.3 Per figure 3.3, confirm the upper nuts on the front mount studs are above the hood. Wiggle the hood around to align the holes in the hood with the nuts if the nuts are pushing on the underside of the hood.

3.4 Push the front corners of the hood at the molded triangles to engage the clips that were disengaged in step 1.1.



Figure 3.1



Figure 3.2



Figure 3.3

Step 4 Install Front Support

4.1 Per figure 4.1, install (2) 7/8" sealed washers rubber side up on the front support studs.

4.2 Per figure 4.2, install front support reinforcing channel onto studs.

4.3 Per figure 4.3.1 and 4.3.2, install the front support frame onto the studs and attach with (2) 7/8" sealing washers (rubber side down) lock nuts and nut covers.



Figure 4.1

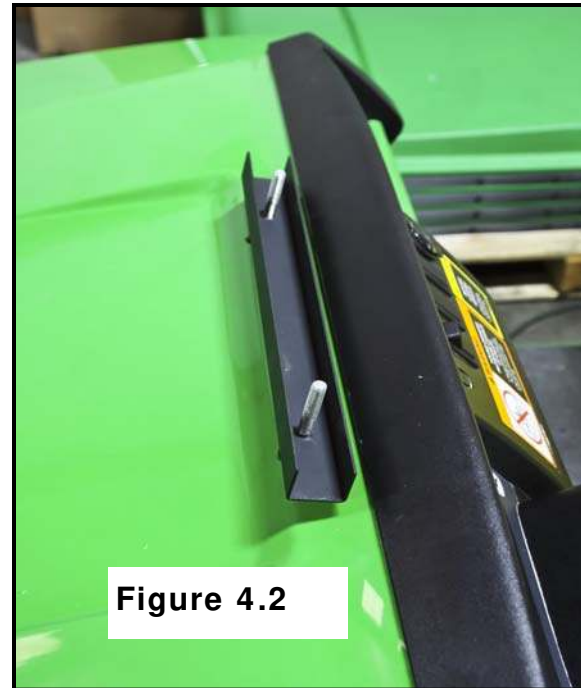

Figure 4.2

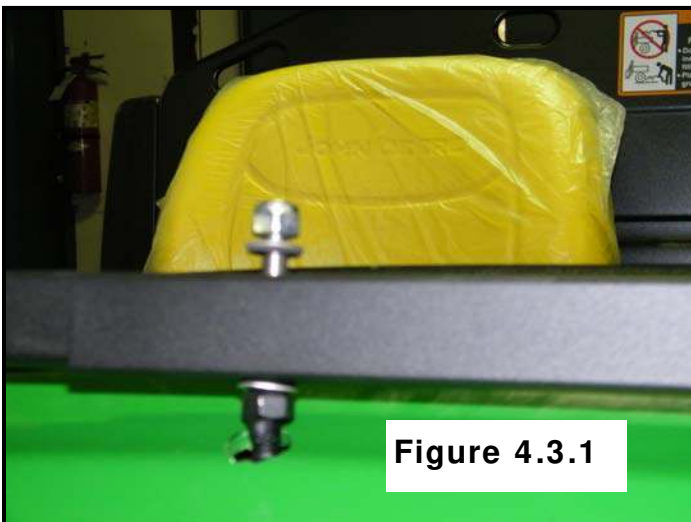

Figure 4.3.1

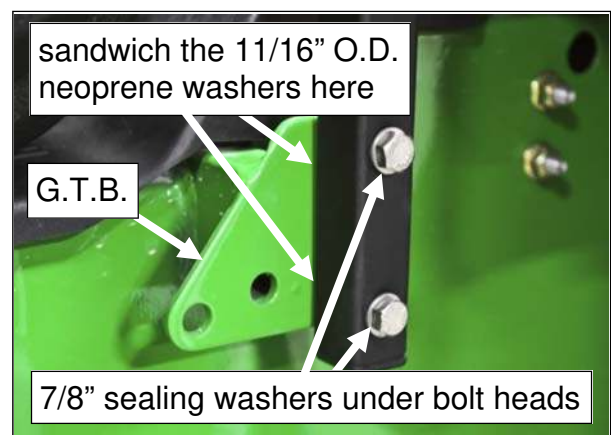
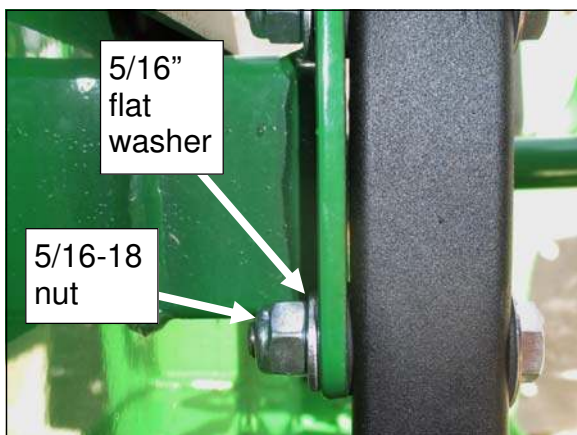
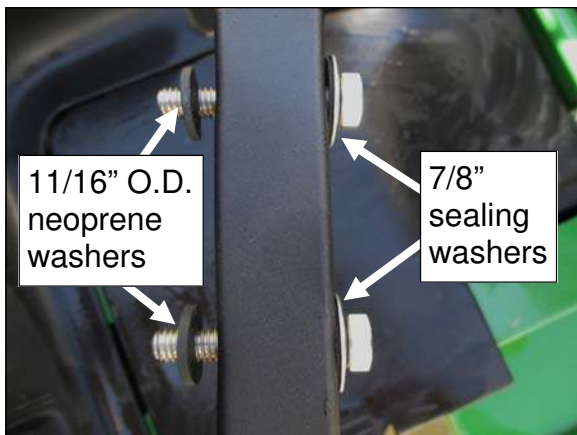
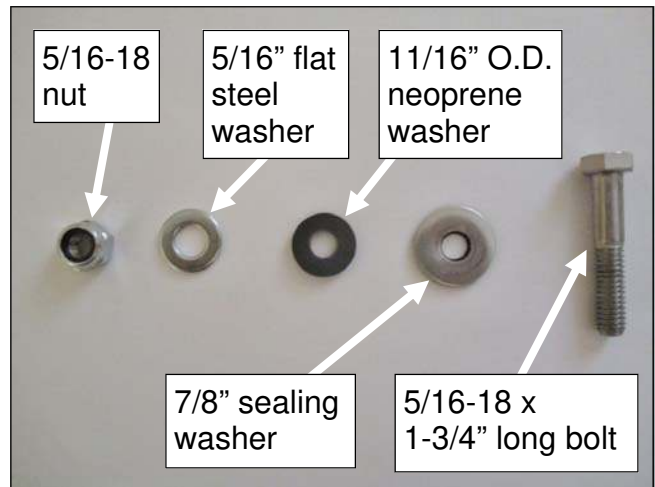

Figure 4.3.2

Step 5 Rear Supports

5.1 Per all the photos on this page, locate the hardware (4 of each shown), locate the green triangular bracket behind and below the seats (labeled G.T.B. in photo). Note: you may have to move the passenger seat forward and readjust after installation.

5.2 Install each Rear Support using two 7/8" sealing washers on the outside of the support tube (under the bolt heads). Place 11/16" O.D. neoprene washer on the inside of the support tube, then the flat steel washer, then the locknut. Leave snug, but not tight, for now.



Step 6 Canopy

- 6.1** Locate the seam on the black band that runs around the perimeter of the canopy. Position the canopy over the supports with the seam oriented toward the back of the vehicle.
- 6.2** Per figure 6.2, install the canopy to the support frames with (8) 1/4 x 1 1/2" PH screws, flat washers and lock washers. NOTE: the canopy has factory installed threaded inserts molded in place.



Figure 6.2

Step 7 Finishing touches

- 7.1** Tighten the nuts on the front mount studs (reference step 4.3). Position the rear supports approximately vertical by pushing forward or rearward on the back of the canopy. Tighten the remaining bolts.
- 7.2** Install plastic covers on all visible canopy nut and bolt heads.