

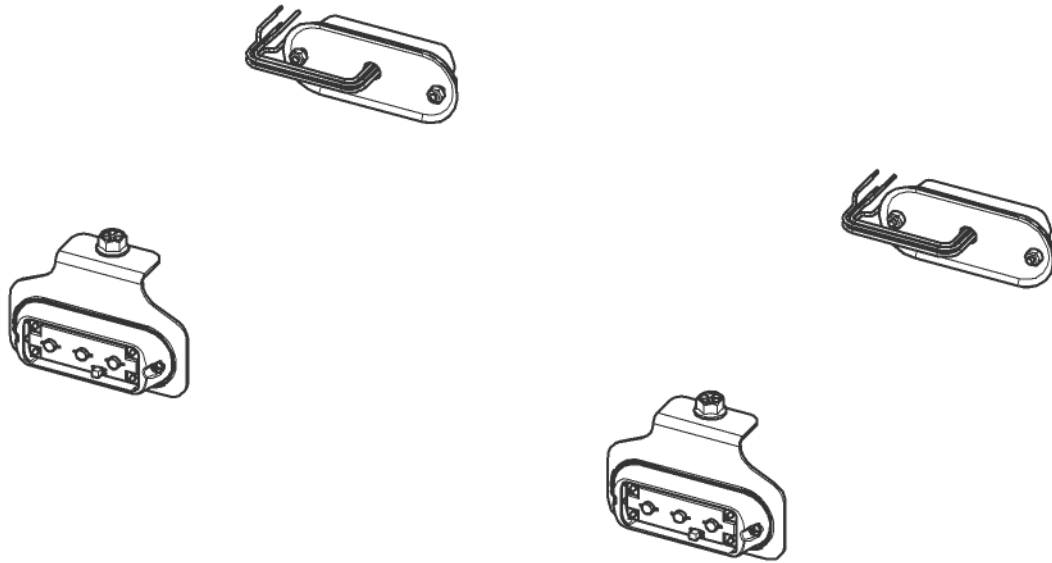

**KAWASAKI MULE Pro FX-FXT  
CORNER FLASHER KIT  
p/n: 1KAPFXCFL**

INSTALLATION & OWNER'S MANUAL



Required Accessories:  
Fuse Panel:  
Kawasaki p/n: KAF080-076  
or  
Curtis p/n: 1KAPFXFP

Approximate Installation Time *
Experienced Dealer Technician – 45 Minutes
Average Dealer Technician – 1 Hour
Do-It-Yourself – 1.25 Hours

Approximate Product Specifications

(\* = Not including accessories)

The contents of this envelope are the property of the owner. Leave with the owner when installation is complete.

## **WARNINGS, TIPS, & REQUIRED TOOLS**

*For accurate installation, proper operation, and years of satisfaction, please read and understand the installation and owner's manual fully prior to installing the accessory.*

*From all of us at Curtis, we thank you for choosing our product.*

### **TOOLS REQUIRED:**

- 5/16", 7/16", and 1/2" wrenches and/or sockets
- #2 Phillips Screwdriver
- Ratchet
- Tape

# INSTALLATION

## 1. Vehicle Preparation:

- 1.1 Park vehicle and engage parking brake.
- 1.2 Remove and discard plugs from roof and windshield support locations marked in figure 1.2.

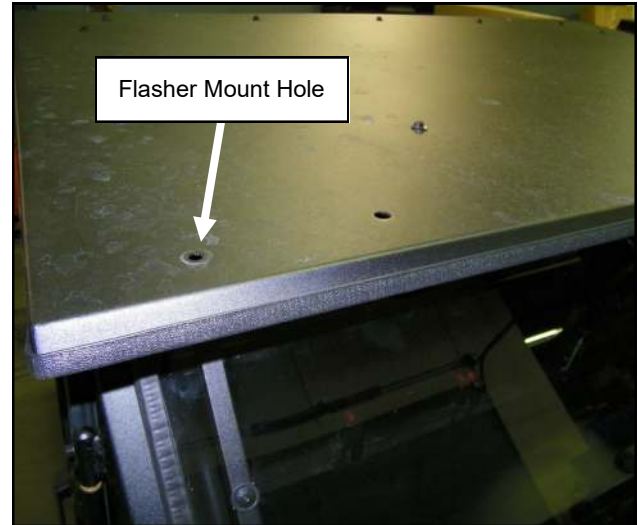

Fig. 1.2

- 1.3 Remove and discard plugs from roof and rear panel in locations shown in figure 1.3.



Fig. 1.3

## 2. Installation:

- 2.1 Feed light wires through the hole in the bracket. Attach light to bracket using #6-32 x 3/4" machine screws and #6-32 nylon locknut provided. As shown in figure 2.1.
- 2.2 Attach bracket on driver's side front of roof by feeding 5/16-18 x 5/8" flanged bolt through bracket and then roof and connecting using 5/16-18 flanged locknut.
- 2.3 Repeat steps 2.1-2.2 for passenger side of vehicle.



Fig. 2.1

# INSTALLATION

- 2.4 Feed wires through hole in driver's side rear of roof. Attach light to roof using #6-32 x 3/4" machine screw and #6-32 nylon locknut provided. As shown in figure 2.4.
- 2.5 Repeat step 2.4 for passenger side of vehicle.

## 3. Wiring:

- 3.1 If not previously removed, remove dash at this time.
- 3.2 Cut out one of the dealer-marked rectangles for switch in dash in position of installer's choosing. See figure 3.2.

**NOTE:** If switch bank is full, then use template on page 11 to cut one 1-1/2" tall by 7/8" wide rectangular hole for switch in location marked in figure 3.2.

- 3.3 Attach switch cover to switch and insert switch into the hole created in step 3.2 being sure that the off position is down, and attach wire harness to switch beneath dash.
- 3.4 Route key power section of wire harness (WH-00017) to the fuse panel located under the hood of the vehicle.
- 3.5 Connect the red 16 Ga wire to the fuse block in a chosen position, and connect the black 16 Ga wire to the grounding block. Shown in figure 3.6.
- 3.6 Attach 10-amp fuse provided to port in the fuse block corresponding with the flasher power harness. Shown in figure 3.6.

**NOTE:** If Kawasaki Fuse Box (p/n: KAF080-076) is installed, use added Curtis wire harness (WH-00011) to connect black ground wire to Kawasaki's grounding post next to fuse box.



Fig. 2.4

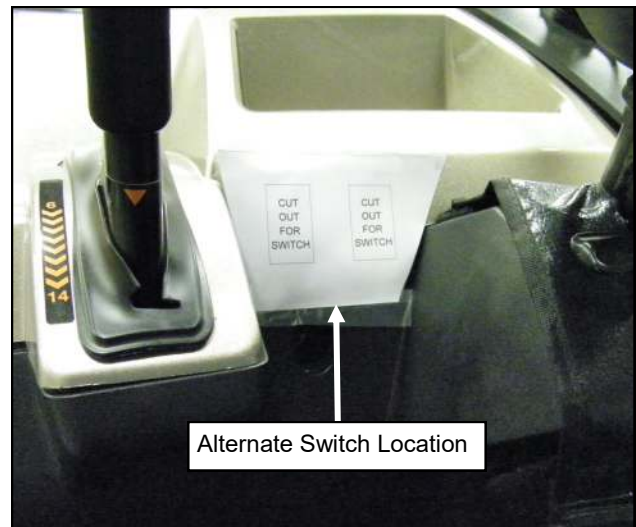

Fig. 3.2

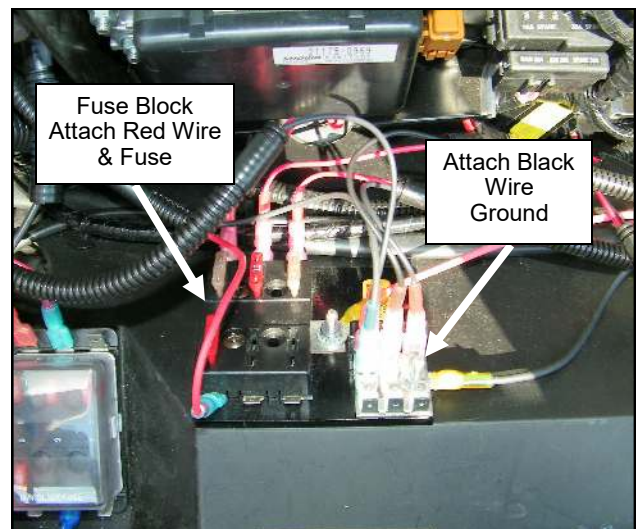

Fig. 3.6

# INSTALLATION

- 3.7 Feed light connections of wire harness around ROPS under dash and out of underside of dash beneath the steering wheel as shown in figure 3.7

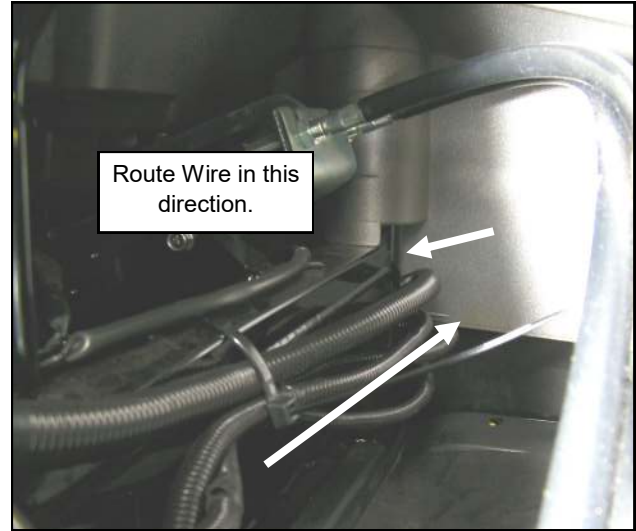

Fig. 3.7

- 3.8 Route harness up flange on side frame of vehicle as shown in figure 3.8.



Fig. 3.8

- 3.9 Feed terminals out of the cab through holes in windshield support. Before connecting, seal hole using rubber grommet (AC1028).
- 3.10 Connect harness to the driver side light on front of vehicle by connecting the bullet terminals on the harness to corresponding terminal on the light.
- 3.11 Route branch for passenger front light across the cab along the windshield support. As shown in figure 3.11.
- 3.12 Repeat steps 3.9 and 3.10 to connect passenger side light.



Fig. 3.11

# INSTALLATION

- 3.13 Loosen bolt connecting cab header to ROPS shown in figure 3.13.



Fig. 3.13

- 3.14 Use tape to secure the shorter portion of harness to longer portion close to the short portion's terminals. Then feed rear portion of harness between ROPS and flange on cab header as shown in figure 3.14. Retighten loosened bolt in step 3.13 at this time.



Fig. 3.14

**NOTE: Steps 3.15-18 are for the Pro-FX or 3-passenger vehicle only. If your vehicle is Pro-FXT or 6-passenger vehicle, skip directly to step 3.19 on the next page.**

- 3.15 Feed the terminals out of the cab between the sealing rubber and the vehicle ROPS.
- 3.16 Connect harness to driver side rear light by connecting bullet terminals on harness to corresponding bullet terminals on light.
- 3.17 Route remaining harness across the rear of the cab following the ROPS as shown in figure 3.17.
- 3.18 Repeat steps 3.15 and 3.16 on the passenger side of the vehicle to connect passenger side light. Take supplied 3/8" Loom cut into 2 equal pieces and attach one piece to the exposed wires on each of the rear flasher lights. **Now skip directly to step 3.28 on page 8.**



Fig. 3.17

# INSTALLATION

- 3.19 Feed bullets for driver's side rear light through the center panel if equipped and connect to extension harness by matching up bullet terminals on the main harness to the extension harness.
- 3.20 Route extension harness (WH-00018) along roof gas shock towards rear panel. As shown in figure 3.20.
- 3.21 Feed terminals from light into cab using the hole in the rear panel support closest to the flasher light. Seal this hole using the rubber grommet (AC1028).
- 3.22 Connect harness to driver side rear light by connecting bullet terminals on harness to corresponding bullet terminals on light.



Fig. 3.20

- 3.23 Route remaining harness across the rear of the cab following the ROPS as shown in figure 3.23.



Fig. 3.23

- 3.24 Feed bullets for passenger side rear light through the center panel if equipped and connect to extension harness by matching up bullet terminals on the main harness to the extension harness.
- 3.25 Route extension harness (WH-00018) along roof gas shock towards rear panel. As shown in figure 3.25.
- 3.26 Feed terminals from light into cab using the hole in the rear panel support closest to the flasher light. Seal this hole using the rubber grommet (AC1028).
- 3.27 Connect harness to driver side rear light by connecting bullet terminals on harness to corresponding bullet terminals on light. Take supplied 3/8" Loom cut into 2 equal pieces and attach one piece to the exposed wires on each of the rear flasher lights.



Fig. 3.25

# INSTALLATION

- 3.28 Turn vehicle to accessory and test to see if lights are working, if they are not, check all the wires and connections.
- 3.29 Once tested, secure all wires using 8" zip-ties provided. See fig. 3.29.

**Note:** For FXT owners, be sure wires are secured to roof and not side frames, otherwise roof will not open properly. See figure 3.29.



Fig. 3.29

## 4. Set Flash Pattern:

- 4.1 Under the hood, locate the section of the wire harness containing the red and yellow wires. Connect the two push-on connectors (short section of harness with yellow and red wires) to the momentary switch. Connect the yellow to tab 3 and the red to tab 2. Zip tie the momentary switch to the vehicle wires under the dashboard. As shown in figure 4.1.
- 4.2 The flashers have multiple flash patterns built into memory and need to be synchronized.
- 4.3 Turn the key on and test the operation of the flashers. With the flasher switch turned on, press and hold the momentary switch for approximately 5 seconds. This will synchronize the flashers to be on the same pattern.
- 4.4 Press the momentary switch once to change the flash pattern. Continue to push the momentary switch until the desired pattern is found.
- 4.5 Once the desired pattern is set, the flashers will retain this setting in memory.
- 4.6 After the flashers are all set-up, secure all wiring to the ROPS tube with the supplied cable ties. Once the switch panel is put back up into place, push any excess wire into the panel.

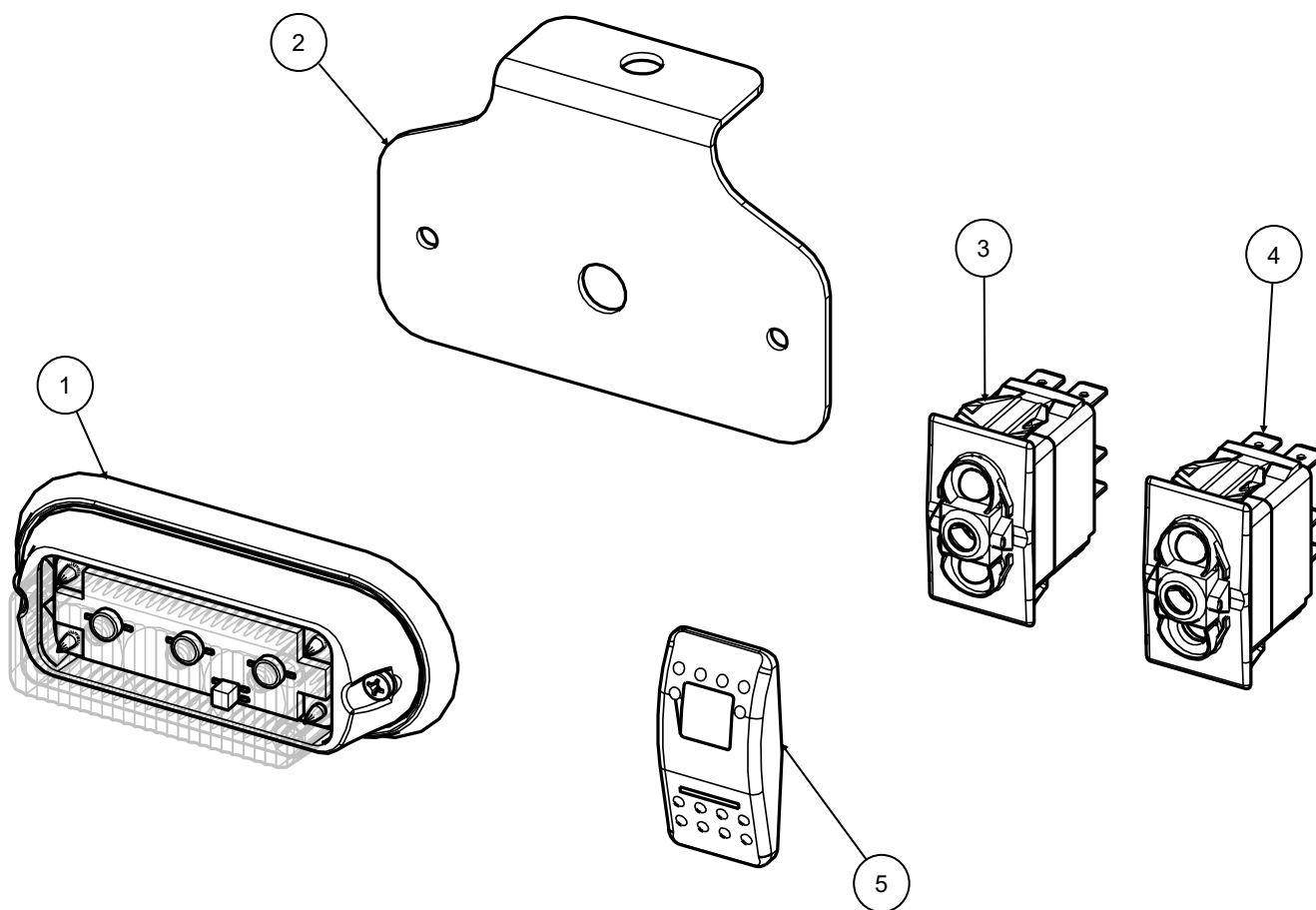

Fig. 4.1



## SERVICE PARTS

#	PART NUMBER	DESCRIPTION	QTY.
1	8SV-LEDSART	3-LED RECT. FLASHER LIGHT W/TERMINALS (AMBER)	1
2	8SV-XUVFFM	FRONT FLASHER BRACKET	1
3	8SV-XUVFLP1	LIGHTED MOMENTARY FLASHER SWITCH	1
4	9SV-OHC5	LIGHTED ON-OFF SWITCH	1
5	9PCD1-N	ROCKER SWITCH COVER, FLASHER SYMBOL (4L)	1
6	9SV-WH00017	WIRE HARNESS, 4-WAY FLASHER	1
7	9SV-WH00018	WIRE HARNESS, 4-WAY FLASHER, EXTENSION	1



Wire Harness Diagrams shown on following page.

# SERVICE PARTS

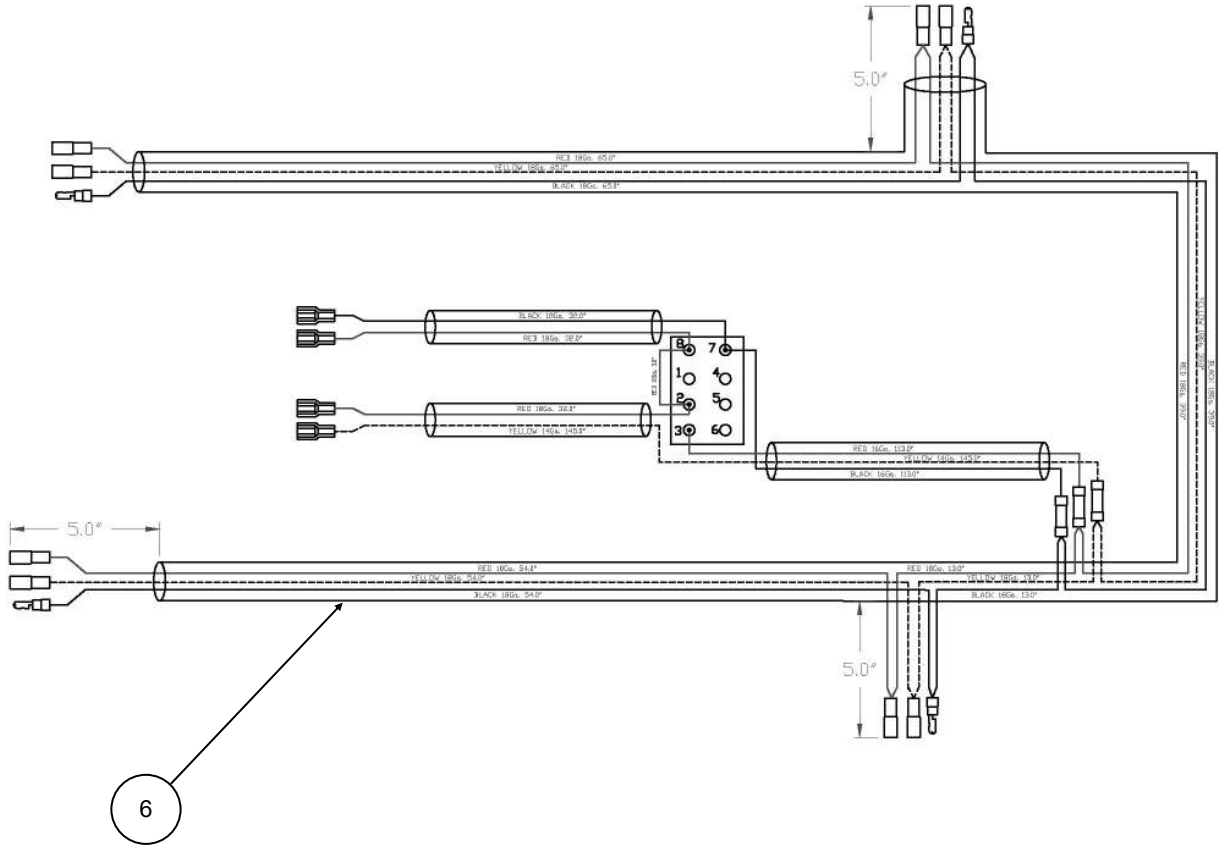

6

7



# SWITCH LOCATION TEMPLATE

Print or copy at 100% scale only (full, 1:1:, Actual Size). Check Dimensions on template before using to verify.

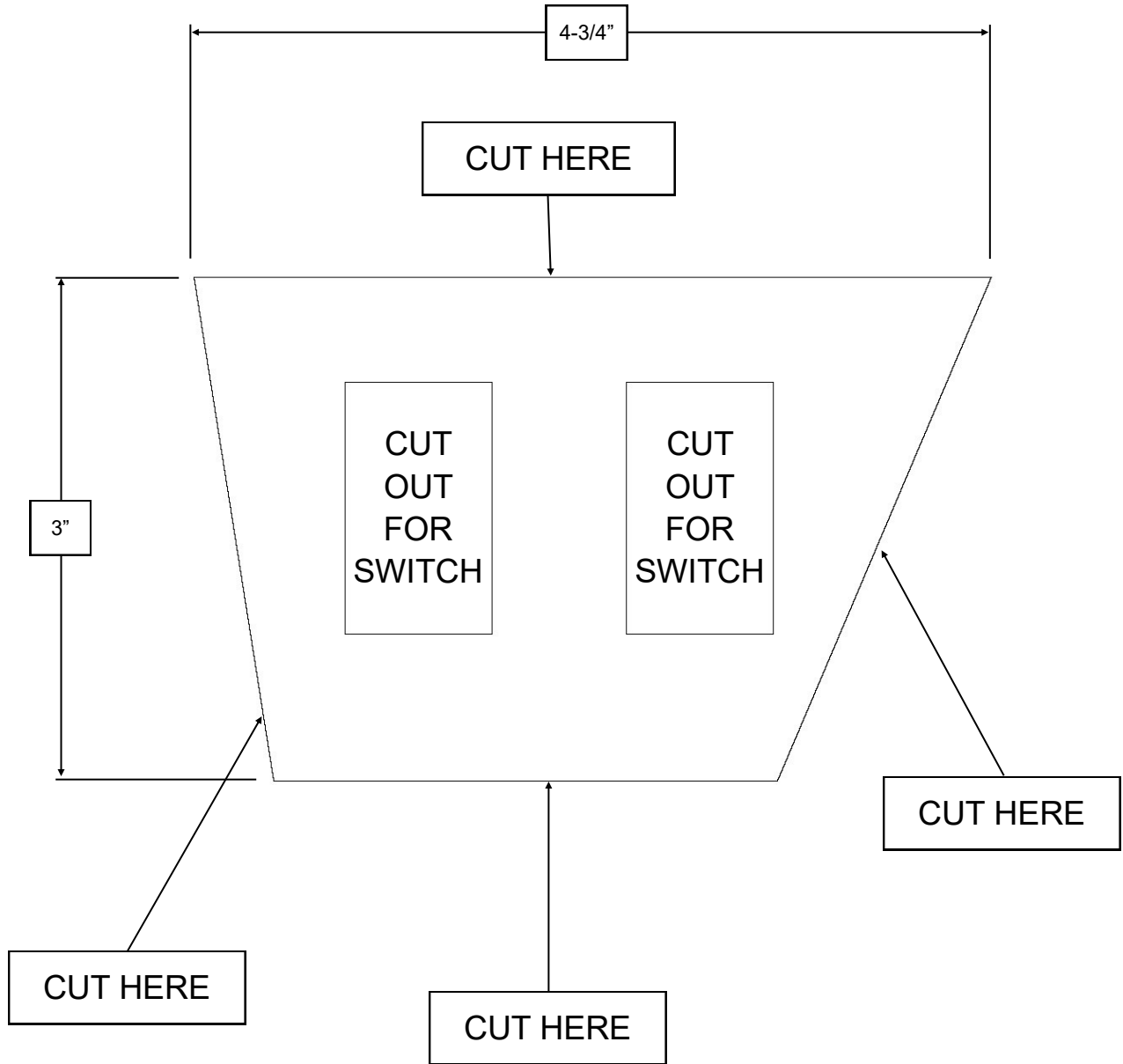



# BOLT TORQUE

## BOLT TORQUE SPECIFICATIONS

### GENERAL TORQUE SPECIFICATION TABLE

Use the following torques when special torques are not given. These values apply to fasteners as received from suppliers, dry, or when lubricated with normal engine oil. They do not apply if special graphited or moly disulphide greases or other extreme pressure lubricants are used. This applies to both UNF and UNC threads. Remember to always use grade five or better when replacing bolts.

**IMPORTANT: On all PLATED GRADE 8 bolts, reduce torque 15% from listed bolt torque specification.**

SAE Grade No.		2				5				8*			
Bolt head identification mark as per grade. NOTE: Manufacturing Marks Will Vary													
		TORQUE		TORQUE		TORQUE		TORQUE		TORQUE		TORQUE	
Bolt Size		Pounds Feet		Newton-Meters		Pounds Feet		Newton-Meters		Pounds Feet		Newton-Meters	
Inches	Millimeters	Min.	Max.	Min.	Max.	Min.	Max.	Min.	Max.	Min.	Max.	Min.	Max.
1/4	6.35	5	6	7	8	9	11	12	15	12	15	16	20
5/16	7.94	10	12	14	16	17	20.5	23	28	24	29	33	39
3/8	9.53	20	23	27	31	35	42	48	57	45	54	61	73
7/16	11.11	30	35	41	47	54	64	73	87	70	84	95	114
1/2	12.70	45	52	61	70	80	96	109	130	110	132	149	179
9/16	14.29	65	75	88	102	110	132	149	179	160	192	217	260
5/8	15.88	95	105	129	142	150	180	203	244	220	264	298	358
3/4	19.05	150	185	203	251	270	324	366	439	380	456	515	618
7/8	22.23	160	200	217	271	400	480	542	651	600	720	814	976
1	25.40	250	300	339	406	580	696	787	944	900	1080	1220	1464
1-1/8	25.58	-	-	-	-	800	880	1085	1193	1280	1440	1736	1953
1-1/4	31.75	-	-	-	-	1120	1240	1519	1681	1820	2000	2468	2712
1-3/8	34.93	-	-	-	-	1460	1680	1980	2278	2380	2720	3227	3688
1-1/2	38.10	-	-	-	-	1940	2200	2631	2983	3160	3560	4285	4827

\*Thick Nuts must be used with Grade 8 bolts

### METRIC BOLT TORQUE SPECIFICATIONS



Size of Screw	Property Class	Course Thread			Fine Thread		
		Pitch (mm)	Pounds Feet	Newton-Meters	Pitch (mm)	Pounds Feet	Newton-Meters
M6	5.6	1.0	3.6-5.8	4.9-7.9	-	-	-
	8.8		5.8-9.4	7.9-12.7		-	-
	10.9		7.2-10	9.8-13.6		-	-
M8	5.6	1.25	7.2-14	9.8-19	1.0	12-17	16.3-23
	8.8		17-22	23-29.8		19-27	25.7-36.6
	10.9		20-26	27.1-35.2		22-31	29.8-42
M10	5.6	1.5	20-25	27.1-33.9	1.25	20-29	27.1-39.3
	8.8		34-40	46.1-54.2		35-47	47.4-63.7
	10.9		38-46	51.5-62.3		40-52	54.2-70.5
M12	5.6	1.75	28-34	37.9-46.1	1.25	31-41	42-55.6
	8.8		51-59	69.1-79.9		55-68	75.9-92.1
	10.9		57-66	77.2-89.4		62-75	84-101.6
M14	5.6	2.0	49-56	66.4-75.9	1.5	52-64	70.5-86.7
	8.8		81-93	109.8-126		90-106	122-143.6
	10.9		96-109	130.1-147.7		107-124	145-168
M16	5.6	2.0	67-77	90.8-104.3	1.5	69-83	93.6-112.5
	8.8		116-130	157.2-176.2		120-138	162.6-187
	10.9		129-145	174.8-196.5		140-158	189.7-214.1
M18	5.6	2.0	88-100	119.2-136	1.5	100-117	136-158.5
	8.8		150-168	203.3-227.6		177-199	239.8-269.6
	10.9		175-194	237.1-262.9		202-231	273.7-313
M20	5.6	2.5	108-130	146.3-176.2	1.5	132-150	178.9-203.3
	8.8		186-205	252-277.8		206-242	279.1-327.9
	10.9		213-249	288.6-337.4		246-289	333.3-391.6