



**KUBOTA B2650/3350
Hard Sided Cab p/n 1KB33AS
Soft Sided Cab p/n 1KB33SS
Installation Instructions**

The contents of this envelope are the property of the owner.
Be sure to leave with the owner when installation is complete.

APPROXIMATE INSTALLATION TIME: 2 to 3 HOURS
(excluding accessories)



Hard sided cab shown with optional work lights, and optional strobe light.
Additional options available are: heater, hard rear panel, and rear window wiper.
Note: a front windshield wiper comes standard with this cab kit.

Revised on: 12-1-2015



CURTIS DESIGN CONCEPT

Curtis cabs feature an assembly of parts designed for your vehicle which require adjustment and alignment of components to accommodate vehicle variations and provide proper weather protection. For accurate installation, proper operation, and years of satisfaction, please read and understand the installation instructions.

From all of us at Curtis, we thank you for choosing our product.

 NOTICE
Curtis Cabs, blades and general accessories add additional weight to the base vehicle. All Curtis accessory weights are listed in product brochures. Deduct the accessory's total weight from the vehicle's rated capacity and never exceed the vehicle's rated capacity including driver and passenger.

⚠ WARNING *Exposure to Carbon Monoxide can Cause illness, serious injury or death. Never operate vehicle if suspicious of Carbon Monoxide. Inspect exhaust system for leaks monthly. Leaks can result from loose connections, corrosion, cracks or other damage to the exhaust manifold. If leaks are found, repair or replace exhaust system. Do not use vehicle until repair or replacement is complete.*

⚠ WARNING	
Serious Injury or Death	
	This cab enclosure does not provide protection from rollover or other accidents.
	This cab enclosure does not provide protection from flying objects including golf balls.
	This cab enclosure does not provide protection from lightning. When lightning threatens take cover and do not operate vehicle.

CAB INSTALLATION

BEFORE YOU START

HELPFUL HINTS:

- A. Refer to parts diagram toward the back of this manual to help identify parts during the assembly process.
- B. To assist with the cab installation, leave all bolts loose for later adjustment unless otherwise specified.
- C. Read and understand all instructions before beginning.
- D. Plastic washers have been supplied to provide a weather seal under the heads of all exterior bolts. The plastic washer should be installed under each bolt head directly against the outside cab surface. Care should be taken not to over tighten the fasteners and damage the plastic washer. Also use steel washers as required. See diagram.
- E. Apply a silicone sealant to seal any minor gaps that may occur due to vehicle variations.
- F. Use caution to avoid damaging the factory installed threaded inserts. Begin the bolt engagement by hand to avoid or correct potential cross threading.

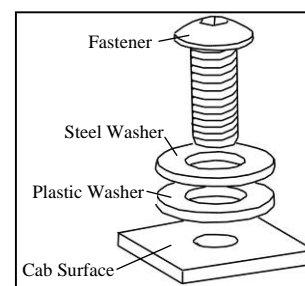

TOOLS REQUIRED

Set of standard and metric sockets
 Set of standard and metric open end wrenches
 Drill
 3/8" drill bit
 Measuring Tape
 Clamp

One Phillips Head Screwdriver
 Scissors
 One 3/8" Drive Ratchet
 One 5/32" Allen Wrench (preferably "T" handle type)
 One 3/16" Allen Wrench (preferably "T" handle type)

1. VEHICLE PREP

1.1 Per fig. 1.1, remove the following five (5) items from the tractor: the optional tool box and clamps from the roll bar (if equipped), both grab handles, and both turn signal lights from the fenders (identify the wires for easier re-connection later). Save the turn signal lights, washers, and nuts for re-use in step 13.

2. ROLL BAR BRACKETS

2.1 Per fig. 2.1, loosely install the roll bar brackets and the roll bar mounts to the R.O.P.S. tubing (two places per upright) (approximately where shown in relationship to the removable pin for the fold-down R.O.P.S.). Ref.: the center of the bolt hole should be approximately 14-1/2" up from the fender and 36-1/2" up from the fender. When left loose, these units will be able to slide up or down to match the exact mounting holes in the back of the side frames. Orient as shown for the right side and opposite for the left side. Use the following hardware per setup: one 5/16" x 1" long carriage bolt and one locknut. The locknut is to be towards the outside of the tractor.



Fig. 1.1 (remove these items from tractor)

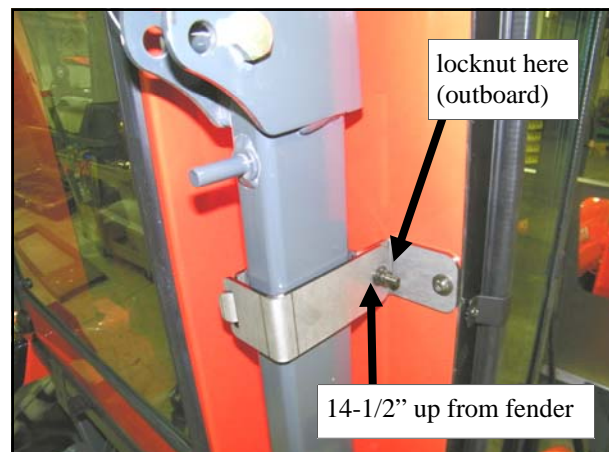

Fig. 2.1 (roll bar bracket on right side of vehicle)

3. HARD REAR PANEL

Note: this is a separately purchased option on soft sided cabs. It's a standard included item on hard sided cabs. If installing on a SS cab, remove snaps from rear edge of roof.

3.1 If not installing a hard rear panel, skip to step 4 below.

3.2 See fig. 3.2. With assistance, place the hard rear panel on the tractor in front of the R.O.P.S. tubing oriented as shown with the window towards the rear. The bulb rubber on the bottom of the left and right sides should be pointing forward. NOTE: per the inset picture in the top left hand corner of fig. 3.2, be sure both removable pins for the fold-down R.O.P.S. are oriented for easy outboard pin removal once the optional hard rear panel is bolted in place.

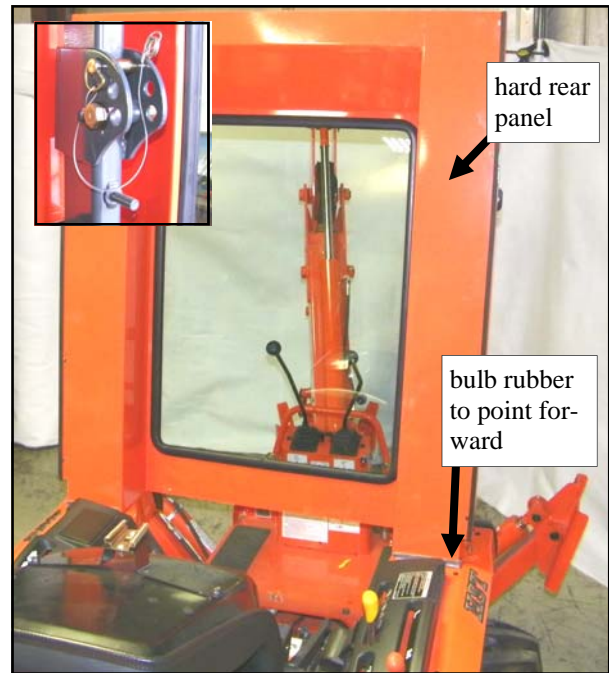

Fig. 3.2 (view from front left side of tractor)

4. COWL

4.1 Per fig. 4.1, position the cowl over the hood of the tractor oriented so the top channel bend is towards the rear of the tractor (fig. 5.1.1 also shows the orientation). The bulb rubber seal around the hood area should be positioned to point towards the seat. As shown in fig. 5.1, the lower bent flange on the cowl sits on top of the rubber floor mat (not under it).

5. SIDE FRAME

For ease of installation, remove the doors from side frames by opening and lifting up off of pin hinges with the aid of an assistant.

5.1 Per fig. 5.1, install the left side frame so the floorboard sits on top of the rubber floor mat and on top of the bent flange on the lower portion of the orange cowl as shown. Per fig. 5.1.1, the mounting tab that is welded on to the side frame fits into the bent channel on the cowl as shown. The bulb rubber that seals against the rear fender should be pointing outboard to minimize covering the factory installed decals.



Fig. 4.1 (view from front left side of tractor)

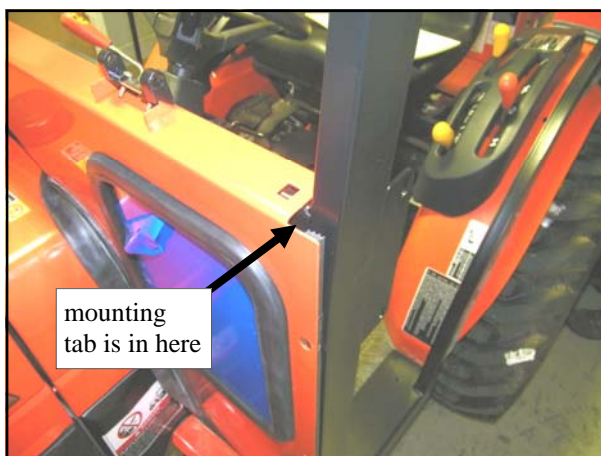

Fig. 5.1.1 (view from front left side of tractor)



Fig. 5.1 (view from rear left side of tractor)

5. SIDE FRAME (cont'd.)

5.2 Per fig. 5.2, use the following hardware installed horizontally into the front of the side frame tubing (into factory installed threaded inserts): three 5/16 x 3/4" long button head bolts, three nylon washers, and three steel washers. See helpful hint "D" on page 2 for proper placement of nylon/plastic washers. **Use caution** to avoid damaging the factory installed threaded inserts. Begin the bolt engagement by hand to avoid or correct potential cross-threading. Do not tighten bolts.



Fig. 5.2 (view from front left side of tractor)

5.3 Per fig. 5.3, clamp the top corner of the cowl to the side frame to assist in lining up the holes for the vertical bolt. Use the following hardware in this location: one 5/16 x 3/4" long button head bolt, one steel washer, and one locknut. The head of the bolt is to be up top as shown. Tighten bolt and remove clamp.



Fig. 5.3 (view from front right side of tractor)

5.4 Per fig. 5.4, attach the back side of the side frame to the roll bar bracket assembly. Note: fig. 5.4 shows an optional hard rear panel in place. Use the following hardware in each of the four roll bar bracket assemblies: one 5/16 x 1" long button head bolt, one nylon washer, and one steel washer. Thread into the factory installed threaded inserts in the rear of the side frame tubing. Do not tighten bolts.

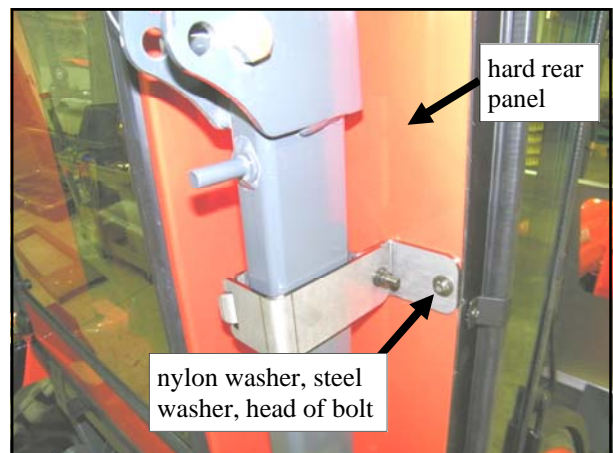

Fig. 5.4 (view from rear right side of tractor)

5.6 Repeat all of section 5 for the opposite side frame.

5.7 Per fig. 5.7, new decals can be obtained from Kubota and repositioned on the tractor if required.



Fig. 5.7 (view from center of tractor)

6. WINDSHIELD SUPPORT

6.1 See fig. 6.1. With assistance, install the windshield support to the top front corner of the side frames oriented as shown with the bent flanges on the bottom. In the lower holes only, use the following hardware per side frame: one 5/16 x 1" long button head bolt, one steel washer, one nylon washer, and one locknut. Refer to the helpful hints section on page two for the proper placement of the nylon washer. Do not tighten bolts. Note: the upper hole on each side will get hardware once the roof is installed.

7. WINDSHIELD

7.1 See fig. 7.1. Have the following items ready: four 5/16 x 1-3/4" long flat head bolts, four locknuts, and two plastic spacer blocks. With assistance, install the windshield hinges to the windshield support with the two spacer blocks between the hinge and the windshield support. Attach windshield latches to windshield latch receivers on the cowl by squeezing tabs to retract spring loaded pins. See fig. 7.1.1. Lift up on bottom of windshield and close latches. Check alignment of windshield with side frames and tighten hinge hardware. **CAUTION: hinges are plastic components. Do not over-tighten hardware. Torque to 7 foot-pounds maximum.** Also tighten both lower windshield support bolts (from step 6 above).



Fig. 6.1 (view from front left side of tractor)

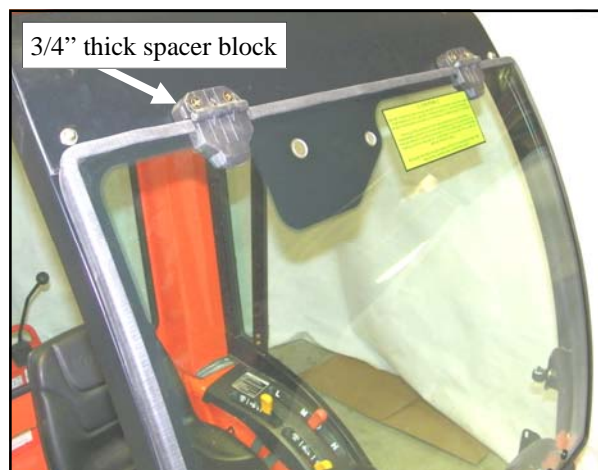

Fig. 7.1 (view from front right side of tractor)



Fig. 7.1.1 (view from center of tractor)

8. ROOF

8.1 Use a Phillips head screwdriver to punch a hole through the headliner at any of the covered bolt hole locations (8 places). Punch holes from the inside out to avoid having the headliner pull away from its glued surface.

8.2 Install the roof oriented so the reflectors are towards the rear of the vehicle. Use the following hardware in the two front corners: one 5/16 x 1" long button head bolt, one steel washer, one nylon washer, and one locknut (locknuts on the inside surface). Install the bolt through the roof, windshield support, and mounting tab. See the helpful hints section on page two for placement of nylon washers.

8.3 See fig. 8.3. The middle side and rear corner bolt location on both the left and right sides uses the following hardware per side: two 5/16 x 3/4" long button head bolts, two steel washers, and two nylon washers. These bolts are installed into factory installed threaded inserts in the top of each side frame. **NOTE:** use caution to avoid damaging the internal threads on the factory installed threaded inserts.

8.4 The remaining two holes in the middle front use the following hardware: two 5/16 x 3/4" long button head bolts, two steel washers, two nylon washers, and two locknuts. Locknuts to be on the inside surface.

9. TIGHTEN ALL BOLTS

9.1 Tighten all bolts at this time including the carriage bolts on the roll bar brackets, etc.. Note: the roll bar brackets should end up parallel and/or perpendicular to the R.O.P.S. tubing.

9.2 Per figures 9.2 and 9.2.1, use the two holes in the side frame floorboard as a guide to drill 3/8" diameter holes through the floor of the tractor. **WARNING: check underneath for obstructions before drilling.** With assistance, depress the inner-most brake pedal to gain clearance for the drill to be vertical when drilling the front right bolt hole. Install the following hardware per side: two 5/16 x 1" long button head bolts, two steel washers, and two locknuts. Locknuts to be underneath the tractor. Tighten these bolts.

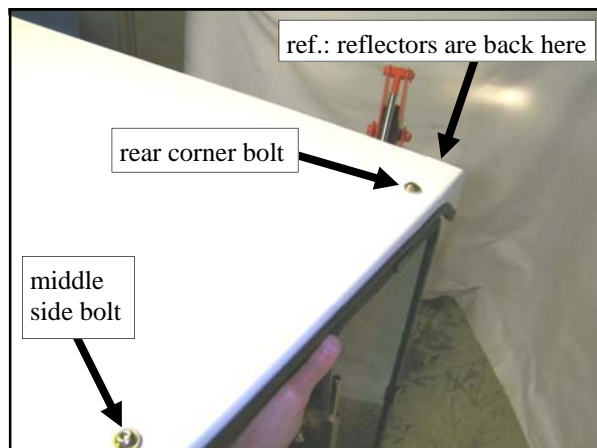

Fig. 8.3 (view from front left side of tractor)



Fig. 9.2 (view from seat of tractor)

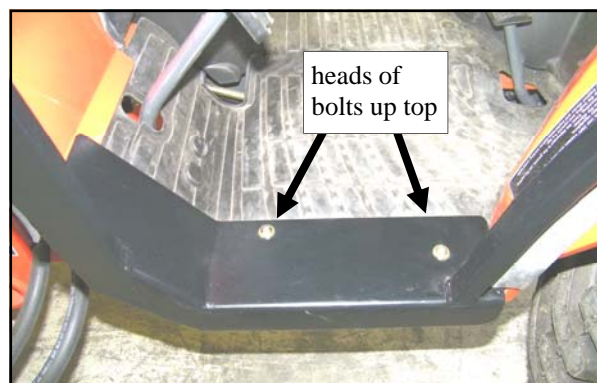

Fig. 9.2.1 (view from left side of tractor)

10. REAR CURTAIN

If installing a hard rear panel, skip this step and continue with step 11 below.

10.1 Assemble the six (6) snaps on the rear curtain to the six (6) snaps on the back side of the roof.

10.2 Dry fit the sides of the rear curtain to the wide inner surface of the side frame rear vertical tubing as shown in fig. 10.2. Install the supplied 1" wide hook velcro to a clean, dry surface at room temperature for best adhesion. Attach the curtain to the newly installed velcro.

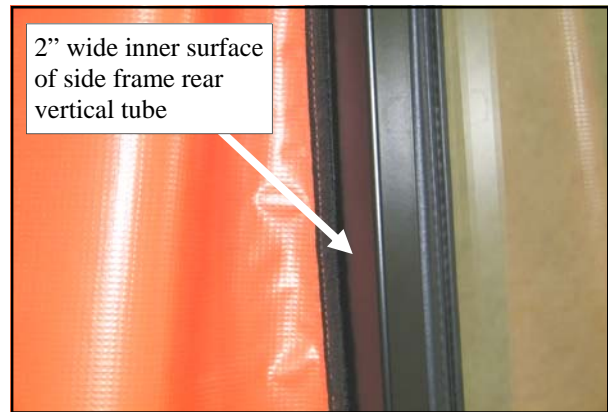

Fig. 10.2 (view from center of tractor)

11. UNDER SEAT FILLER

11.1 Per fig. 11.1, tip/raise the seat forward and position the under seat vinyl filler as shown with the seat belt bracket passing through the slit openings on each side. Dry fit this and estimate where to apply the supplied 1" wide hook velcro to the fenders, etc.. Reminder: for best adhesion, apply self-adhesive backed velcro to clean, dry surfaces at room temperature. The top middle section of the under seat filler attaches to the bottom of the soft rear curtain or to the bottom inside surface of a hard rear panel as shown in fig. 11.1.1. For the hard rear panel, install more of the supplied 1" wide velcro to suit.

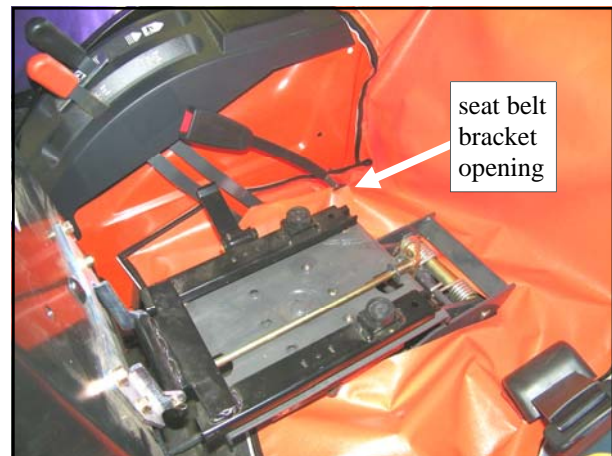

Fig. 11.1 (view from left side of tractor)

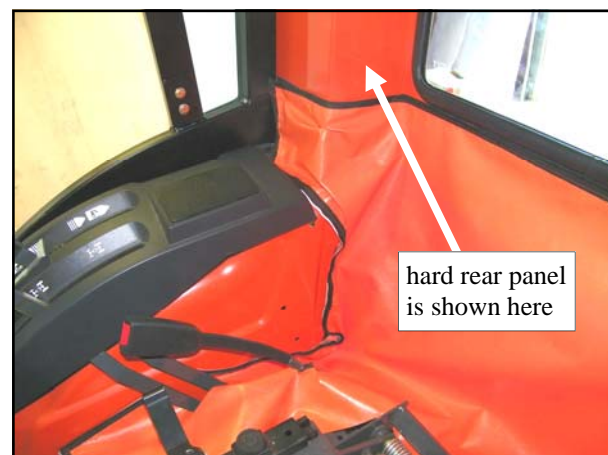

Fig. 11.1.1 (view from left side of tractor)

12. DOORS

12.1 Apply grease to the pin hinges. With assistance, re-install the doors onto the pin hinges. Work the doors back and forth until the hinges are completely seated. If necessary, specific adjustments can be made per the steps below. Note: the top of the door should end up visually parallel with the side of the roof. Note: the door latch is a rotary type with two positions to close. Adjust door so that when fully closed door latch clicks **twice** for total engagement.

Per fig. 12.2, the large striker bolt and nut can be loosened and reset higher or lower, in or out for better engagement and door seal. Use two 19mm open end wrenches. Note: finger guard to end up being centered and facing inward.

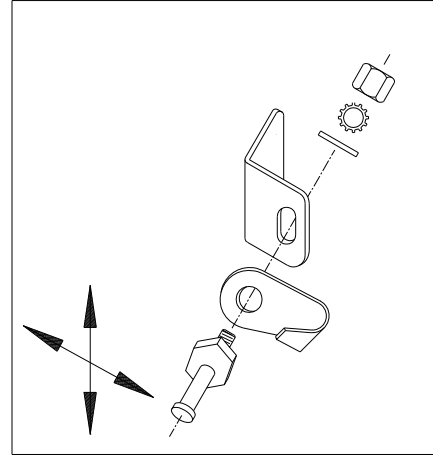

Fig. 12.2 (view of striker bolt assembly)

Per fig. 12.3, the 1/4" hex head bolts on the door hinges can be loosened on the rear tube, or on the door itself, or in both places, in order to rotate or move the door up or down and forward or backward as necessary for proper alignment with side frame. Note: An assistant will be needed for this step. Keep the hinge sleeves fully seated on the pin hinges. Tighten all hinge bolts using caution to **not** over tighten. Over tightening will crush (damage) the structural tubing. **Torque to 40 inch-pounds.**

Per fig. 12.4, the inside latch can be moved forward or back for proper engagement with the striker bolt. Loosen the two hex head bolts shown to move the latch. Re-tighten bolts.

CAUTION: FOR SAFE OPERATION, DO NOT DRIVE WITH DOORS OPEN. MAKE SURE DOORS ARE CLOSED AND PROPERLY LATCHED WHEN DRIVING.

For soft sided doors, install the supplied vinyl coated cable door stops between the upper bracket on the doors and the upper bracket on the side frames. Use the following hardware: four 5/16 x 3/4" long hex head bolts, eight steel washers, and four locknuts. Do not tighten down firmly. Allow for free pivoting.

For hard sided doors, install the supplied gas shocks to the factory installed ball studs on the side frames and doors with the small piston end towards the door.

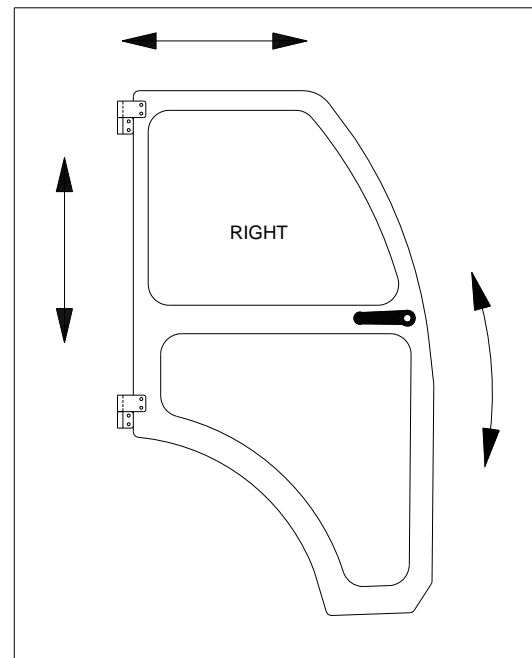

Fig. 12.3 (exterior view of right side door)



Fig. 12.4 (interior view of right side door latch)

13. TURN SIGNAL LIGHTS

13.1 Per fig. 13.1, re-install the turn signal light to the welded bracket on the back side of the side frames. Use the supplied wires to connect to the existing wiring underneath the fender (see fig. 13.1.1). Repeat for opposite side.

14. WINDSHIELD WIPER

14.1 Install the wiper motor per the installation instructions included with the wiper kit.

15. FINISHING TOUCHES

15.1 Peel protective film from the windows.

15.2 Install the supplied nut covers on the interior lock-nuts (qty.: 20).

16. CARE AND MAINTENANCE

16.1 Once the doors are properly adjusted, lubrication (preferably grease) can be applied to the striker bolts and door latch assemblies. Re-apply periodically as needed (same goes for the door pin hinges as necessary).

16.2 Check and tighten hardware after 40 hours of operation. Periodically inspect and tighten hardware for the remainder of the unit's life.

16.3 Wash the painted surfaces of the unit with commercial automotive cleaning products.

16.4 Clean windows with glass cleaner.

16.5 Vinyl components should be washed with a mild solution of warm soapy water.

16.6 Clear vinyl can be easily scratched. Be careful cleaning frost or snow from rear curtain. Do not roll curtain in cold weather. The curtain becomes stiff and may crack. Keep curtain clean.



Fig. 13.1 (view from rear left side of tractor)

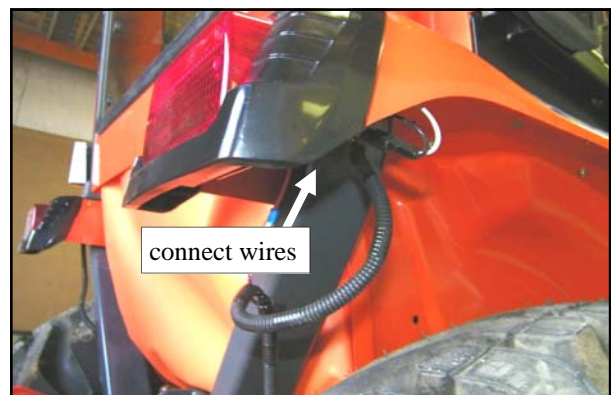
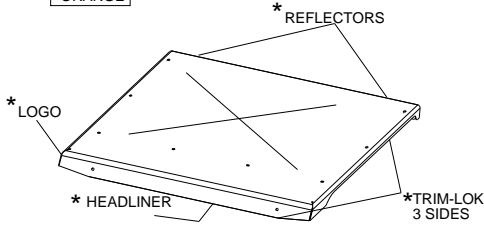

Fig. 13.1.1 (view from rear right side of tractor)

KUBOTA B2650 HARD SIDED CAB PARTS LIST

ROOF	QTY.	P/N
ORANGE	1	8SV-KB2301A-O3



WINDSHIELD	QTY.	P/N
ORANGE	1	8SV-KU302

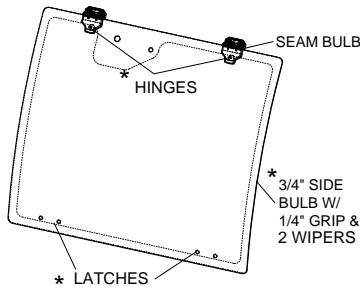

ROLL BAR MOUNTS	QTY.	P/N
RAVEN T1	4	8SV-KB3305-B4

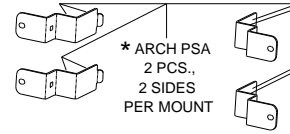

WINDSHIELD SUPPORT	QTY.	P/N
RAVEN T1	1	8SV-KB2303-B4

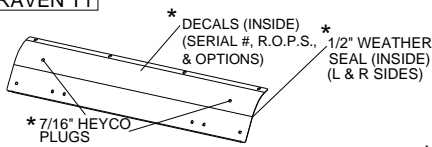

COWL	QTY.	P/N
ORANGE	1	8SV-KB3304-O3

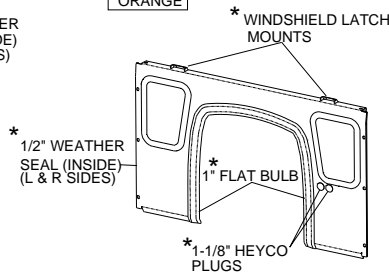

ROLL BAR BRACKET	QTY.	P/N
RAVEN T1	4	8SV-KB3312-B4

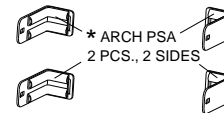

RUBBER TYPES:	
3/4" SIDE BULB (20')	
9SV-PR17-20	
1/2" WEATHER SEAL (10')	
9SV-PR20-10	
TRIM LOK (10')	
9SV-PR01-10	
3/4" SIDE BULB W/ 1/4" GRIP & 2 WIPERS (15')	
9SV-PR38-15	
1" FLAT BULB	
9SV-PR05-10	
7/16" SIDE BULB W/ 1/4" GRIP & 2 WIPERS (15')	
9SV-PR29-15	
ARCH PSA (10')	
9SV-PR09-10	

SIDE FRAMES	QTY.	P/N
RAVEN T1	LEFT 1	8SV-32AS9L-B4
	RIGHT 1	8SV-32AS9R-B4

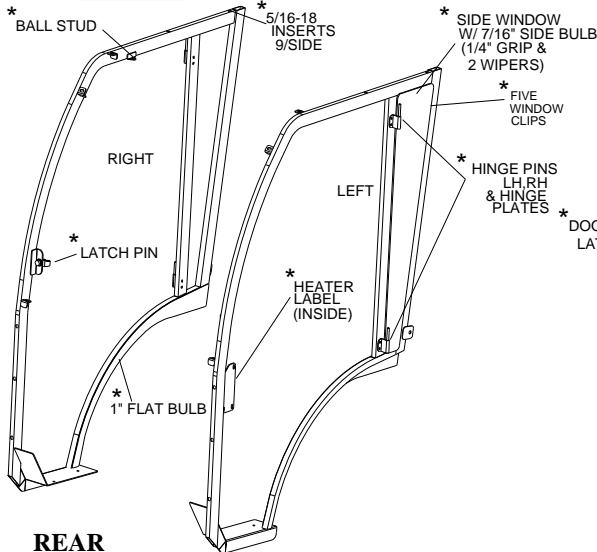

HARD DOORS	QTY.	P/N
ORANGE	LEFT 1	8SV-32AS7L-O3
	RIGHT 1	8SV-32AS7R-O3

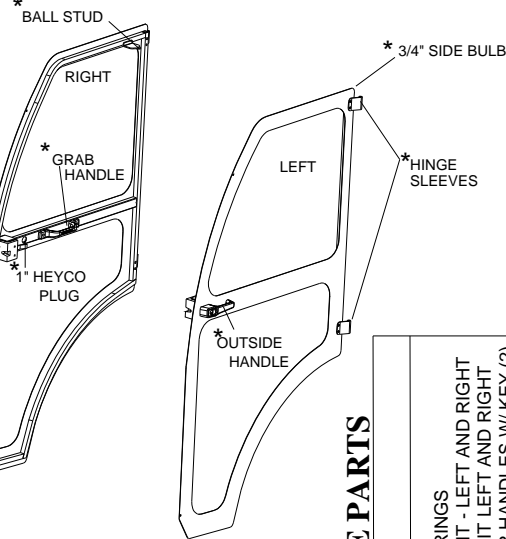

REAR PANEL	QTY.	P/N
ORANGE	1	8SV-KB3206-O3

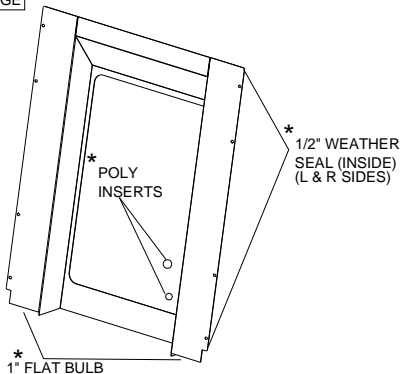

UNDER SEAT FILLER	QTY.	P/N
ORANGE	1	8SV-KB3310-VK

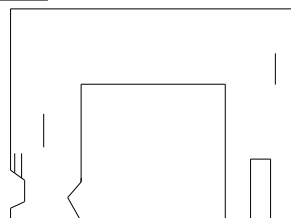

ADDITIONAL SERVICE PARTS

QTY./UNIT	P/N	DESCRIPTION
1	9SV-CS02	DOOR GAS SPRINGS
1	9SV-HDR1	DOOR HINGE KIT - LEFT AND RIGHT
1	9SV-IHRL	DOOR LATCH KIT LEFT AND RIGHT
1	9SV-OHRL	OUTSIDE DOOR HANDLES W/ KEY (2)
1	9SV-GH	GRAB HANDLE KIT (2 HANDLES)
1	8SV-SWC2L	LEFT DOOR SLIDING WINDOW
1	8SV-SWC2R	RIGHT DOOR SLIDING WINDOW
1	9SV-WL1	WINDSHIELD LATCH KIT (2 LATCHES)
1	9SV-HWS	WINDSHIELD HINGE KIT (2 HINGES)
1	KB33HWK-01	HARDWARE KIT (CAB)
1	KB32HWK-02	REAR PANEL HARDWARE KIT
1	8SV-PGB33CWL	COWL WINDOW

*IN HOUSE APPLICATIONS

KUBOTA B2650 SOFT SIDED CAB PARTS LIST

ROOF QTY. P/N
1 8SV-KB2301-O3

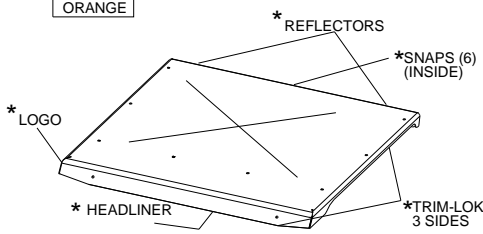

WINDSHIELD QTY. P/N
1 8SV-KU302

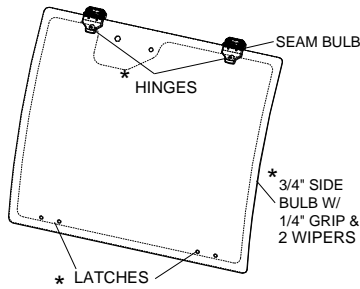

ROLL BAR MOUNTS QTY. P/N
4 8SV-KB3305-B4

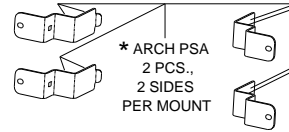

WINDSHIELD SUPPORT QTY. P/N
1 8SV-KB2303-B4

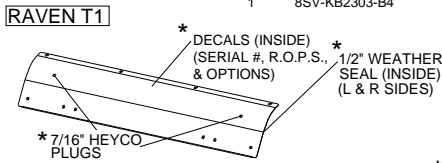

COWL QTY. P/N
1 8SV-KB3304-O3

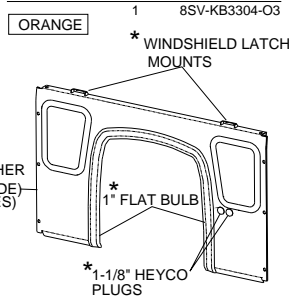

ROLL BAR BRACKET QTY. P/N
4 8SV-KB3312-B4

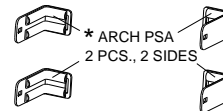

SIDE FRAMES QTY. P/N
LEFT 1 8SV-32SS9L-B4
RIGHT 1 8SV-32SS9R-B4

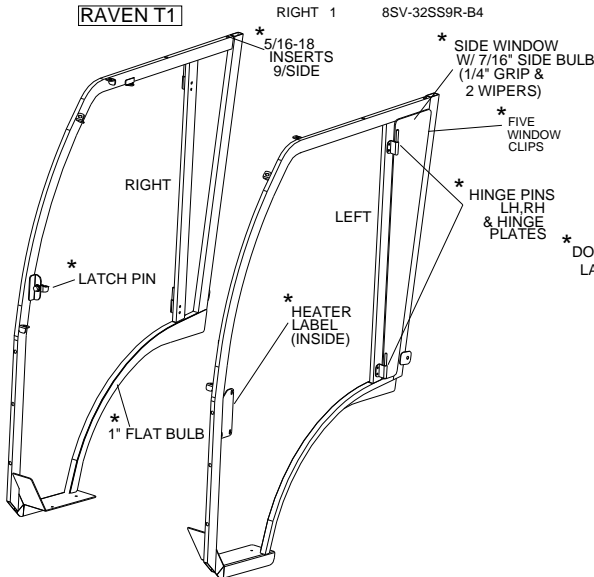

SOFT DOORS QTY. P/N
BLACK (WITH ORANGE VINYL) LEFT 1 8SV-32SS7L-O3
RIGHT 1 8SV-32SS7R-O3

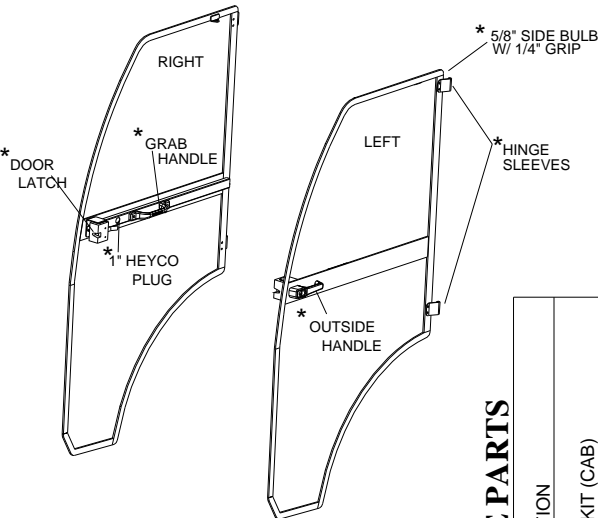

REAR CURTAIN QTY. P/N
1 8SV-KB2308-VK

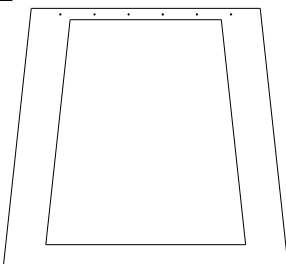

UNDER SEAT FILLER QTY. P/N
1 8SV-KB3310-VK

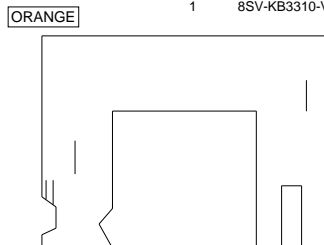

RUBBER TYPES:

5/8" SIDE BULB W/ 1/4" GRIP (15)	
9SV-PR23-15	
1/2" WEATHER SEAL (10')	
9SV-PR20-10	
TRIM LOK (10')	
9SV-PR01-10	
3/4" SIDE BULB W/ 1/4" GRIP & 2 WIPERS (15')	
9SV-PR38-15	
1" FLAT BULB	
9SV-PR05-10	
7/16" SIDE BULB W/ 1/4" GRIP & 2 WIPERS (15')	
9SV-PR29-15	
ARCH PSA (10')	
9SV-PR09-10	

ADDITIONAL SERVICE PARTS

QTY./UNIT	P/N	DESCRIPTION
1	KB33HWK-01	HARDWARE KIT (CAB)
1	9SV-DS02	CABLE DOOR STOP KIT
1	9SV-HDR1	DOOR HINGE KIT - LEFT AND RIGHT
1	9SV-IHRL	DOOR LATCH KIT - LEFT AND RIGHT
1	9DL01B	ROTARY DOOR LATCH - RH
1	9SV-GH	GRAB HANDLE KIT (2 HANDLES)
1	9SV-WL1	WINDSHIELD LATCH KIT (2 LATCHES)
1	9SV-HWS	WINDSHIELD HINGE KIT (2 HINGES)
1	8SV-PGB33CWL	COWL WINDOW

*IN HOUSE APPLICATIONS