



**DO NOT PROCEED WITH  
INSTALLATION UNTIL you have  
completed the steps below to  
**ACTIVATE THE AIR  
CONDITIONER WARRANTY****

**URGENT & CRITICAL DEALER / INSTALLER NOTE:**

*Congratulations on purchasing the latest and greatest air conditioning system for zero turn mowers! In order to supply adequate power to the air conditioning system, while not impeding any other mower functions, the system has been designed with a secondary dynamo, which operates on a common shaft with the factory supplied dynamo. It is critically important that the installation procedures in this manual be followed precisely.*

**REQUIRED STEPS TO ACTIVATE THE CAB AIR CONDITIONING WARRANTY:**

DUE TO THE CRITICAL NATURE OF THE INSTALLATION OF THE DYNAMO ASSEMBLY, IT IS EXTREMELY IMPORTANT FOR THE INSTALLER TO:

1. VIEW THE INSTRUCTIONAL VIDEO, (LINK BELOW) BEFORE BEGINNING THE DYNAMO INSTALLATION PROCESS.
2. CONTACT CURTIS AC TECH SUPPORT TO MAKE ARRANGEMENTS FOR A VIDEO CALL FOR DETAILED INSTALLATION INSTRUCTION AND SUPPORT, DURING THE DYNAMO INSTALLATION PROCESS.

**IF A VIDEO CALL CAN NOT BE MADE, A CLEAR PHOTO OF THE DOUBLE DYNAMO COMPLETED ASSEMBLY ON THE MACHINE MUST BE SENT IN TO CURTIS TECH SUPPORT FOR APPROVAL BEFORE STARTING THE ENGINE.**

THE PHOTO(S) MUST CLEARLY SHOW THE ALUMINUM SPACER BETWEEN THE TOP DYNAMO EARS AND THE 1/16" THICK SHIM ON THE RIGHT SIDE BETWEEN THE ENGINE DYNAMO MOUNTING BOSS AND THE SECONDARY (CURTIS) DYNAMO, AS WELL AS ALL INSTALLATION HARDWARE.

**FAILURE TO DO EITHER OF THESE THINGS WILL LIKELY CAUSE DYNAMO OR SHAFT DAMAGE AND WILL VOID THE WARRANTY.**

TO REQUEST A VIDEO APPOINTMENT, OR TO GET A PHOTO APPROVED, PLEASE CONTACT CURTIS AC TECH SUPPORT AT 508-459-4395, OR EMAIL [JSCHULLER@CURTISCAB.COM](mailto:JSCHULLER@CURTISCAB.COM)



**Scan the QR Code to the left for a 5 minute Dynamo installation video. (for MFG Codes below 1804733)**

<https://www.youtube.com/watch?v=eJrd9WvpcG8>

**PAY PARTICULAR ATTENTION to pages 6 - 8 regarding Dynamo and shaft installation.**

**PAY PARTICULAR ATTENTION to pages 20 and 21 regarding A/C Compressor Shroud Installation.**



**Kubota ZD1211**  
**(p/n: 1KUBZD1211PR)**  
 For cabs with MFG Codes below 1804733  
 Cab with A/C  
 (fits both 60" and 72" mowers.  
 Does not fit with bagger system)

*While this cab kit was designed to fit on the vehicle listed above, manufacturing tolerances and vehicle assembly may affect cab fitment. It is the responsibility of the cab installer to check all vehicle pedals and levers for full functionality and, as required, adjust the cab fitment to prevent any interference of the cab components with the travel of pedals or levers.*



Premium Cab Shown with Options

Available Options:

1. Side View Mirrors (P/N: 9PM5)
2. Switch Panel (P/N: 1KUBZD1211CK) (req'd for following 2 items)
3. Front LED Work Lights (P/N: 1KUBZD1211LK)
4. Front Wiper/Washer Kit (P/N: 1KUBZD1211WK)

Approximate Installation Time *
Experienced Dealer Technician – 4 Hours
Average Dealer Technician – 6 Hours
Do-It-Yourself – 6-8 Hours

Approximate Product Specifications
Floorboard to Roof Height: 60 inches
Weight: 240 lbs.
Cab Width: 54 inches

(\*=Not including accessories)

**Register** your new product quickly online at [Curtiscab.com/product-registration/](http://Curtiscab.com/product-registration/)



Curtis encourages all customers to register their Curtis products. However, failure to do so will not diminish right to warranty. Curtis Industries does not sell or share your information with anyone else.

**Download** a digital copy of your installation instructions online at [Curtiscab.com/literature/](http://Curtiscab.com/literature/)



Curtis strives to continuously improve our products, technical documentation, etc. Therefore, the installation manual for this product may have been updated after your product was packaged. The latest revision of the installation manual can always be found at the website above.

The contents of this envelope are the property of the owner. Leave with the owner when installation is complete.

## TABLE OF CONTENTS

WARNINGS, TIPS, & REQUIRED TOOLS.....	4
VEHICLE PREP.....	5
CAB INSTALLATION.....	6-22
CAB FEATURES & OPERATION.....	23
CARE AND MAINTENANCE.....	24
TROUBLESHOOTING.....	24
BELT ADJUSTMENT.....	25
DYNAMO SHAFT REPLACEMENT.....	26
SERVICE PARTS.....	27-32
BOLT TORQUE SPECIFICATIONS.....	33





## WARNINGS, TIPS, & REQUIRED TOOLS

Curtis cabs feature an assembly of parts designed for your vehicle which require adjustment and alignment of components to accommodate vehicle variations and provide proper weather protection. For accurate installation, proper operation, and years of satisfaction, please read and understand the installation and owner's manual fully prior to installing the cab.

From all of us at Curtis, we thank you for choosing our product.

	<h3>NOTICE</h3>
<p>Curtis Cabs, blades and general accessories add additional weight to the base vehicle. All Curtis accessory weights are listed in product brochures. Deduct the accessory's total weight from the vehicle's rated capacity and never exceed the vehicle's rated capacity including driver and passenger.</p>	

**▲ WARNING** Exposure to Carbon Monoxide can Cause illness, serious injury or death. Never operate vehicle if suspicious of Carbon Monoxide. Inspect exhaust system for leaks monthly. Leaks can result from loose connections, corrosion, cracks or other damage to the exhaust manifold. If leaks are found, repair or replace exhaust system. Do not use vehicle until repair or replacement is complete.

 <h2 style="margin: 0;">WARNING</h2>	
<h3 style="margin: 0;">S e r i o u s   I n j u r y   o r   D e a t h</h3>	
	<p>This cab enclosure does not provide protection from rollover or other accidents.</p>
	<p>This cab enclosure does not provide protection from flying objects including golf balls.</p>
	<p>This cab enclosure does not provide protection from lightning. When lightning threatens take cover and do not operate vehicle.</p>

**California Health and Safety Proposition 65 Warning:** This product may contain chemicals known to the state of California to cause cancer and birth defects or other reproductive harm.

## GENERAL INFORMATION BEFORE YOU START

### HELPFUL HINTS:

- Refer to parts diagram found in the service parts section of this manual to help identify parts during the assembly process.
- To assist with the cab installation, leave all fasteners loose for later adjustment unless otherwise specified.
- Read and understand all instructions before beginning.
- Apply a silicone sealant to seal any minor gaps that may occur due to vehicle variations.
- Use caution to avoid damaging the factory installed threaded inserts or weld nuts. Begin the thread engagement by hand to avoid or correct potential cross threading.
- Make sure the areas where the supplied self-adhesive hook Velcro will be applied are clean and dry and at room temperature for best adhesion.

### TOOLS REQUIRED:

- |  |  |
|--|--|
| <ul style="list-style-type: none"> <li>• Set of Standard and Metric Sockets (3/8" + 1/2" Drive)</li> <li>• 3/8" + 1/2" Drive Ratchets and Long Drive Extension</li> <li>• Set of Standard and Metric Open-End Wrenches</li> <li>• Set of Standard and Metric Allen Wrenches</li> <li>• #1, #2, and #3 Phillips Head Screwdrivers</li> <li>• Torque Wrench (1/2" Drive)</li> <li>• Rubber Mallet or Plastic Dead Blow Hammer</li> <li>• Bungee Cord or Twine</li> <li>• Hoisting Strap</li> </ul> | <ul style="list-style-type: none"> <li>• Drill/Driver</li> <li>• 9/32" Drill Bit</li> <li>• #2 and #3 Phillips Head Bit</li> <li>• Utility Knife</li> <li>• Pair of Scissors</li> <li>• Shears</li> <li>• Grease</li> <li>• Black Silicone Sealant</li> <li>• Steel Straight Edge</li> </ul> |
|--|--|

# CAB INSTALLATION

## Step 1: (Vehicle Prep)

- 1.1 Park vehicle in a location accessible by an overhead hoist.
- 1.2 Disconnect the negative battery terminal.
- 1.3 See fig. 1.3. Remove the bolt from the battery clamp and replace with a longer one from the supplied hardware kit and re-use the nut, but do not re-connect the battery.

<u>Hardware Used</u>	<u>Qty</u>
5/16x1-1/4 Square Head Bolt	1

- 1.4 See fig. 1.4. Remove the plastic cover around both the left and right control sticks. Note: The nut on the lower screw can be loosened slightly and the panel can then be removed. It does not need to be fully removed from the screw.
- 1.5 See fig. 1.5. Install the supplied bulb rubber to the bottom flange of the covers. The rubber should be joined where shown.
- 1.6 Re-install only the left plastic cover ensuring that the bulb on the rubber is not causing interference with the controls or switch. The right cover will be re-installed in a later step.
- 1.7 See fig. 1.7. Disconnect the wires from the stud on the starter as well as the wire plugged into the connector on the starter.
- 1.8 Remove and discard three bolts from the left side of the engine as shown in fig. 1.7.

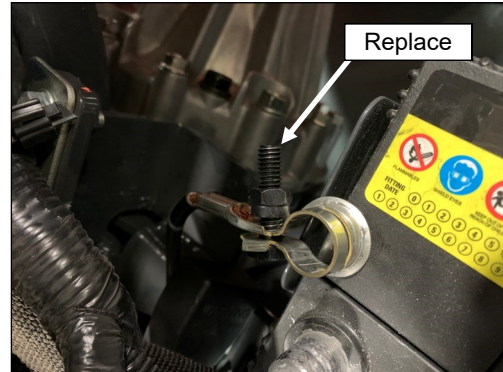

Fig. 1.3 (Replace Negative Battery Bolt)

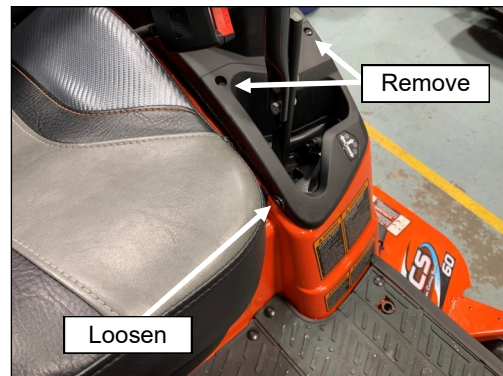

Fig. 1.4 (Remove Covers)



Fig. 1.5 (Install Rubber (Left shown))

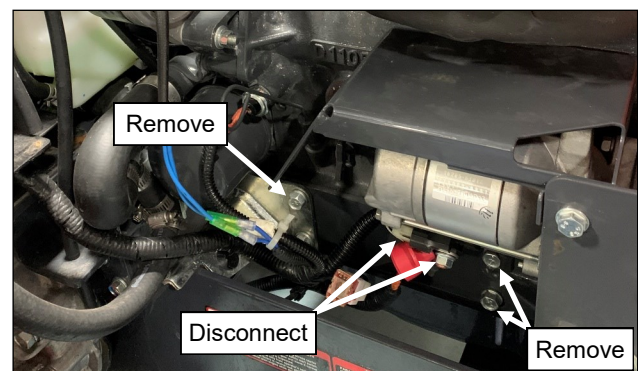

Fig. 1.7 (Remove Components)

**Step 2: (Dynamo Installation)**

- 2.1 See figures 2.1a and b. Remove the OEM dynamo from the vehicle then remove and discard the OEM shaft, flat washer, lock washer, and hex nut. A new shaft and hardware is supplied. Save the OEM dynamo, rotor washer, rotor cap, and washer.
- 2.2 See fig. 2.2. Using the Curtis dynamo with the factory installed Curtis shaft, install the OEM dynamo onto the shaft. Then install the convex rotor washer with the curved side against the bearing. Then install the rotor cap and then the washer. Install the M12 flat washer, then the split lock washer, then the nut (loosely).

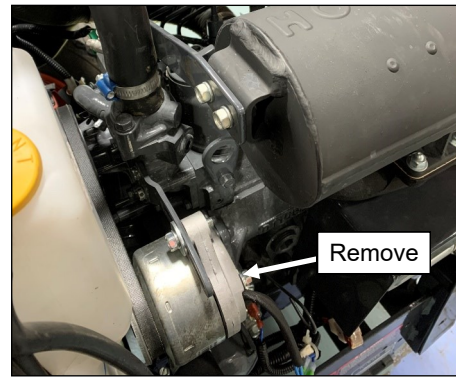

Fig. 2.1a (Remove Dynamo)

<u>Hardware Used</u>	<u>Qty</u>
M12x24 Steel Flat Washer	1
M10x18 Split Lock Washer	1
M10x1.25 Nut	1

- 2.3 Suggestion: Hold a 5/8" open-end wrench sideways in a bench vise for this step. Per fig. 2.3, orient the dynamo assembly vertically so the OEM dynamo is on top. Place the dynamo assembly into the open end of the wrench so the flats on the shaft fit properly. Ensure that the flat washer is centered on the shoulder of the shaft when tightening. Torque the M10 hex nut to 28.9 - 32.5 ft-lbs. (39.2 - 44.1 Nm) on the OEM dynamo.

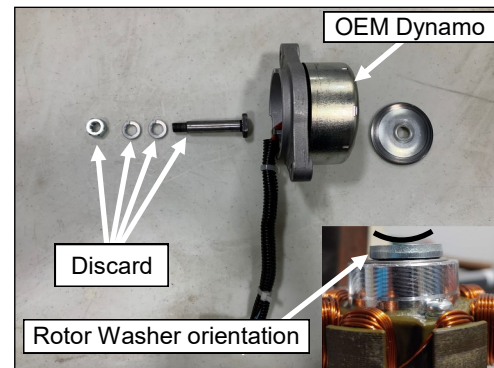

Fig. 2.1b (Discard 4 OEM components)

- 2.4 See fig. 2.4. Flip the dynamo assembly over so that the Curtis dynamo is now on top. Loosen, the hex nut on the Curtis dynamo so it's flush with the end of the shaft (do not remove hex nut). CAUTION: This is a left-hand threaded nut.

- 2.5 See fig. 2.5. Orient the dynamos so that the clearance mounting hole in the Curtis dynamo lines up with the threaded hole in the OEM dynamo. Install an M8 steel flat washer onto the 80mm long bolt and pass this thru the clearance ear of the Curtis dynamo, then thru the .062" thick Shim Washer, then thru the 3/4" O.D. Spacer, then thread the bolt into the threaded ear of the OEM dynamo. Do not allow the screw to protrude out the back side of the OEM ear.

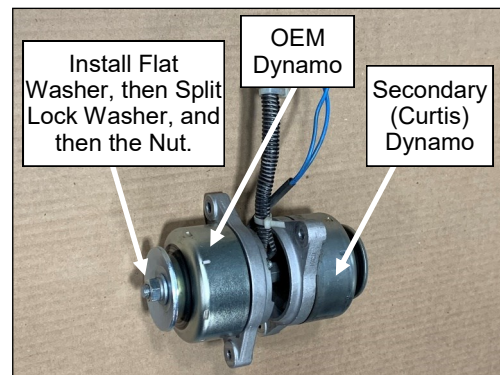

Fig. 2.2 (Install OEM Dynamo onto shaft)

<u>Hardware Used</u>	<u>Qty</u>
Spacer 3/4" OD x 1.083" long	1
M8x1.25x80mm Hex Head Bolt	1
M8x16 Flat Washer	1
Shim Washer, 13/16" x 11/32" x .062" thick	1

1.083" lg. Spacer **and** .062" thick Shim Washer. Combined length of both pieces to be 1.145" long.

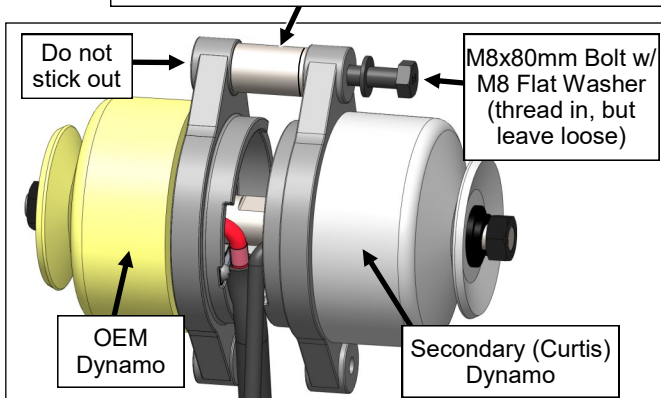

Fig. 2.5 (Install Spacer)

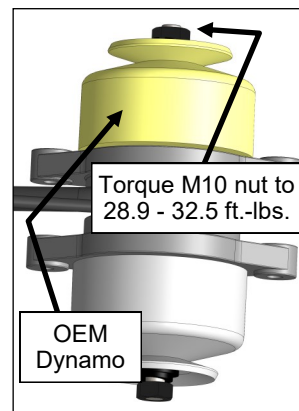

Fig. 2.3

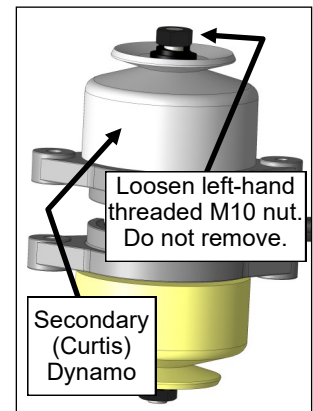

Fig. 2.4

## CAB INSTALLATION

- 2.6 See fig. 2.6. Install the dynamo assembly onto the vehicle engine's lower dynamo mounting boss. Orient so that the OEM dynamo is towards the front of the vehicle. Install the split lock washer, then the flat washer onto the 65mm long bolt, then pass the bolt through the clearance hole in the OEM dynamo mounting ear, through the engine boss, through the .062" thick shim (this shim needs to be on the rear side of the mounting boss), and thread into the tapped hole in the Curtis dynamo ear. Leave loose at this time.

<u>Hardware Used</u>	<u>Qty</u>
M8x1.25x65mm Hex Head Bolt	1
M8x16 Flat Washer	1
M8x14 Split Lock Washer	1
13/16"x11/32"x.062" Thick Shim	1

- 2.7 See fig. 2.7. Tighten the left-hand threaded hex nut on the Curtis Dynamo. Ensure that the flat washer is centered on the shoulder of the shaft when tightening. Use a 5/8" open-end wrench on the center of the shaft where the flats are provided. Torque this left-hand threaded hex nut to 28.9 - 32.5 ft.-lbs. (39.2 - 44.1 Nm).

- 2.8 See fig. 2.8. With a 13mm wrench, tighten the upper bolt (80mm long) so that the threads protrude thru the OEM dynamo ear and into the adjustment slot on the vehicle's tensioning bracket. Keeping the wrench on the head of the bolt, install an M8 flanged locknut and tighten until snug, but loose enough that pivoting adjustment is still available. **NOTE: When threading the locknut onto the bolt, you must use a wrench on the head of the bolt to prevent it from unthreading from the OEM dynamo ear.**

<u>Hardware Used</u>	<u>Qty</u>
M8x1.25 Flange Locknut	1

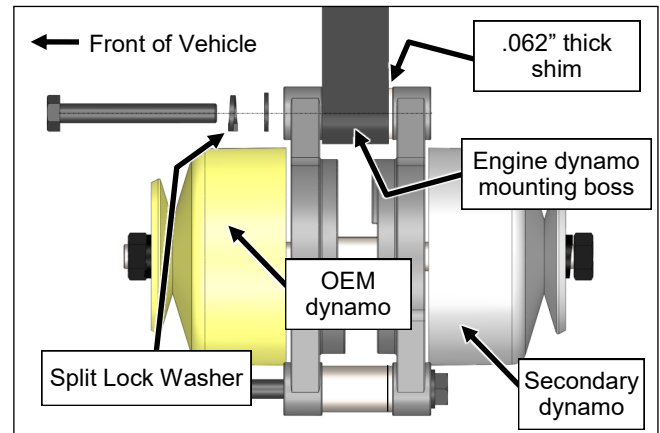

Fig. 2.6 (Install Double Dynamo onto Engine)

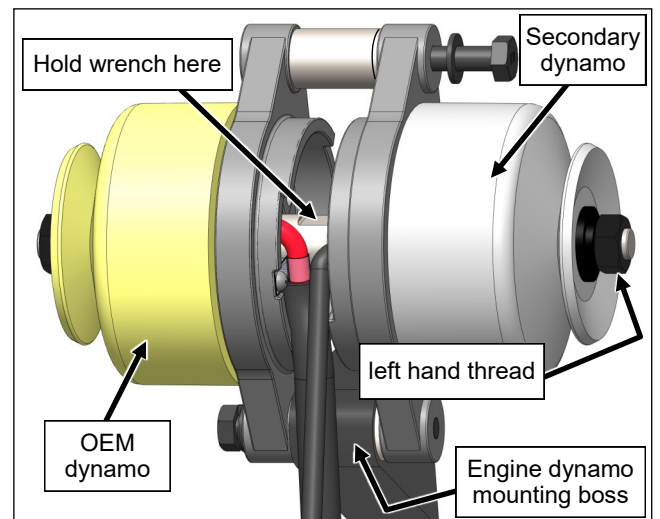

Fig. 2.7 (Torque Secondary Dynamo Nut)

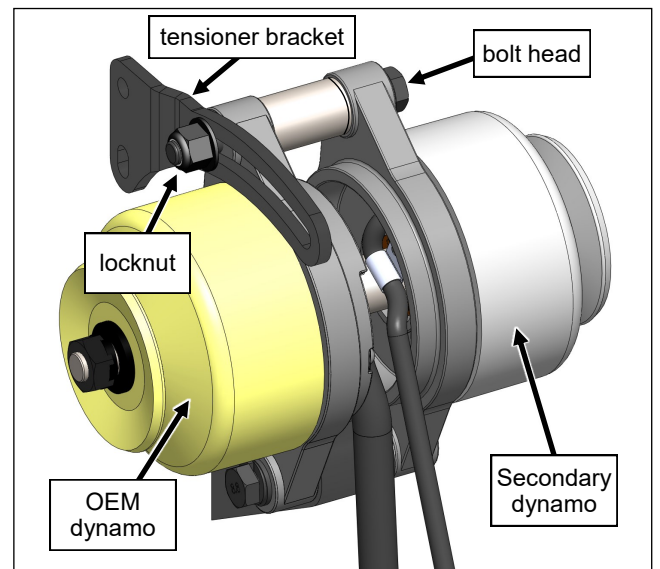

Fig. 2.8 (Engage the tensioner bracket)

## CAB INSTALLATION

2.9 Verify all components are in correct positions per the fig. 2.9 exploded view below. Re-install the OEM belt onto the dynamo and tension to OEM specifications. **NOTE: When fully tightening the M8 flanged locknut, you must use a wrench on the head of the bolt to prevent it from unthreading from the OEM dynamo mounting ear.** Tighten the flanged nut on the top bolt at this time. Tighten the lower pivot bolt last.

**NOTICE:** The design intent is that the two dynamos are parallel to each other. If they are not parallel, the shaft will see high forces and may break. As shown below, the width of the engine dynamo mounting boss plus a 1/16" thick shim washer equals 1.145".

If your cab has an MFG CODE prior to 1804733, the spacer provided in your kit may be steel and only 1.083" long. Therefore, after verifying the length of the spacer, you may need to add an additional 1/16" thick shim washer between the steel spacer and the Curtis dynamo.

Prior to starting the engine, measure the distance between the ears on the dynamos at the top and bottom to confirm that the two measurements are 1.145".

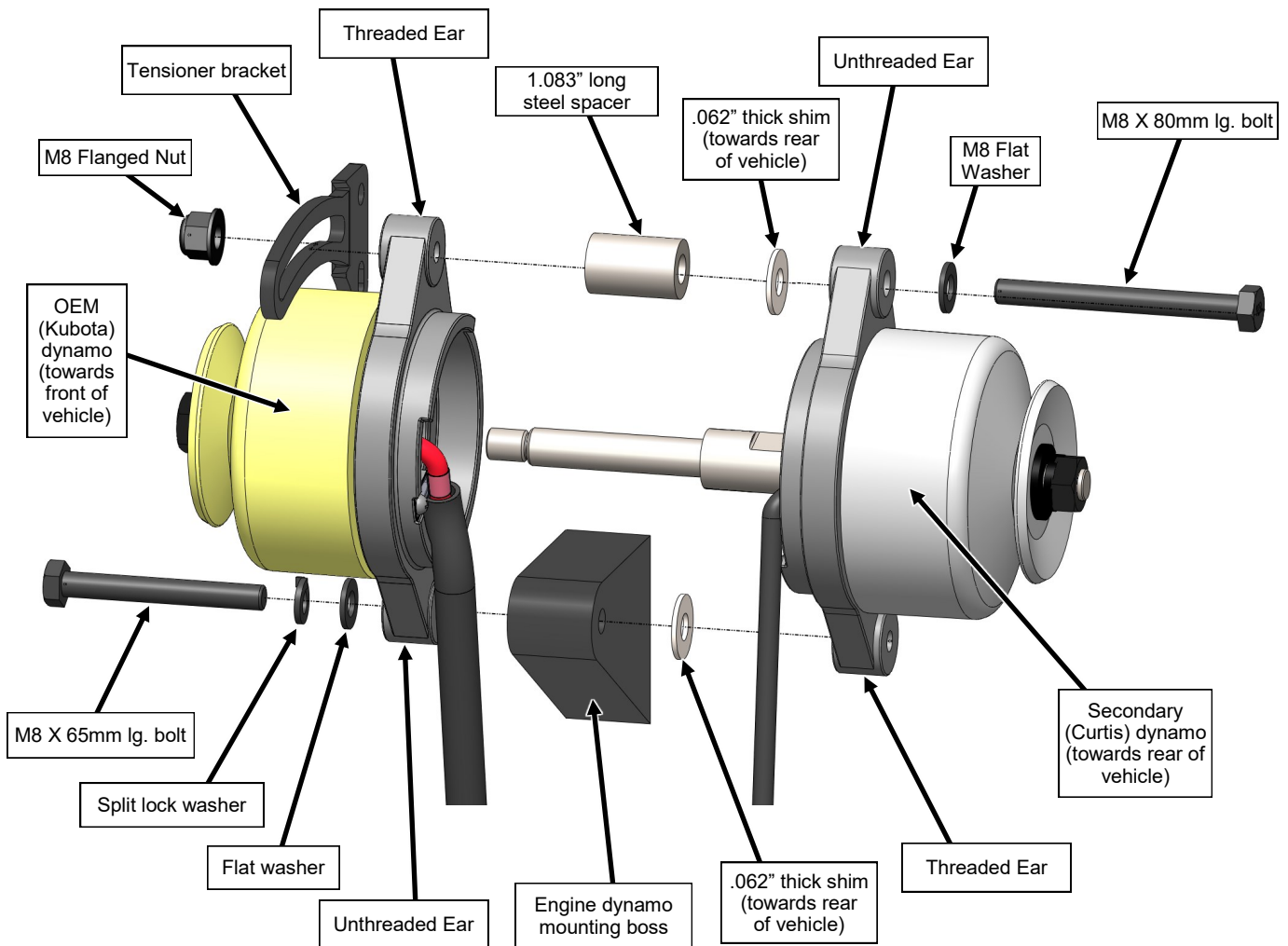

Fig. 2.9 (Double Dynamo Exploded View)



# CAB INSTALLATION

## Step 2: (Dynamo Installation)

- 2.1 Remove and save the OEM dynamo. Discard the mounting hardware.
- 2.2 Remove and discard the nut and washers from the OEM dynamo shaft.
- 2.3 Remove and discard the shaft from the OEM dynamo, but keep the dynamo together when removing to ensure spacer stays in its proper location. If the rotor is separated from the stator and the spacer comes loose, re-install with the smooth convex side of spacer inwards against the bearing.
- 2.4 Install the OEM dynamo onto the shaft of the secondary dynamo provided in the kit. A rubber or plastic mallet may be required to tap the shaft through the bearings. Secure with the following hardware and torque to 28.9 - 32.5 Ft-Lbs. (39.2 - 44.1 Nm). Ensure that the flat washer is centered on the shoulder of the shaft when tightening.

<u>Hardware Used</u>	<u>Qty</u>
M12x24 Steel Flat Washer	1
M10x18 Split Lock Washer	1
M10x1.25 Nut	1

- 2.5 Holding a 5/8" wrench on the flats in the center of the shaft, loosen the left-hand threaded nut on the secondary dynamo until the face of the nut is flush with the end of the shaft. Do not remove the nut.
- 2.6 Position the supplied  $\text{\O}3/4\text{"OD} \times 1.145\text{"}$  long spacer between the top dynamo ears. Pass the bolt through the clearance hole of the secondary dynamo, through the spacer, and thread into the OEM dynamo ear. Leave loose and don't allow the screw to stick out the other side of the OEM dynamo ear.

## Step 3: (Install ROPS Mounts)

- 3.1 See fig. 3.1. Remove the left and right hand tension screws and clips on the ROPS and discard.
- 3.2 Remove the ROPS pin and bolt from the left side and discard. Leave the right side installed at this time.
- 3.3 See fig. 3.3. Remove the upper bolt on the cross hose protector as shown and discard.
- 3.4 See fig. 3.4. Install the left ROPS mount using the following hardware. The large bolt in the pivot hole should be tightened just enough so that the ROPS can still tilt without damaging the paint. The large bolt in the hole where the pin was

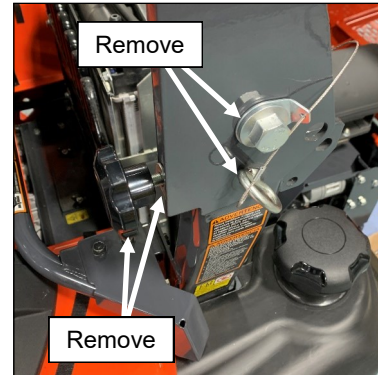

Fig. 3.1 (Remove hand screws and ROPS Bolt)



Fig. 3.3 (Remove upper bolt)

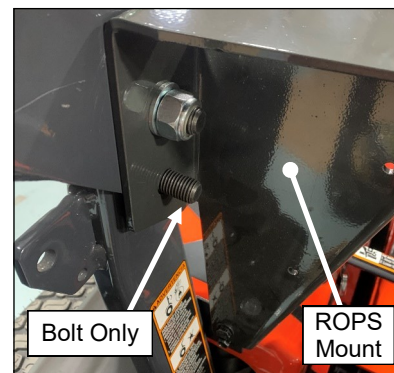

Fig. 3.4 (Install Left ROPS Mount)



Fig. 3.6 (Tilt the ROPS)

# CAB INSTALLATION

removed should be installed through the bracket, but no nut installed at this time. Tighten the smaller M8 bolt at this time.

<u>Hardware Used</u>	<u>Qty</u>
M16x2x80mm Hex Head Bolt	2
M16x30 Steel Flat Washer	3
M16x2 Locknut	1
M8x1.25x30mm Flange Bolt	1

- 3.5 Repeat steps 3.2, 3.3, and 3.4 for the right side.
- 3.6 See fig. 3.6. Remove the lower M16 bolts from the previous steps and tilt the ROPS back and re-use the bolts to pin in the tilted position. Be careful not to damage the engine hood if it is in the open position. The nuts on the lower bolts will be installed in a later step.

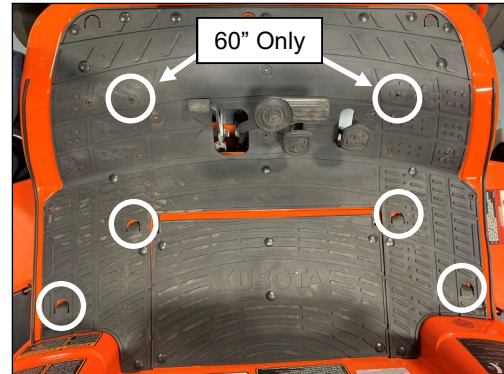

Fig. 4.1 (Remove Bolts)

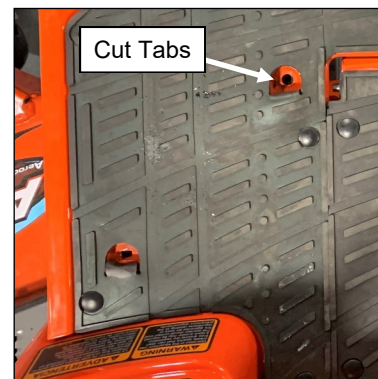

Fig. 4.2 (Cut Floormat)

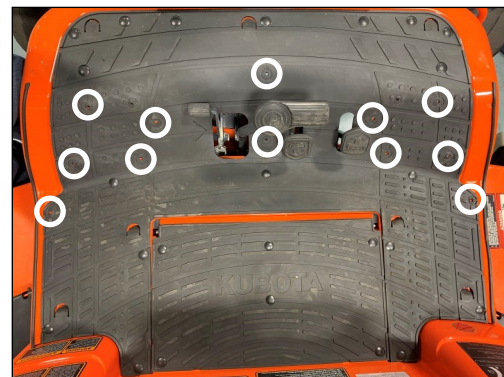

Fig. 4.3 (Remove Pine Tree Clips)

## Step 4: (Vehicle Prep)

- 4.1 Remove and discard the four floorboard bolts shown in Figure 4.1. If the mower is a 60", remove two additional bolts in the location shown.
- 4.2 See fig. 4.2. Cut the rubber tabs on the floormat at the bolt locations as shown so that the hole is clearly accessible.
- 4.3 See fig. 4.3. Remove the pine tree clips from the floormat at the 12 locations shown.
- 4.4 If installing on a 60" mower, remove and save the tilting front cover at the front of the machine.
- 4.5 See fig. 4.5. Install the pedal seal panel on top of the floormat as shown. Secure to the floorpan

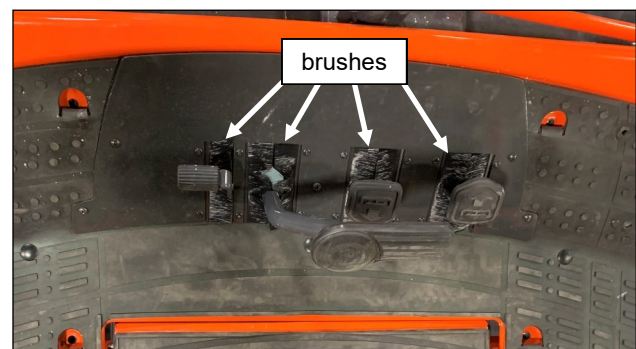

Fig. 4.5 (Install Sealing Brushes)

# CAB INSTALLATION

using the following hardware. The floorpan may need to be lifted slightly in the front on a 60" mower to access the center screw.

<u>Hardware Used</u>	<u>Qty</u>
#10-32x3/4" Phillips Head Screw	6
#10-32 Flange Nut	6

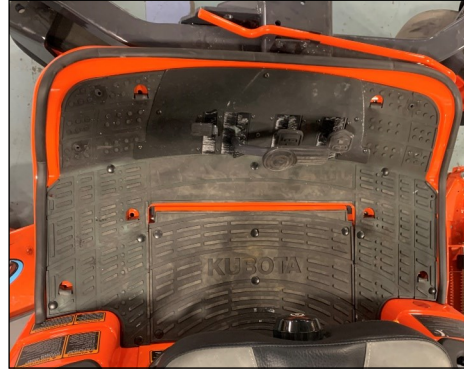

Fig. 4.6a (Seal location on 60")



Fig. 4.6b (Seal location on 72")

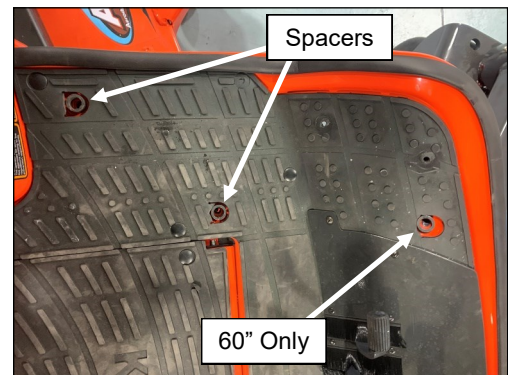

Fig. 4.7 (Install Spacers)

- 4.6 Install self-adhesive seal around the edge of the floorpan as shown and cut to length. Refer to Figure 4.6a for 60" and 4.6b for 72".

Note: placement on the 72" machine. Seal should follow along the white line shown in fig. 4.6b.

- 4.7 See fig. 4.7. Insert spacer bushings into the depressions where the floorboard bolts were removed. (72" uses 4 spacers, 60" uses 6 spacers)

<u>Hardware Used</u>	<u>Qty</u>
1/2" Long Spacer	4 or 6

- 4.8 Remove and discard the two screws securing the voltage regulator to the frame.

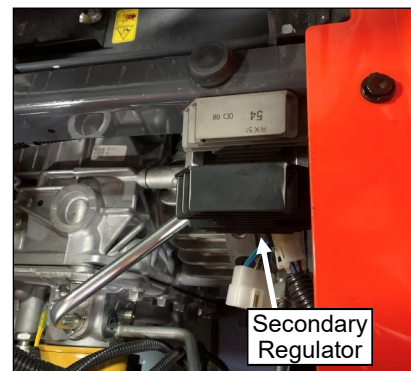

Fig. 4.9 (Install Secondary Regulator)

# CAB INSTALLATION

- 4.9 See fig. 4.9. Install the supplied secondary voltage regulator in front of the OEM regulator with the following hardware.

<b>Hardware Used</b>	<b>Qty</b>
M6x1.0x70mm Hex Head Bolt	2
M6x12 Steel Flat Washer	2
1.25" Long Aluminum Spacer	2

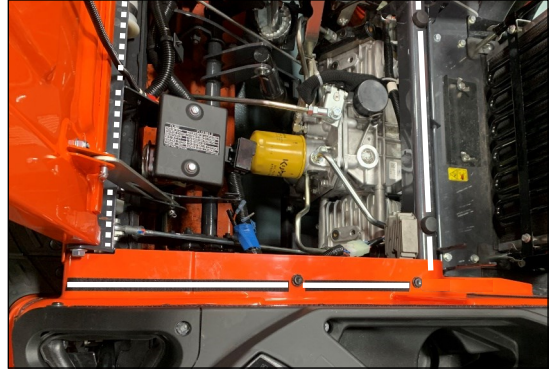

Fig. 4.10 (Install Velcro)



Fig. 5.1 (Move Seat forward, Rotate seatback)



Fig. 5.3 (Unbolt Compressor)

- 4.10 See fig. 4.10. Flip the seat forward and install the supplied adhesive Velcro as shown. Be sure to wipe down the surfaces where the Velcro will be adhered and that the surfaces are at room temperature.

Apply between round seat bumpers  
 Apply along horizontal edge of fenders  
 Apply 3 sections underneath front seat support frame member as indicated by dotted line. Velcro must be on the underside.

## Step 5: (Cabin Installation)

- 5.1 See fig. 5.1. Lower the seat and slide the seat all the way forward and use the knob on the seat to tilt the seatback forward as much as possible.



Fig. 5.4 (Position lifting strap)

## CAB INSTALLATION

- 5.2 Remove the doors from the cabin and set aside carefully to prevent scratching the panels.
- 5.3 See fig. 5.3. Remove the 3 bolts securing the compressor bracket to the base of the shipping mount and cut any zip ties holding the hoses and wire harness to the shipping mount. Support the compressor using a bungee cord or rope. Do not ever use the hoses to support the compressor or damage may occur.
- 5.4 See fig. 5.4. Position a lifting strap where shown so that it sits roughly 2" in front of the b-pillar.

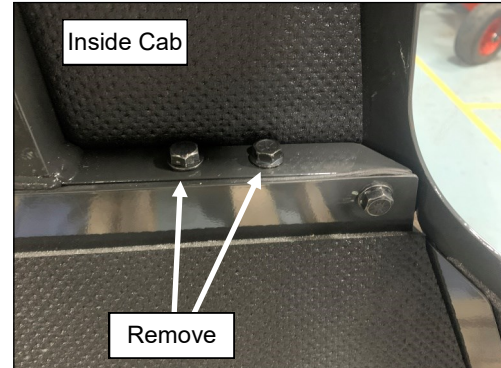

Fig. 5.5a (Remove Rear Bolts)



Fig. 5.5b (Remove Lag Screws)

- 5.5 See figures 5.5a and b. Put tension on the lifting strap with the overhead hoist. Remove and discard the 4 bolts holding the rear of the cab down to the shipping bracket (located inside the cab) as well as the 4 lag screws holding the floorboards to the pallet.

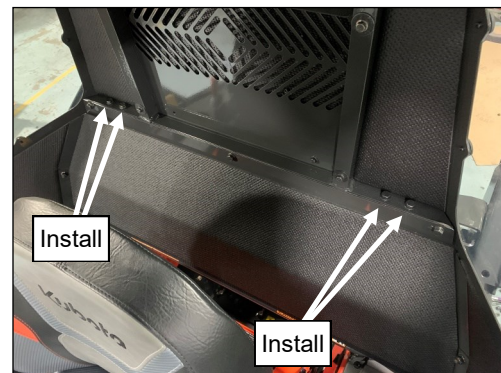

Fig. 5.8 (Install Rear Bolts)

- 5.6 With assistance, lift the cabin and position over the vehicle. Be sure to support the A/C compressor so that it never hangs from the hoses.
- 5.7 Lower the cabin slowly onto the vehicle being careful to not scratch the fenders with the rear edge of the floorboard. The A/C compressor should pass to the inside of the ROPS and end up on the left side of the engine.

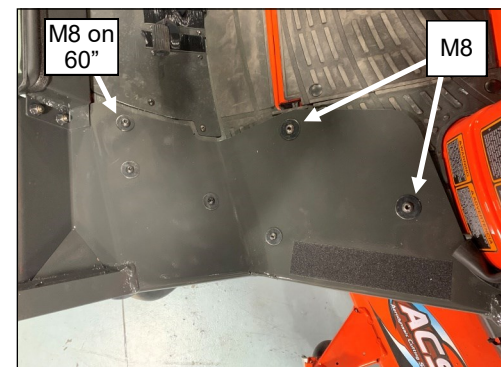

Fig. 5.9 (Install Floorboard Bolts)

- 5.8 See fig. 5.8. Fasten the rear of the cabin to the

# CAB INSTALLATION

ROPS mounts using the following hardware.  
Leave loose at this time.

<u>Hardware Used</u>	<u>Qty</u>
5/16-18 x 1-3/4 Hex Head Bolt	4
5/16-18 Flange Nut	4

- 5.9 See fig. 5.9. Fasten the cab to the floor of the tractor using the following hardware. Note: On 60" tractors, use 6 M8 bolts. On 72" tractors, only install 4 M8 bolts and leave additional slot open.

<u>Hardware Used</u>	<u>Qty</u>
M8x1.25x40mm Button Head Bolt	4 or 6
5/16x1-1/4" Steel Fender Washers	4 or 6
1/4-20x1" Button Head Bolt	6
1/4x1" Steel Fender Washers	6
1/4-20 Flange Nut	6

- 5.10 Tighten all floorboard bolts and rear cabin bolts at this time  
5.11 Raise ROPS bar and loosely re-install M16 bolts used to pin it.

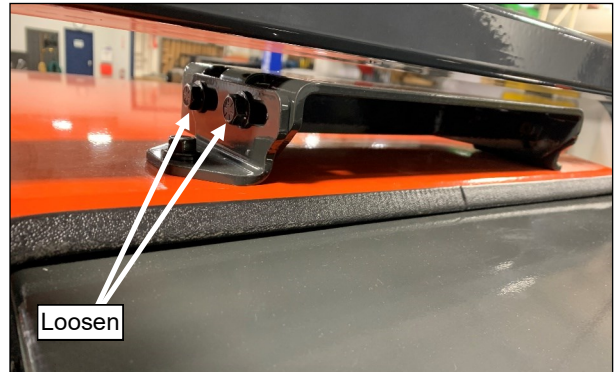

Fig. 5.12 (Loosen Upper ROPS Mount)

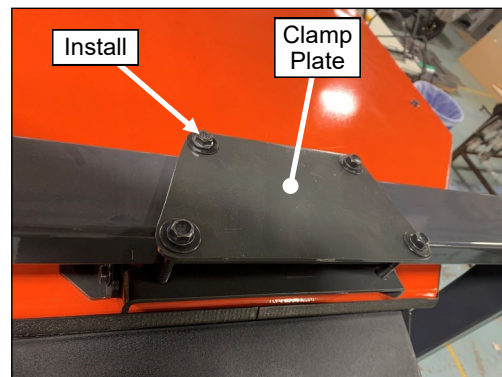

Fig. 5.13 (Install Upper ROPS Clamp Plate)

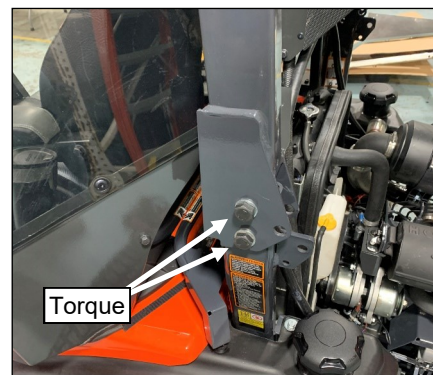

Fig. 5.15 (Tighten ROPS Bolts)

- 5.12 See fig. 5.12. Loosen the 4 factory installed 5/16" bolts securing the upper ROPS mount so that the mount can slide up against the underside of the ROPS.

- 5.13 See fig. 5.13. Install the upper ROPS clamp plate to the top side of the ROPS and secure with the following hardware. Bolts can be tightened at this time. Hand tighten only. Do not over-tighten or plate will deform.

<u>Hardware Used</u>	<u>Qty</u>
5/16-18x2-1/2" Flange Bolts	4
5/16x1" Steel Fender Washers	8
5/16-18 Flange Nut	4

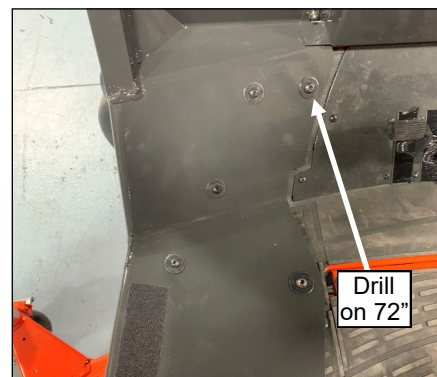

Fig. 5.16 (Drill Hole on 72" Mowers)

# CAB INSTALLATION

5.14 Re-tighten the bolts loosened in step 5.12.

5.15 See fig. 5.15. Install the washer and nuts onto the M16 ROPS bolts and tighten at this time. Note: The tightening torque is different for the upper and lower bolt.

Torque the upper bolt to 167 to 196 Nm (123 to 144 lbf-ft)

Torque the lower bolt to 78 to 90 Nm (58 to 66 lbf-ft)

<u>Hardware Used</u>	<u>Qty</u>
M16x30 Steel Flat Washer	1
M16x2 Locknut	1

5.16 See fig. 5.16. If installed on a 72" mower, drill 9/32" holes through the tractor floorboard centered on the open slots in the cab floorboards. Do not drill too deep to avoid damaging any items on the underside of the floorboard.

5.17 Dab the raw edge of the holes in the steel floorboard with some paint to prevent corrosion.

5.18 Install the following hardware into the newly drilled holes and tighten.

<u>Hardware Used</u>	<u>Qty</u>
1/4-20x1" Button Head Bolt	2
1/4x1" Steel Fender Washers	2
1/4-20 Flange Nut	2

## Step 6: (Compressor Installation)

6.1 Loosen the lower and upper pivot bolts that are securing the compressor to its mounts.

6.2 Move compressor into location on the left side of the engine and secure the bracket with the hardware listed below as shown in figures 6.2a and b.

<u>Hardware Used</u>	<u>Qty</u>
M10x1.25x30mm Flange Bolt	3

6.3 Align the pulley on the compressor with the pulley on the dynamo using a steel straight edge and tighten the three mounting bolts installed in steps 6.2a and b.

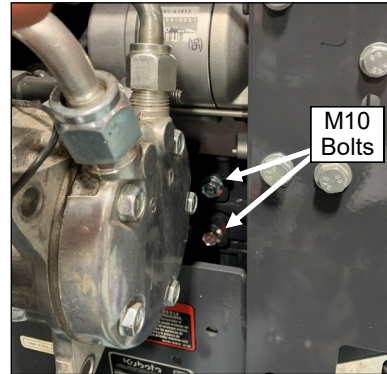

Fig. 6.2a (Secure Compressor with 2 Bolts in Rear)

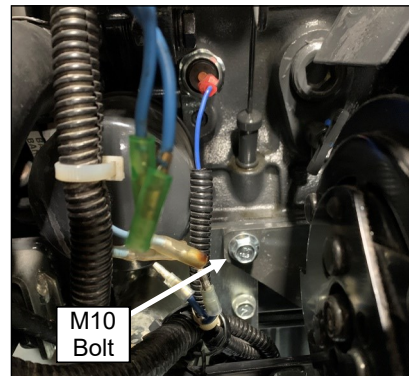

Fig. 6.2b (Secure Compressor with 1 Bolt in Front)

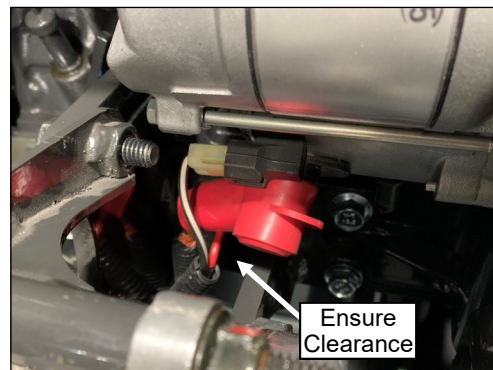

Fig. 6.4 (Re-Attach Starter Wires)

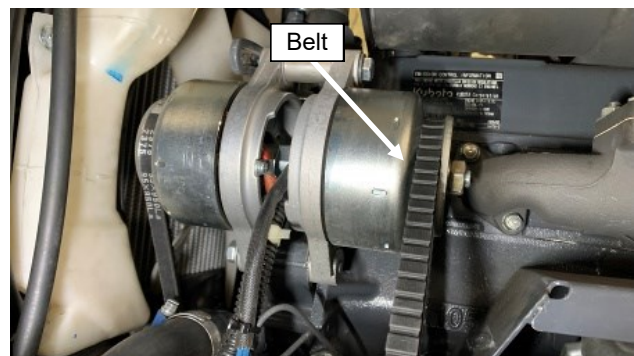

Fig. 6.5 (Install Belt and Tension)

# CAB INSTALLATION

- 6.4 See fig. 6.4. With the compressor tilted all the way out in its adjustment slot, re-connect the two ring terminals to the stud on the starter and re-install the additional wire into the connector on the starter. Torque the stud to 5.9 to 11.8 Nm (4.3 to 8.7 lbf-ft)

Note: Be sure that none of the wires or terminals are touching the steel compressor bracket after tightening the starter nut! Ensure protective boot is re-installed.

- 6.5 See fig. 6.5. Install the supplied belt and tension. Tighten all compressor pivot bolts at this time.

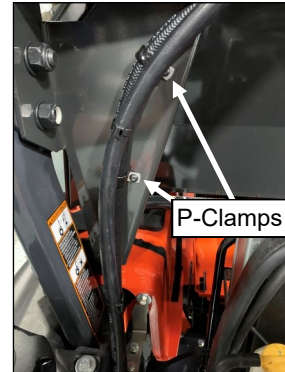

Fig. 6.6 (P-Clamp Hoses to ROPS Bracket)

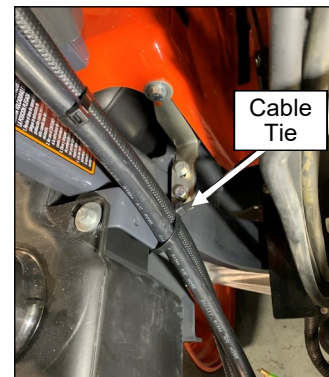

Fig. 6.7 (Cable Tie Hoses)

- 6.6 See fig. 6.6. Install two p-clamps to the lower ROPS brackets as shown to secure the larger A/C hose to the ROPS bracket. Twist clamps and adjust hose position so that hose does not contact sharp edges of ROPS bracket.

<u>Hardware Used</u>	<u>Qty</u>
1/4-20x1" Button Head Bolt	2
1/4-20 Flange Nut	2
3/4" P-Clamp	2

- 6.7 See fig. 6.7. Secure both hoses to the vehicle frame using a cable tie as shown. Ensure that the hoses will not contact any sharp edges.

<u>Hardware Used</u>	<u>Qty</u>
Cable Tie	1

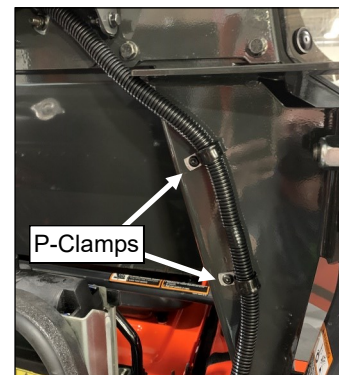

Fig. 7.1 (P-Clamp Wire Harness to ROPS Bracket)

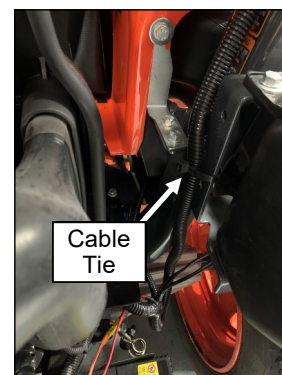

Fig. 7.2 (Secure Wire Harness to Vehicle)



# CAB INSTALLATION

## Step 7: (Wiring)

7.1 See fig. 7.1. Cut the cable ties securing the wiring harness and attach the harness to the lower ROPS brackets with p-clamps as shown.

<u>Hardware Used</u>	<u>Qty</u>
1/4-20x1" Button Head Bolt	2
1/4-20 Flange Nut	2
3/4" P-Clamp	2

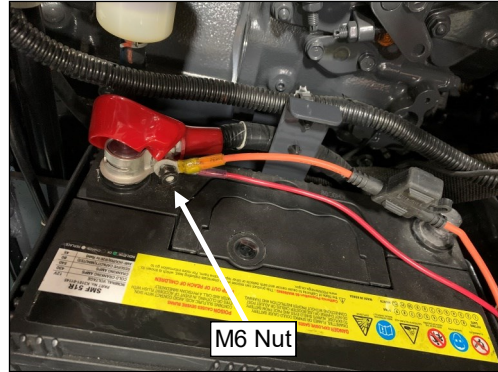

Fig. 7.3 (Attach Red Wires to Battery)

7.2 See fig. 7.2. Secure the wire harness to the vehicle frame using a cable tie as shown. Ensure that the harness will not contact any sharp edges.

<u>Hardware Used</u>	<u>Qty</u>
Cable Tie	1



Fig. 7.4 (Route Harness to Right Control Sick)

7.3 See fig. 7.3. Install the ring terminals on the red wires onto the stud on the positive battery clamp (outboard of the existing battery clamp nut) and secure with the following hardware.

<u>Hardware Used</u>	<u>Qty</u>
M6x1.0 Nut	1



Fig. 7.5 (Connect Wires to Switch)

7.4 See fig. 7.4. Locate the portion of the wire harness with two ring terminals crimped on the ends of black and gray wires. Route the ring terminals forward over the ROPS tube in front of the battery next to the existing wiring and up along the right side of the vehicle to right hand control.

Note: Wires must be routed above the ROPS, but below the flat area that the hood seals on when it

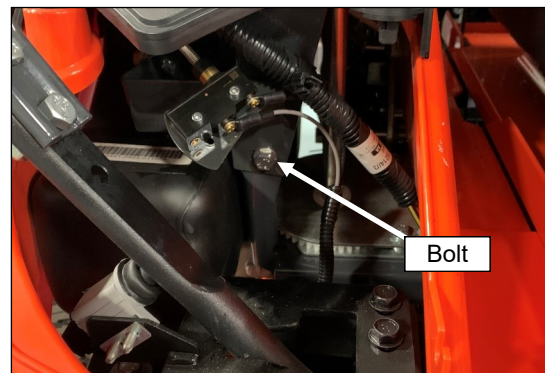

Fig. 7.6 (Install Switch Bracket)

## CAB INSTALLATION

is closed.

Avoid any moving parts.

- 7.5 See fig. 7.5. Route the wires up behind the right control stick and connect to the supplied switch as shown. The gray wire should go to the center screw (NO, #3) and the black wire should be connected to the COM, #1 screw.

It is recommended to do the assembly over the floor of the tractor to prevent losing any screws.



Fig. 7.7 (Re-Install Cover)

- 7.6 Remove the bolt shown in figure 7.6 and re-install with the switch bracket so that the spring loaded switch rod will be contacted by the throttle control lever. Adjust the bracket and switch so that when the throttle control lever is beyond 3/4 throttle the switch is engaged. The switch can be rotated on the bracket and the bracket can also be rotated where it mounts to the vehicle.



Fig. 7.8 (Route Wiring)

- 7.7 See fig. 7.7. If installing the optional seal kit, do so at this time. Otherwise, re-install the plastic cover (removed in step 1.4 on page 5) over the right hand control stick.



Fig. 7.9 (Connect Regulator)

- 7.8 See fig. 7.8. Route the remaining section of the harness with the white connector on the end forward from the battery area over the ROPS and up under the seat. The harness should run across the top of the transmission along the existing OEM harness and end on the left side of the vehicle.

Note: Wires must be routed above the ROPS, but below the flat area that the hood seals on when it is closed.

- 7.9 See fig. 7.9. Connect the white connector on the harness to the mating connector on the secondary

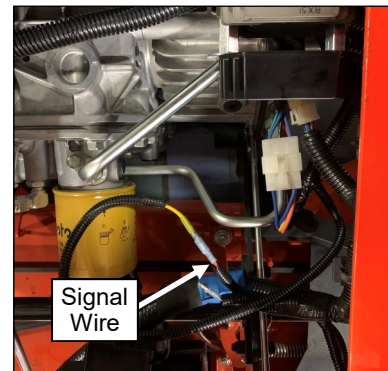

Fig. 7.10 (Locate OEM Signal Wire)

## CAB INSTALLATION

regulator.

- 7.10 See fig. 7.10. Cut the blue tape on the OEM vehicle wire harness under the seat to expose a male and female bullet terminal. Connect the male bullet terminal at the end of the yellow wire on the A/C wire harness to the female bullet terminal on the OEM harness.



Fig. 7.12 (Connect Dynamo Wiring)

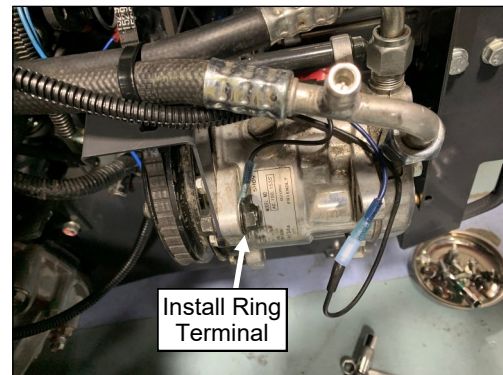

Fig. 7.13 (Connect Dynamo Wiring)

- 7.11 Route the two remaining sections of wires on the A/C harness out the rear of the left side of the vehicle so that they pass above the ROPS tube and end near the compressor.

- 7.12 See fig. 7.12. Re-connect the OEM dynamo wires to the vehicle wire harness. Connect the blue wires with the two bullet terminals from the A/C harness to the bullet terminals on the secondary dynamo.

- 7.13 See fig. 7.13. Connect the female bullet terminal on the end of the blue wire to the male bullet terminal on the compressor.

- 7.14 Remove the bolt shown in figure 7.13 and install the 3/8" ring terminal from the A/C harness onto the bolt so that it is contacting the ear of the



Fig. 7.17 (Connect Ground Wires)

# CAB INSTALLATION

compressor.

- 7.15 Use cable ties to secure the wire harness going to the compressor to the hoses.
- 7.16 Re-install the negative terminal back onto the battery post and tighten.
- 7.17 See fig. 7.17. Install the 4 ring terminals on the black ground wires to the battery bolt and secure with an additional nut.

**Hardware Used**  
5/16-18 Serrated Nut

**Qty**  
1

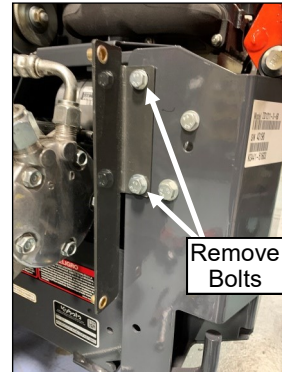

Fig. 9.1 (Install Rear Shroud Bracket)



Fig. 9.2 (Install Front Shroud Bracket)

## Step 8: (Functionality Testing)

- 8.1 Ensure that all wires and hoses are securely fastened with cable ties to prevent any rubbing or chaffing on sharp or hot objects.
- 8.2 Turn the vehicle on and check to make sure that belts and components are not vibrating excessively.
- 8.3 Bring engine to full throttle, turn on A/C blower, and move thermostat to cold.
- 8.4 Check to make sure A/C is blowing cold air.
- 8.5 Turn engine off and allow to cool.

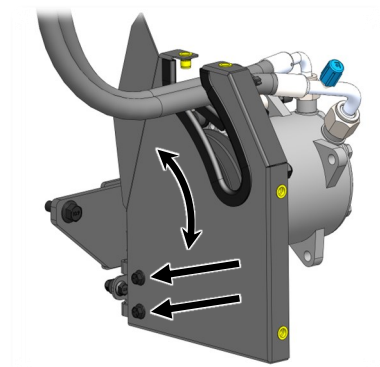

Fig. 9.3 (Install Front Shroud Panel)

# CAB INSTALLATION

## Step 9: (Shroud Installation)

- 9.1 Remove the two OEM bolts shown in Figure 9.1, install the rear shroud bracket, and re-install the bolts.
- 9.2 See fig. 9.2. Install the front shroud bracket oriented as shown so that the bolts for the shroud can be installed from the front. Secure to the pre-existing hole in the vehicle frame.

<u>Hardware Used</u>	<u>Qty</u>
M6x1.0x20mm Flange Bolt	1
M6x1.0 Nylock Nut	1

- 9.3 See fig. 9.3. Assemble the front shroud panel to the front side of the bracket installed in step 9.2. Ensure hoses have ample clearance from panel and tighten the two fasteners.

<u>Hardware Used</u>	<u>Qty</u>
1/4-20x3/4" Flange Bolts	2

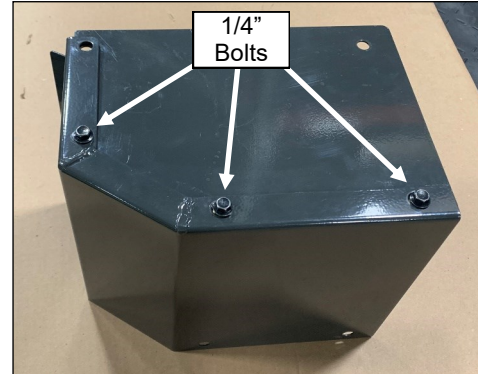

Fig. 9.4 (Assemble Cover Panel)

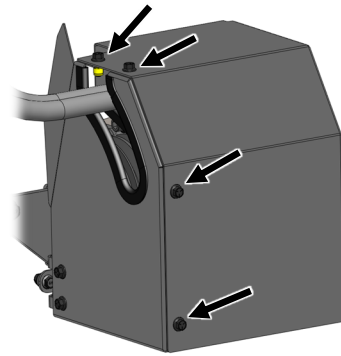

Fig. 9.5 (Install Rear Shroud Panel)

- 9.4 See fig. 9.4. Assemble the rear shroud panel and cover together as shown. Leave the bolts loose at this time.

<u>Hardware Used</u>	<u>Qty</u>
1/4-20x3/4" Flange Bolts	3

- 9.5 See fig. 9.5. Assemble the rear shroud panel over the compressor. Tighten all shroud bolts at this time. Verify that there is clearance all around hoses. Loosen shroud and adjust, if necessary, to gain adequate clearance.

<u>Hardware Used</u>	<u>Qty</u>
1/4-20x3/4" Flange Bolts	6

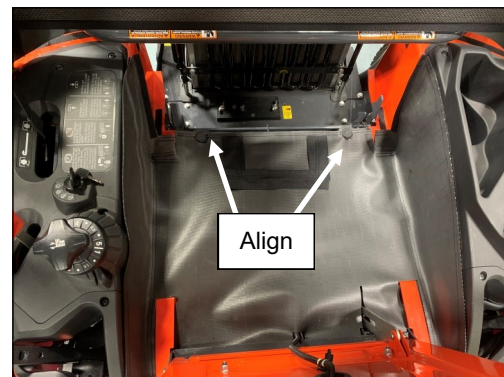

Fig. 10.1 (Install Underseat Filler)

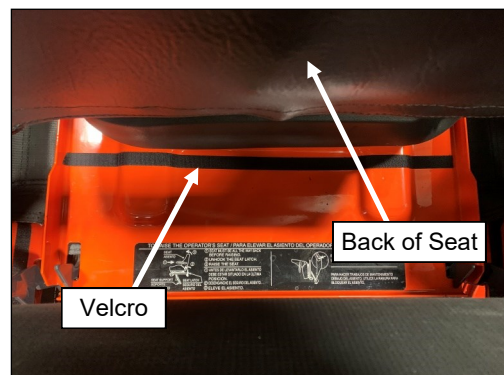

Fig. 10.3 (Install Velcro)

# CAB INSTALLATION

## Step 10: (Filler Installation)

10.1 See fig. 10.1. Raise the seat and install the rubber underseat filler panel as shown. Start by aligning the panel over the round rubber bumpers that the seat rests on and work around the perimeter to attach to the pre-installed Velcro.

10.2 Install Velcro around the perimeter of the underseat filler in the areas where Velcro was not pre-installed using the filler as the locating template for the Velcro. Be sure to wipe down the surfaces where the Velcro will be adhered and that the surfaces are at room temperature.

10.3 See fig. 10.3. Lower the seat, slide the seat completely forward, tilt seat back forward, and install adhesive Velcro to the seat base so that it is located up against the stamped rib as shown.

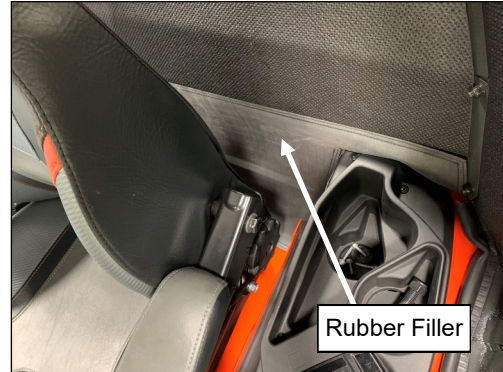

Fig. 10.4 (Filler Location)

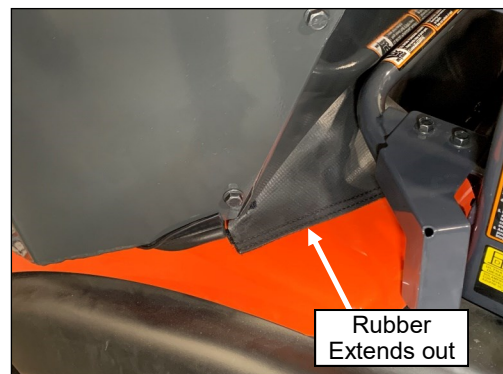

Fig. 10.5 (Filler Location)

10.4 See fig. 10.4. Install the upper portion of the rubber filler along the bottom edge of the rear panel to locate it and then secure under the seat and along the sides.

10.5 See fig. 10.5. The back ends of the rubber filler should be pulled out under the cab so that they can be velcroed to the fenders behind the cab.

10.6 Use the rubber filler as a guide and apply adhesive Velcro to the tractor fenders behind the cab.

## Step 11: (Final Installation)

11.1 See fig. 11.1. Re-install doors and install gas shocks. The end with the red tab should be

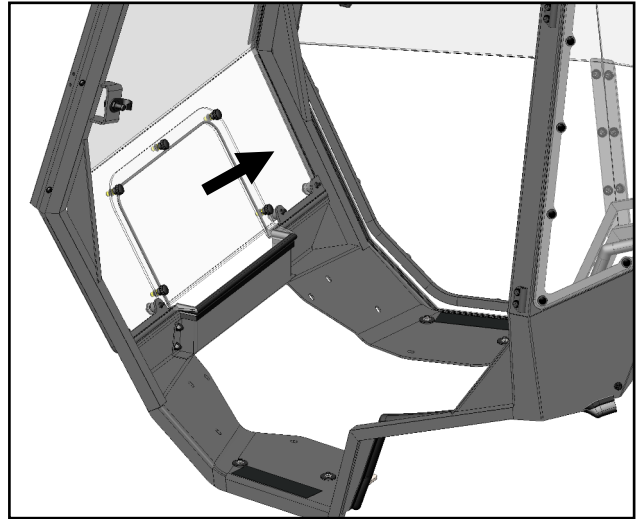

Fig. 11.1 (Attach Gas Shock)

## CAB FEATURES & OPERATION

### REMOVABLE FRONT WINDOW

When pivoting the front axle, remove the (5) thumb nuts securing the front center window. This will allow the front cover to fully open to clear the axle.



Removable Front Window

### AIR CONDITIONING OPERATION

Turn the 4 position ventilation switch to activate the blower. This can be used as just a blower with the A/C compressor turned off.

Rotate the A/C switch to the desired temperature setting to turn the compressor on/off.

In order for the A/C compressor to function, the vehicle throttle must be set at full speed.

The blower must be turned on in order for the A/C compressor to function.

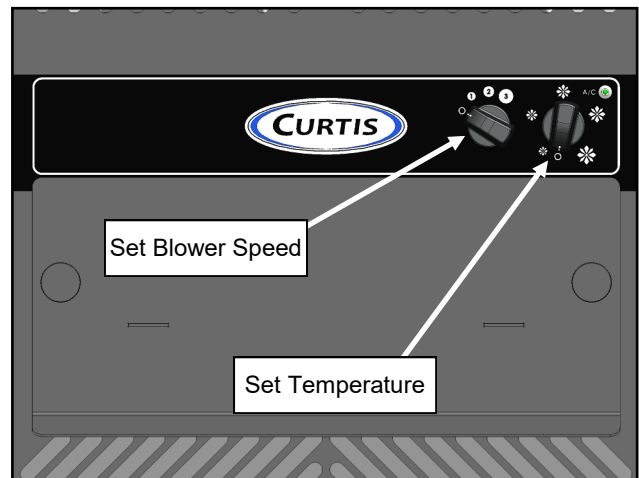

A/C Controls

### AIR FILTER CHECK

Remove the two thumbscrews on the face of the A/C and slide the drawer out to access the air filter.

Change the filter as needed based on operating conditions.

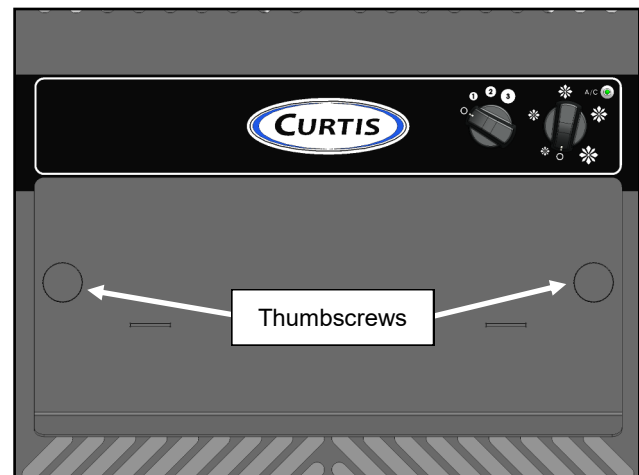

Air Filter Access

## CARE AND MAINTENANCE

- DO NOT use glass cleaner to clean windows. It will damage the material. Mild dish soap and water should be used to clean all window panels. Use a soft bristled brush or sponge to clean panels.
- Avoid wiping the windows while they are dry. Hose down with water to remove heavy debris before wiping windows. Water acts as a lubricant to help prevent scratches.
- Re-apply grease periodically as needed to the door striker pins, door latch assemblies, and the door hinges.
- Check the belt tension after the first 10 hours of use.
- Check and tighten hardware after 40 hours of operation. Periodically inspect and tighten hardware for the remainder of the unit's life. Check for any wearing or chaffing on hoses or wiring and correct as necessary.
- Wash the painted surfaces of the cab with commercial automotive cleaning products.
- Change cabin air filter as required depending on usage conditions.
- Inspect / clean the exterior of the condenser of all dust and debris daily.
- This product is designed with the use of R134a as a refrigerant. Never substitute other refrigerants, use of any other refrigerant will void warranty.
- Charge unit with 2.3 lbs. of R134a refrigerant.
- Apply vacuum for a minimum of 30 minutes prior to charging the air conditioner with R134a.
- Do not vent refrigerant to the atmosphere. If the unit has to be discharged for any reason, recover the refrigerant in compliance with federal, state, and local laws.
- Refrigerant Oil - use only ZEROL ESTER 68SL to replenish any oil lost during refrigerant recovery.
- Replace the drier receiver (9SV-9AC-00003) when replacing a compressor (9SV-9AC-00006).

## TROUBLESHOOTING

- Ensure that throttle lever is activating the switch when moved to its max rpm position. An audible click should be heard when moving the throttle with the vehicle off.
- Check all electrical connections to ensure that proper connections are made and terminals are all tight.
- Check Battery Condition:  
Resting/No Load Voltage should be 12.35V or greater.  
Terminals should be clean and tight.
- Check all fuses:  
30 amp fuse located at battery  
15 amp fuse located near relays, located inside the air conditioner. (accessible with filter drawer removed)  
20 amp fuse located near regulator under operator's seat
- Check both relays. Located inside the air conditioner. (accessible with filter drawer removed)
- Check regulator output. The output should be 12-14 volts DC.
- Check the tension of the OEM and secondary drive belts



## BELT ADJUSTMENT SEQUENCE

Follow this sequence to adjust or replace the OEM V-belt.

Note: The compressor belt must be re-tensioned if the OEM belt requires any adjustment.

**Note: It is critical that the following steps are completed in order and followed closely. Failure to do so may result in vehicle or component damage.**

1. Remove the shroud covering the A/C compressor.
2. Loosen the pivot bolts on the A/C compressor and remove the A/C compressor V-belt.
3. Loosen the bolt on the lower dynamo ear 1/2 turn. See fig. 12.
4. Loosen the nut on the upper dynamo ear 1/2 turn. See fig. 12.
5. Rotate the OEM dynamo to tighten the belt and re-tighten the upper nut on the OEM dynamo. Note: Hold bolt head with a wrench while tightening nut. See fig. 13.
6. Tighten the lower pivot bolt on the OEM dynamo. See fig. 13.
7. Re-install the A/C compressor V-belt and tension.
8. Re-install the shroud over the A/C compressor.

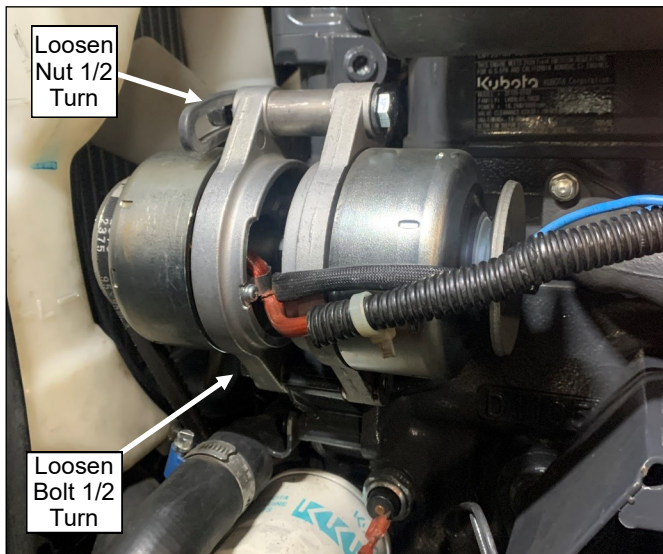

Fig. 12 (Loosen Hardware)

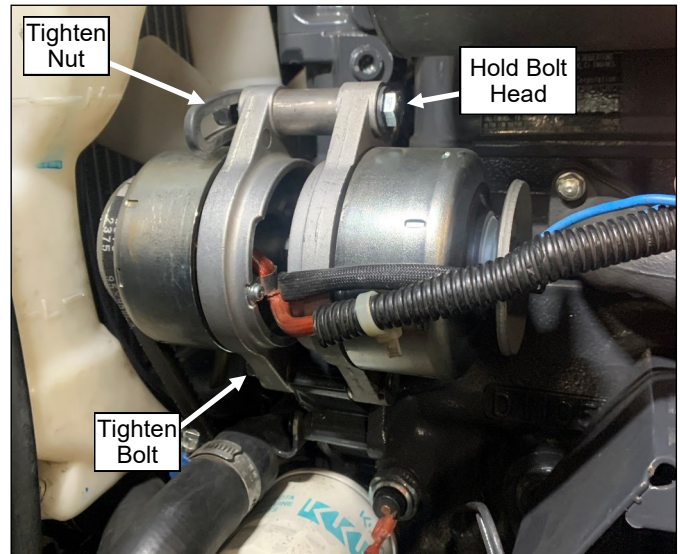

Fig. 13 (Tension Belt, Tighten Hardware)

# DYNAMO SHAFT REPLACEMENT (9SV-MP-00049)

Follow this sequence to replace the dynamo shaft.

**CAUTION: The dynamo shaft is not symmetrical. The Kubota OEM dynamo side of the shaft is shorter than the Curtis dynamo side. The Curtis dynamo side also has a left-handed thread on it to prevent the nut from loosening.**

1. Install the Curtis supplied dynamo onto the long end of the replacement dynamo shaft, as shown below. A rubber or plastic mallet may be required to tap the shaft through the bearings. **Note the orientation of the rotor washer under the rotor cap.** Ensure that the flat washer is centered over the shaft when tightening. Secure with the following hardware and torque to 28.9 to 32.5 ft.-lbs. (39.2 to 44.1 Nm).

### Hardware Used

Hardware Used	Qty
M12x24 Steel Flat Washer	1
M10x18 Split Lock Washer	1
M10x1.25 Left Hand Threaded Nut	1

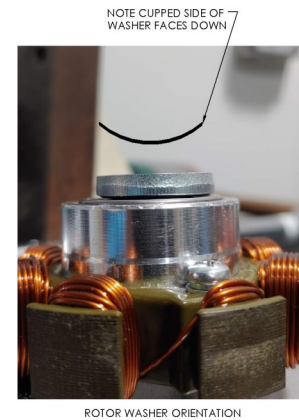
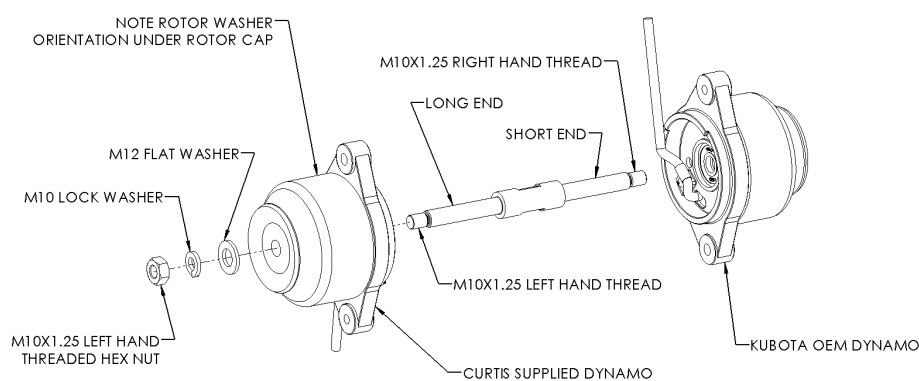

2. Install the OEM dynamo onto the short end of the replacement dynamo shaft. A rubber or plastic mallet may be required to tap the shaft through the bearings. Ensure that the flat washer is centered over the shaft when tightening. Secure with the following hardware and torque to 28.9 to 32.5 ft.-lbs. (39.2 to 44.1 Nm). See **Step 2: (Dynamo Installation)** for more information.

### Hardware Used

Hardware Used	Qty
M12x24 Steel Flat Washer	1
M10x18 Split Lock Washer	1
M10x1.25 Right Hand Threaded Nut	1

Note: The Curtis supplied dynamo can be identified by the Model No: 10932N, as shown in the illustration to the right.



# SERVICE PARTS

ROOF ASSEMBLY  
P/N: 8SV-101-00056

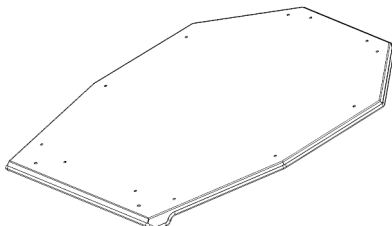

WINDSHIELD ASSEMBLY  
P/N: 8SV-102-00030

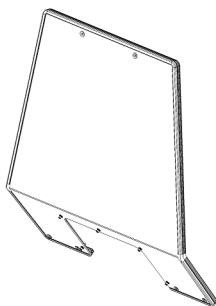

WINDSHIELD SUPPORT ASSEMBLY  
P/N: 8SV-103-00024

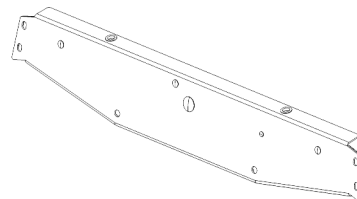

REAR PANEL ASSEMBLY  
P/N: 8SV-106-00036

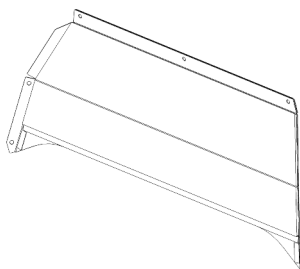

DOOR ASSEMBLY, LEFT  
P/N: 8SV-107-00040-L

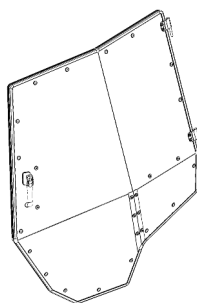

DOOR ASSEMBLY, RIGHT  
P/N: 8SV-107-00040-R

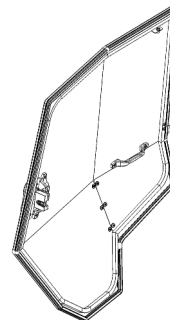

SIDEFAME ASSEMBLY, LEFT  
P/N: 8SV-109-00020-L

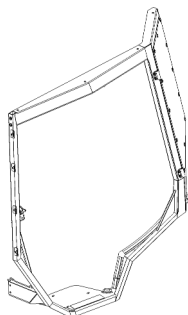

SIDEFAME ASSEMBLY, RIGHT  
P/N: 8SV-109-00020-R

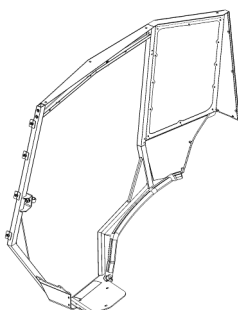

FRONT LOWER CROSS ASSEMBLY  
P/N: 8SV-113-00220

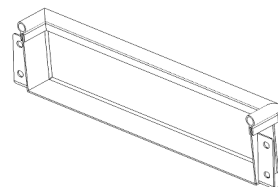

REAR FRAME ASSEMBLY  
P/N: 8SV-113-00221

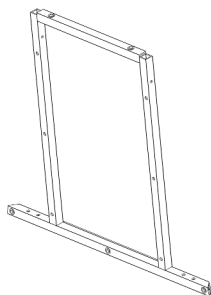

A-PILLAR CLAMP, LEFT  
P/N: 8SV-SM-01727-L



A-PILLAR CLAMP, RIGHT  
P/N: 8SV-SM-01727-R



# SERVICE PARTS

A/C UNIT, REAR MOUNTED  
P/N: 8SV-101-00005-KG

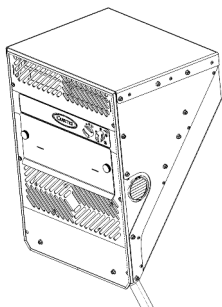

A/C COVER ASSEMBLY  
P/N: 8SV-303-00013-KG

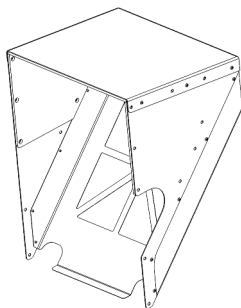

ROPS MOUNT, LEFT  
P/N: 8SV-SM-01715-L

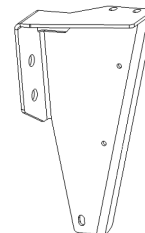

ROPS MOUNT, RIGHT  
P/N: 8SV-SM-01715-R

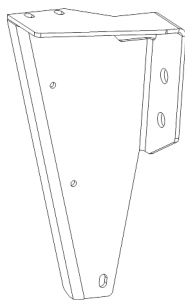

ROPS MOUNT PLATE, UPPER  
P/N: 8SV-SM-02026

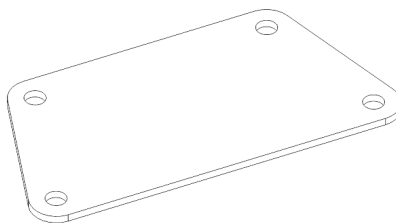

SWITCH BRACKET ASSEMBLY  
P/N: 8SV-113-00227

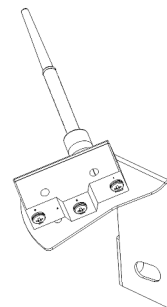

A/C AIR DIVERTER FLAP  
P/N: 8SV-SM-02012

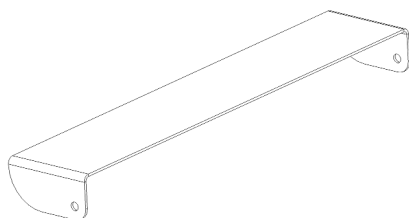

LIMIT SWITCH  
P/N: 9SV-ULS-SWITCH

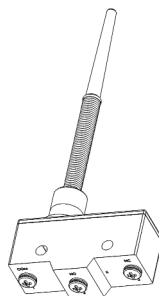

V-BELT  
P/N: 9SV-9BLT-13

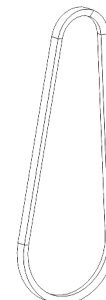

DYNAMO  
P/N: 9SV-9ALT-05

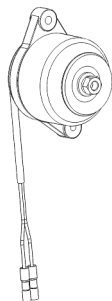

DYNAMO SHAFT  
P/N: 9SV-MP-00049

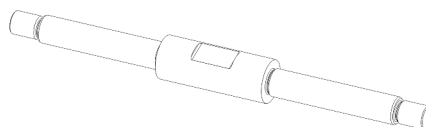

REGULATOR/RECTIFIER  
P/N: 9SV-85-17-0060

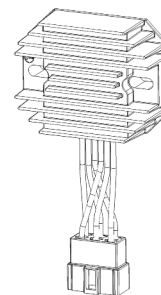

# SERVICE PARTS

SHROUD MOUNT BRACKET, REAR  
P/N: 8SV-110-00088

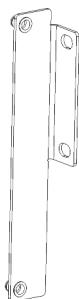

SHROUD MOUNT BRACKET, FRONT  
P/N: 8SV-110-00089

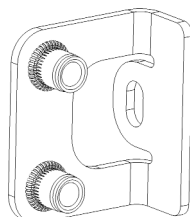

FRONT SHROUD COVER  
P/N: 8SV-113-00236

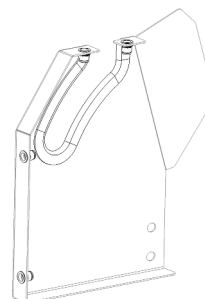

REAR SHROUD COVER  
P/N: 8SV-113-00238

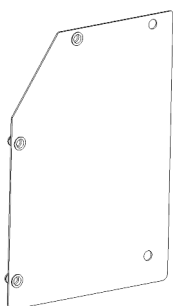

SHROUD COVER  
P/N: 8SV-SM-01880

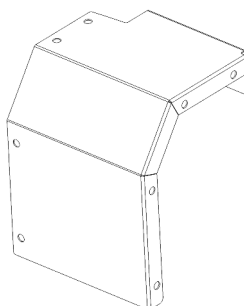

ROPS MOUNT, UPPER  
P/N: 8SV-SM-01916

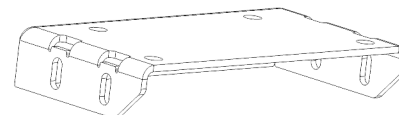

ROPS BRACKET, ROOF TAB  
P/N: 8SV-SM-01917

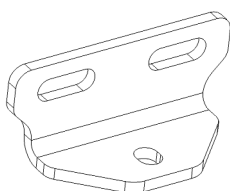

COMPRESSOR ADJUSTMENT ARM  
P/N: 8SV-WA-00421

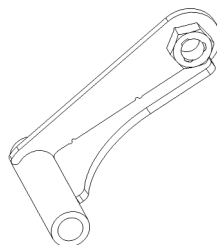

COMPRESSOR BRACKET  
P/N: 8SV-WA-00422

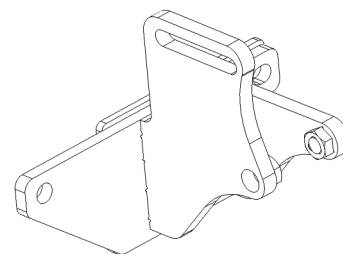

FRONT BRUSH PANEL  
P/N: 8SV-111-00033

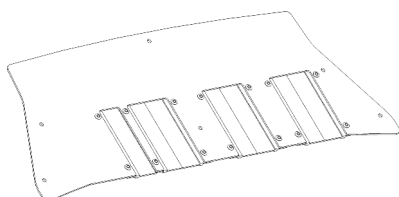

HOSE, #8, COMP TO COND  
P/N: 8SV-305-00022

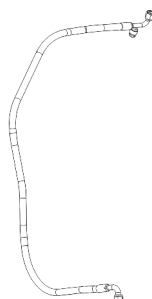

HOSE, #6, DRIER TO EVAP  
P/N: 8SV-305-00023

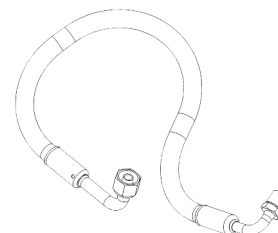

# SERVICE PARTS

HOSE, #10 EVAP TO COMP  
P/N: 8SV-305-00024

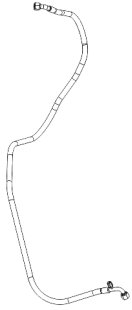

HOSE, #6, COND TO DRYER  
P/N: 8SV-305-00025

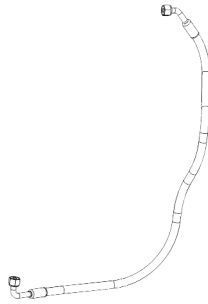

FRONT REMOVABLE PANEL  
P/N: 9SV-P-00132

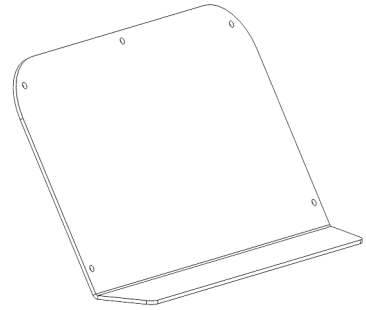

DOOR SKIN, LEFT, W/ HARDWARE  
P/N: 9SV-P-00133-L

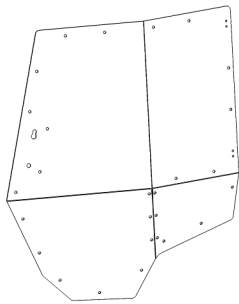

DOOR SKIN, RIGHT, W/ HARDWARE  
P/N: 9SV-P-00133-R

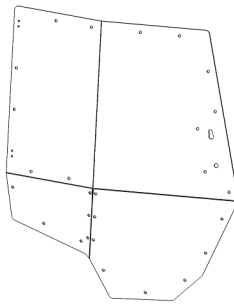

REAR LEG WINDOW, W/ HARDWARE  
P/N: 9SV-P-00128

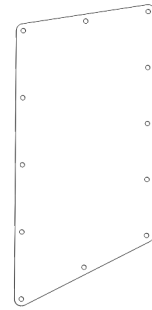

THUMB NUTS (QTY: 5)  
P/N: 9SV-72-89-0094

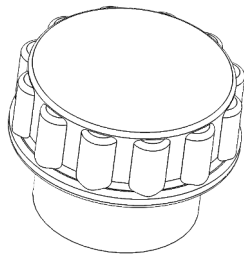

LOUVERED PLUG WITH FILTER  
P/N: 9SV-9DP25



EVAPORATOR  
P/N: 9SV-9AC-00046

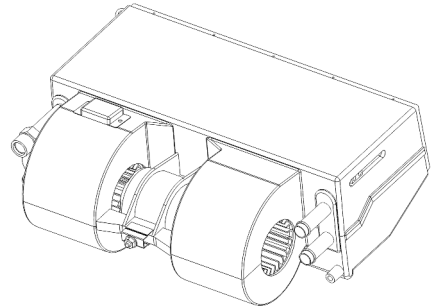

KNOB  
P/N: 9SV-OHC-27

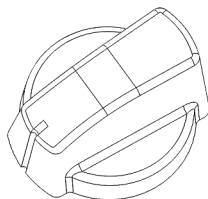

A/C WIRE HARNESS  
P/N: 9SV-WH-00130



AIR FILTER  
P/N: 9SV-9HR-00032

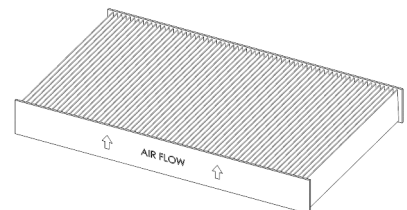

# SERVICE PARTS

A/C COMPRESSOR  
P/N: 9SV-9AC-00043

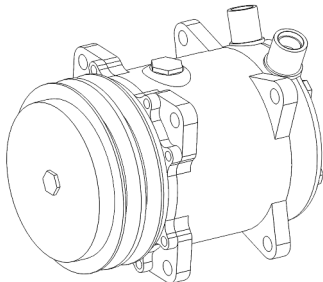

UNDERSEAT FILLER LOWER  
P/N: 8SV-112-00067

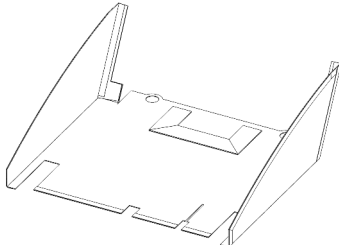

UNDERSEAT FILLER UPPER  
P/N: 8SV-112-00068

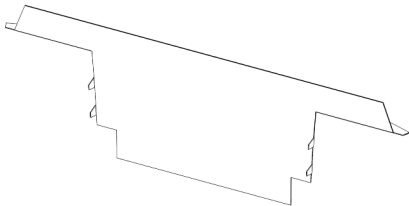

## ADDITIONAL SERVICE PARTS

PART NUMBER	DESCRIPTION
9SV-HWK-00150	HARDWARE KIT, CAB FASTENERS
9SV-HWK-00186	HARDWARE KIT, DOUBLE DYNAMO FASTENERS
9SV-OHRL-G	OUTSIDE DOOR HANDLE (SET OF 2)
9SV-GH	INTERIOR GRAB HANDLE (SET OF 2)
9SV-HSLP	HINGE PINS AND SLEEVES (2L + 2R)
9SV-DP10	DOME PLUG, .375" HOLE (BAG OF 10)
9SV-DP16	DOME PLUG, .750" HOLE (BAG OF 4)
9SV-DP04	DOME PLUG, 1.125" HOLE (BAG OF 15)
9SV-9OR-01	O-RINGS, (INCL 1 OF EA: .301" ID .426" ID .551" ID)
9SV-GS02A	BALL STUD 10MM (BAG OF 10)
9SV-DL06S	INTERIOR DOOR LATCH W/COVER (1L +1R)
9SV-9AC-00001	CONDENSER
9SV-85-01-0022	RELAY, 12V, 20/40A, SPDT, MINI ISO
9SV-9AC-00003	DRIER RECEIVER
9SV-9AC-00005	PRESSURE SWITCH, 2-28KG/CM2
9SV-9AC-00007	AXIAL FAN FOR CONDENSER
9SV-DSTRH	DOOR STRIKER PIN (BAG OF 5)
9SV-GS02Q	GAS SHOCK 12-3/8" (SET OF 2)
9SV-MP-00053-ZC	SPACER, UPPER DYNAMO
9SV-9AC-00046-BS	BLOWER SWITCH
9SV-9AC-00046-TS	THERMOSTAT SWITCH
9SV-KZDSHW	LEFT HANDED HW FOR MOUNTING DYNAMO (1 NUT, 1 FLAT WASHER, 1 LOCK WASHER)

TRIM LOK, STD,  
1/16" - 1/8" GRIP



9SV-PRO1-20

5/8" STD BULB,  
1/16" GRIP



9SV-PRO2-15

3/4" SIDE BULB,  
1/16" GRIP

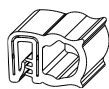

9SV-PR17-20

3/4" SIDE BULB,  
1/4" GRIP

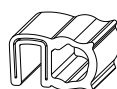

9SV-PR38-15

ARCH PSA,  
.20" X.15"

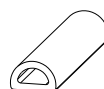

9SV-PR53-15

1" ROUND BULB,  
1/16" GRIP



9SV-PR19-10

1/2"  
WEATHERSEAL



9SV-PR20-10

FOAM TAPE,  
1/8" X 2"



9SV-PR35-5

FOAM TAPE,  
1/8" X 1"



9SV-PR39-5





# BOLT TORQUE

## BOLT TORQUE SPECIFICATIONS

### GENERAL TORQUE SPECIFICATION TABLE

Use the following torques when special torques are not given. These values apply to fasteners as received from suppliers, dry, or when lubricated with normal engine oil. They do not apply if special graphited or moly disulphide greases or other extreme pressure lubricants are used. This applies to both UNF and UNC threads. Remember to always use grade five or better when replacing bolts.

**IMPORTANT: On all PLATED GRADE 8 bolts, reduce torque 15% from listed bolt torque specification.**

SAE Grade No.		2				5				8*			
Bolt head identification mark as per grade. NOTE: Manufacturing Marks Will Vary													
		TORQUE		TORQUE		TORQUE		TORQUE		TORQUE		TORQUE	
Bolt Size		Pounds Feet		Newton-Meters		Pounds Feet		Newton-Meters		Pounds Feet		Newton-Meters	
Inches	Millimeters	Min.	Max.	Min.	Max.	Min.	Max.	Min.	Max.	Min.	Max.	Min.	Max.
1/4	6.35	5	6	7	8	9	11	12	15	12	15	16	20
5/16	7.94	10	12	14	16	17	20.5	23	28	24	29	33	39
3/8	9.53	20	23	27	31	35	42	48	57	45	54	61	73
7/16	11.11	30	35	41	47	54	64	73	87	70	84	95	114
1/2	12.70	45	52	61	70	80	96	109	130	110	132	149	179
9/16	14.29	65	75	88	102	110	132	149	179	160	192	217	260
5/8	15.88	95	105	129	142	150	180	203	244	220	264	298	358
3/4	19.05	150	185	203	251	270	324	366	439	380	456	515	618
7/8	22.23	160	200	217	271	400	480	542	651	600	720	814	976
1	25.40	250	300	339	406	580	696	787	944	900	1080	1220	1464
1-1/8	25.58	-	-	-	-	800	880	1085	1193	1280	1440	1736	1953
1-1/4	31.75	-	-	-	-	1120	1240	1519	1681	1820	2000	2468	2712
1-3/8	34.93	-	-	-	-	1460	1680	1980	2278	2380	2720	3227	3688
1-1/2	38.10	-	-	-	-	1940	2200	2631	2983	3160	3560	4285	4827

\*Thick Nuts must be used with Grade 8 bolts

### METRIC BOLT TORQUE SPECIFICATIONS

Size of Screw	Property Class	Course Thread			Fine Thread		
		Pitch (mm)	Pounds Feet	Newton-Meters	Pitch (mm)	Pounds Feet	Newton-Meters
M6	5.6	1.0	3.6-5.8	4.9-7.9	-	-	-
	8.8		5.8-9.4	7.9-12.7		-	-
	10.9		7.2-10	9.8-13.6		-	-
M8	5.6	1.25	7.2-14	9.8-19	1.0	12-17	16.3-23
	8.8		17-22	23-29.8		19-27	25.7-36.6
	10.9		20-26	27.1-35.2		22-31	29.8-42
M10	5.6	1.5	20-25	27.1-33.9	1.25	20-29	27.1-39.3
	8.8		34-40	46.1-54.2		35-47	47.4-63.7
	10.9		38-46	51.5-62.3		40-52	54.2-70.5
M12	5.6	1.75	28-34	37.9-46.1	1.25	31-41	42-55.6
	8.8		51-59	69.1-79.9		55-68	75.9-92.1
	10.9		57-66	77.2-89.4		62-75	84-101.6
M14	5.6	2.0	49-56	66.4-75.9	1.5	52-64	70.5-86.7
	8.8		81-93	109.8-126		90-106	122-143.6
	10.9		96-109	130.1-147.7		107-124	145-168
M16	5.6	2.0	67-77	90.8-104.3	1.5	69-83	93.6-112.5
	8.8		116-130	157.2-176.2		120-138	162.6-187
	10.9		129-145	174.8-196.5		140-158	189.7-214.1
M18	5.6	2.0	88-100	119.2-136	1.5	100-117	136-158.5
	8.8		150-168	203.3-227.6		177-199	239.8-269.6
	10.9		175-194	237.1-262.9		202-231	273.7-313
M20	5.6	2.5	108-130	146.3-176.2	1.5	132-150	178.9-203.3
	8.8		186-205	252-277.8		206-242	279.1-327.9
	10.9		213-249	288.6-337.4		246-289	333.3-391.6