



**Kawasaki Mule PRO-FXT - A/C Ready
p/n's: 1KAPFXTCA-AC & 1KAPFXTCAS1-AC
fits all Mule Pro 6-Passenger Models**

While this cab kit was designed to fit on the vehicle(s) listed above, manufacturing tolerances and vehicle assembly may affect cab fitment. It is the responsibility of the cab installer to check all vehicle pedals and levers for full functionality and, as required, adjust the cab fitment to prevent any interference of the cab components with the travel of pedals or levers.



Cab Shown with Optional Front Wiper, Lights, and Side View Mirrors

Available Options:

1. Front Wiper Kit (1KAPFXWK)*
 2. Front LED Work Lights (P/N: 1KAPFXFWL)*
 3. Rear LED Work Lights (P/N: 1KAPFXRWL)*
 4. LED Corner Flasher Light Kit (P/N: 1KAPFXCFL)*
 5. Strobe Light (P/N: 9LEDS2)*
 6. Interior Dome Light (P/N 9LEDD14)*
 7. Heater (P/N: 9PH20S61)
 8. Side View Mirrors (P/N: 9PM5)
 9. Rear View Mirror (P/N: 9PM3)
 10. Fuse Panel kit (P/N 1KAPFXFP)
- * Requires Curtis (P/N 1KAPFXFP) or Kawasaki (P/N KAF080-076) Fuse Panel Kit.

Approximate Installation Time *
Experienced Dealer Technician – 4.5 Hours
Average Dealer Technician – 5.5 Hours
Do-It-Yourself – 6.5 Hours

Approximate Product Specifications
Ground to Top of Air Conditioner: 74 inches
Weight: 447 lbs.
Cab Width: 69-1/2 inches

(*=Not including accessories)

The contents of this envelope are the property of the owner. Leave with the owner when installation is complete.

Rev. A, 07/25/2019

KAWASAKI PRO-FXT CAB SERVICE PARTS P/N 1KAPFXTCA-AC & 1KAPFXTCAS1-AC

A/C FRONT CANOPY (ROOF) KIT
P/N: 1ACKAPFXTDXTRFK

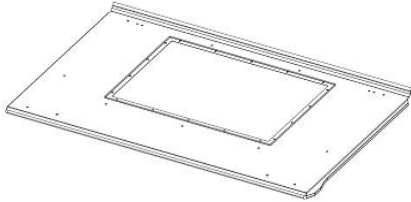

REAR CANOPY ASSEMBLY
P/N: 8SV-101-00007

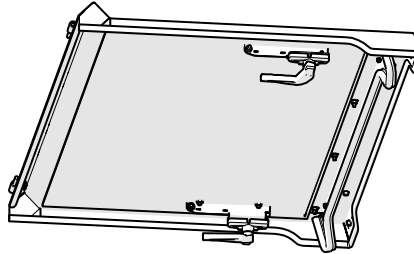

WINDSHIELD ASSEMBLY
POLY. W/S: P/N: 8SV-102-00011
GLASS W/S: P/N: 8SV-102-00020

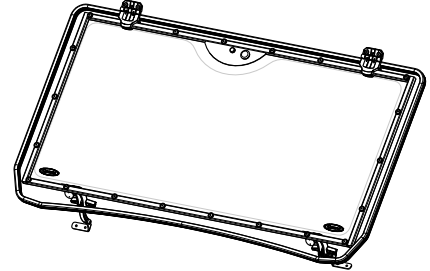

WINDSHIELD SUPPORT ASSEMBLY
P/N: 8SV-103-00006

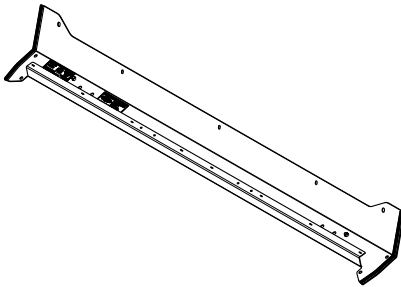

A-PILLAR ASSEMBLY, LEFT
P/N: 8SV-104-00005-L



A-PILLAR ASSEMBLY, RIGHT
P/N: 8SV-104-00005-R

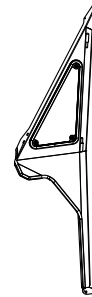

COWL ASSEMBLY
POLY. W/S: P/N: 8SV-105-00008
GLASS W/S: P/N: 8SV-105-00012

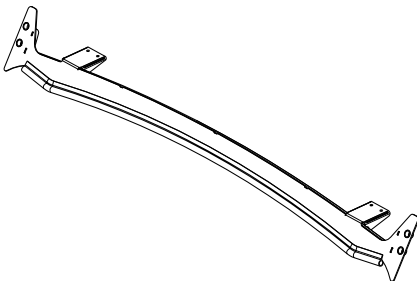

B-PILLAR ASSEMBLY, LEFT
P/N: 8SV-113-00020-L

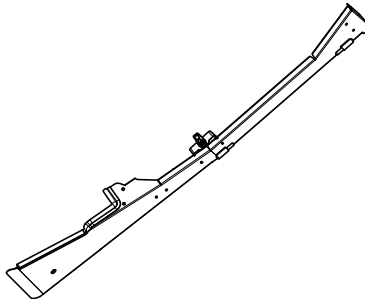

B-PILLAR ASSEMBLY, RIGHT
P/N: 8SV-113-00020-R

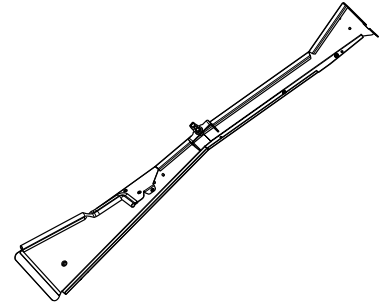

REAR PANEL ASSEMBLY, PFXT
P/N: 8SV-106-00009

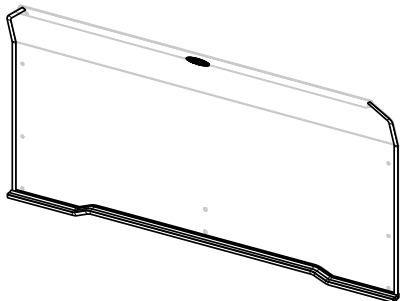

C-PILLAR ASSEMBLY, LEFT
P/N: 8SV-108-00004-L

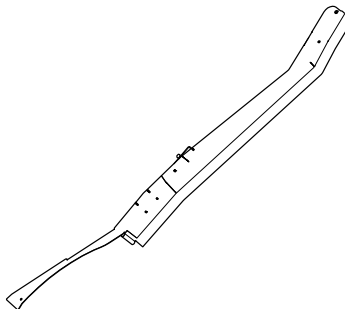

C-PILLAR ASSEMBLY, RIGHT
P/N: 8SV-108-00004-R

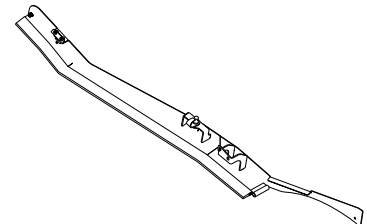

KAWASAKI PRO-FXT CAB SERVICE PARTS

P/N 1KAPFXTCA-AC & 1KAPFXTCAS1-AC

DOOR, LEFT (2 PER CAB)
P/N: 8SV-107-00009-L
(this p/n contains 1 door)

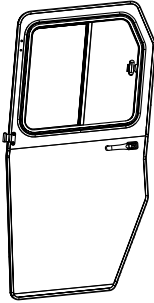

DOOR, REAR RIGHT
P/N: 8SV-107-00009-R

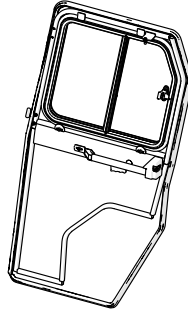

DOOR, FRONT RIGHT
P/N: 8SV-107-00010-R

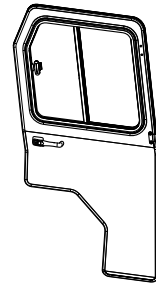

SIDE HEADER, LEFT
P/N: 8SV-113-00021-L

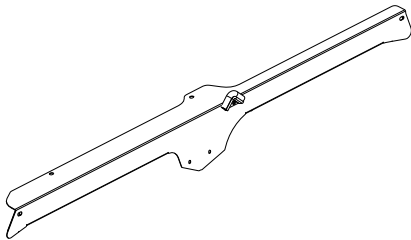

SIDE HEADER, RIGHT
P/N: 8SV-113-00021-R

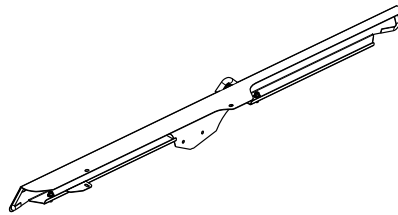

FUEL FILLER COVER PANEL
P/N: 8SV-111-00002

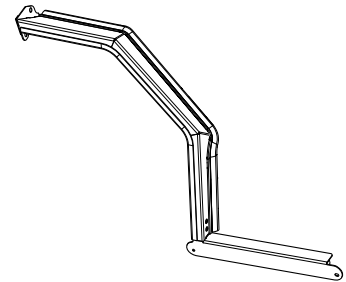

REAR PANEL SIDE, LEFT
P/N: 8SV-111-00004-L

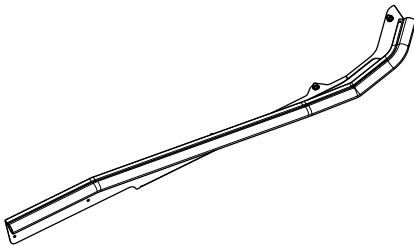

REAR PANEL SIDE, RIGHT
P/N: 8SV-111-00004-R

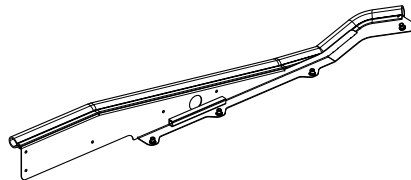

REAR PANEL BED SEAL
P/N: 8SV-9SL-00008

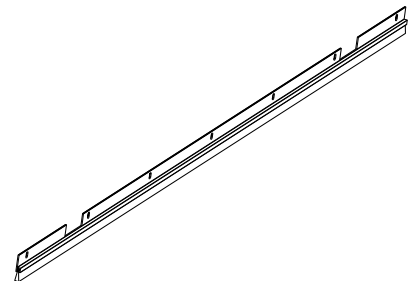

B-PILLAR BRACKET, LEFT
P/N: 8SV-110-00024-L

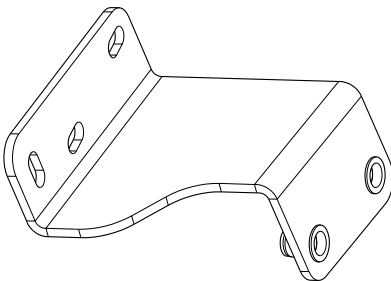

B-PILLAR BRACKET, RIGHT
P/N: 8SV-110-00024-R

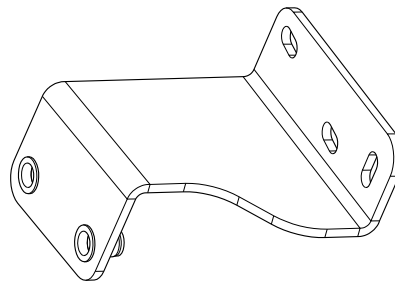

C-PILLAR BRACKET (2 PER CAB)
P/N: 8SV-110-00020
(this p/n contains 1 bracket)

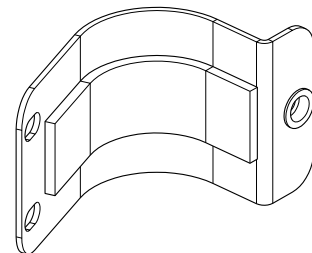

KAWASAKI PRO-FXT CAB SERVICE PARTS

P/N 1KAPFXTCA-AC & 1KAPFXTCAS1-AC

CANOPY GAS SPRING BRACKET, LEFT
P/N: 8SV-110-00019-L

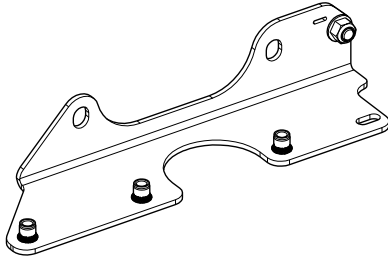

CANOPY GAS SPRING BRACKET, RIGHT
P/N: 8SV-110-00019-R

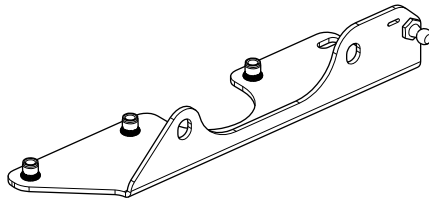

REAR PANEL CENTER BRACKET
P/N: 8SV-110-00025

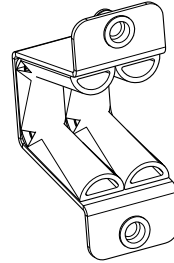

DOOR HINGE KIT
P/N: 8SV-PL-00001

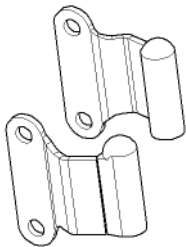

A-PILLAR WINDOW ASS'Y, RIGHT
P/N: 8SV-9GL-00017-R



A-PILLAR WINDOW ASS'Y, LEFT
P/N: 8SV-9GL-00017-L

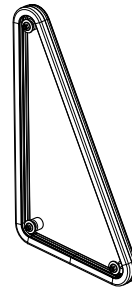



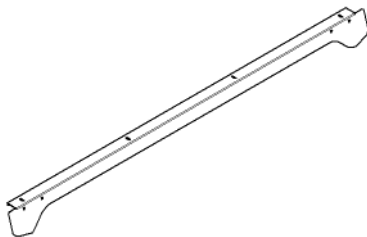





PANEL, UPPER REAR SEAL
P/N: 8SV-SM-00249

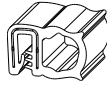

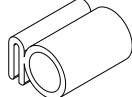
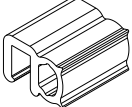
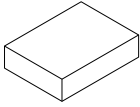
ADDITIONAL SERVICE PARTS

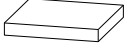
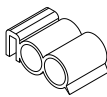
PART NUMBER	DESCRIPTION
8SV-P-00019	WINDSHIELD (POLYCARBONATE WINDOW ONLY) WITH MOUNTING HARDWARE
8SV-WL3	WINDSHIELD LATCH KIT (1 SET, L&R)
9SV-HWS	WINDSHIELD HINGE KIT - POLYCARBONATE WINDSHIELD
9SV-HWSAS1	WINDSHIELD HINGE KIT - GLASS WINDSHIELD
8SV-9GL-00017-L	LEFT A-PILLAR WINDOW, COMPLETE
8SV-9GL-00017-R	RIGHT A-PILLAR WINDOW, COMPLETE
8SV-SM-00223	BRACKET, A-PILLAR MOUNT
8SV-9SW-00007-L	SLIDING WINDOW, LEFT
8SV-9SW-00007-R	SLIDING WINDOW, RIGHT
9SW-LATCH	SLIDING WINDOW REPLACEMENT LATCH
9SV-OHRL	OUTSIDE HANDLE ROTARY LATCH KIT(SET OF 2)
9SV-DL03	INSIDE LATCH KIT WITH GRAB HANDLE (INCL. L & R)
9SV-DSTRH	DOOR STRIKER KIT-INCLUDES CASE HARDENED STRIKER BOLT (SET OF 5)
8SV-VKDRT-B4	DOOR SLIDING WINDOW HOLDING TAB (4)
9SV-VKTHTS	1/4-20 X 3/4" T-HANDLE THUMB SCREW (4)
9SV-GS02A	BALL STUDS, 10MM (BAG OF 10)
9SV-GS02Q	GAS SPRING - 12" W/QUICK RELEASE END (SET OF 2) (FOR GLASS WINDSHIELD ONLY)
9SV-GS06	GAS SPRING - 13-3/4", 500N (SET OF 2) (FOR CANOPY)
9SV-GS12Q	GAS SPRING - 20", 30LBS W/QUICK RELEASE END (SET OF 2) (FOR DOORS)
9SV-PHW010W	HINGE WASHER, WELD-ON, BRASS (BAG OF 4)
9SV-00058	ROOF HINGE KIT #1 (INCL.1 SET OF L & R W/ LOW-PROFILE SLEEVE)
9SV-WL2	LATCH KIT (CANOPY) (SET OF L & R)
9SV-DP10	DOOR PLUG 3/8" (BAG OF 10)
9SV-DP11	DOOR PLUG 1/2" (BAG OF 10)
9SV-HWK-00024	HARDWARE KIT, PFXT

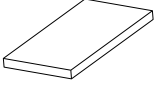
TRIM LOK, STD, 1/16" - 1/8" GRIP  9SV-PRO1-20	5/8" STD BULB, 1/16" GRIP  9SV-PRO2-15	ARCH P.S.A.  9SV-PRO9-10	3/4" SIDE BULB, 1/16" GRIP  9SV-PR17-20	1" ROUND BULB, 1/16" GRIP  9SV-PR19-10	1/2" WEATHERSEAL  9SV-PR20-10
5/8" SIDE BULB 1/16" GRIP  9SV-PR27-5	7/16" SIDE BULB 1/4" GRIP  9SV-PR29-15	EXPANDING FOAM 1/4" x 3/4"  9SV-PR30-5	3/4" SIDE BULB, 1/4" GRIP  9SV-PR38-15	FOAM TAPE, 1/8" X 1"  9SV-PR39-5	1-1/2" SIDE BULB, 1/16" GRIP  9SV-PR41-5
RUBBER FOAM, 1/2" X 9/16"  9SV-PR43-4	2.1" FLAT, 1/16" GRIP  9SV-PR54-5	FOAM TAPE 1/2" X 1/16"  9SV-DT-15			

OPTIONAL ACCESSORIES

FRONT LED WORK LIGHTS
(P/N: 1KAPFXFWL)

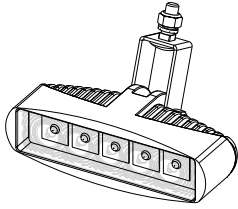

REAR LED WORK LIGHTS
(P/N: 1KAPFXRWL)

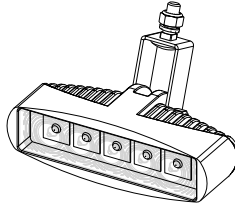

LED CORNER FLASHER LIGHTS
(P/N: 1KAPFXCFL)

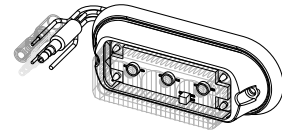

HEATER (P/N: 9PH20S61)

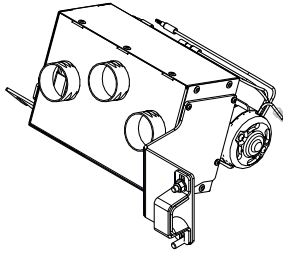

SIDE VIEW MIRRORS (P/N: 9PM5)

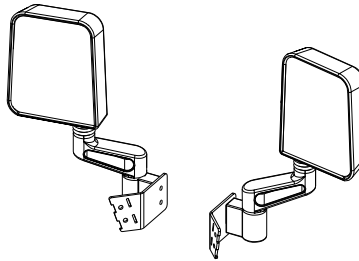

REAR VIEW MIRROR (P/N: 9PM3)

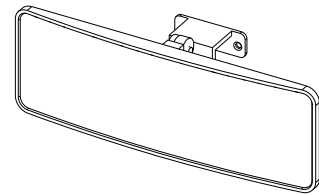

DOME LIGHT (P/N: 9LEDD14)

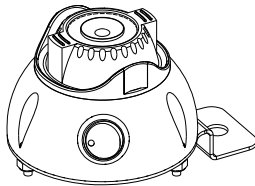

FRONT WIPER KIT, 172 DEGREE SWEEP, 12V W/ 16" FLEX BLADE (P/N: 1KAPFXWK)

