



## INSTALLATION MANUAL STEEL CANOPY

**FOPS Certified (Falling Object Protective Structure)  
(black p/n's: 77700-VC5000, VC5000) (orange p/n's: 77700-VC5001, VC5001)  
KUBOTA RTV-X900, RTV-X1120D, RTV-XG850**

### IMPORTANT!

#### CAB COMPONENT ORDER OF INSTALLATION:

1. Canopy Mounts (Canopy Kit)
2. Windshield Assembly
3. Door Strikers & Hinge Mounts (Door Kit)
4. Rear Panel Assembly
5. Canopy Assembly
6. Door Assemblies

NOTE: Front Heavy Duty Springs (V5218) or Heavy Duty Spring Damper Assembly (V5219) is required if complete cab is installed (RTV-X900, RTV-X1120D, and RTV-XG850).

### CALIFORNIA PROPOSITION 65



**WARNING:**  
Cancer and reproductive harm - [www.P65Warnings.ca.gov](http://www.P65Warnings.ca.gov)

### BEFORE INSTALLING STEEL CANOPY

- Read all instructions and safety instructions in this manual.
- Refer to your machine's operator's manual and safety instructions on your machine's safety decals.
- Wear appropriate personal protective equipment (PPE) when performing work.
- Hang a "**DO NOT OPERATE**" tag in operator station.
- If installing windshield and/or rear panel, install those components before installing canopy.
- If installing work lights, it will ease assembly if they are installed prior to installing canopy onto vehicle.



### WARNING

#### To avoid personal injury or death:

- Cabs, blades, and general accessories add additional weight to the base vehicle. Deduct the accessory's total weight from the vehicle's rated capacity including passenger and driver. Never operate the vehicle outside of its rated weight capacity.
- Exposure to carbon Monoxide can cause illness, serious injury, or death. Never operate vehicle if suspicious of Carbon Monoxide. Inspect exhaust system for leaks monthly. Leaks can result from loose connections, corrosion, cracks, or other damage to the exhaust manifold. If leaks are found, repair or replace exhaust system. Do not use vehicle until repair or replacement is complete.
- This canopy does not provide protection from: a rollover (or other accidents), from flying objects (including golf balls), or from lightning. When lightning threatens, take cover and do not operate vehicle.

**Estimated assembly time: 30 minutes**

■ AVAILABLE REPLACEMENT PARTS

Ref. No.	Part No.	Part Name	QTY	REMARKS
1	77700-05135	Canopy, Steel, orange	1	Code No.: KX9-01O (contains one canopy)
1	77700-05130	Canopy, Steel, black	1	Code No.: KX9-01B (contains one canopy)
2	77700-05131	Canopy Mount, left	1	Code No.: KX9-01AL (contains one mount)
3	77700-05132	Canopy Mount, right	1	Code No.: KX9-01AR (contains one mount)
4	77700-05133	Hardware Kit, Steel Roof	1	Code No.: KX9HWK-01 (contains all items listed below)
5	77700-05134	1/2" w x 9/16" Rubber Foam Weatherseal (92" long)	1	Code No.: 9PR43-92 (contains one strip)

NOTE: Items in hardware kit not sold separately.

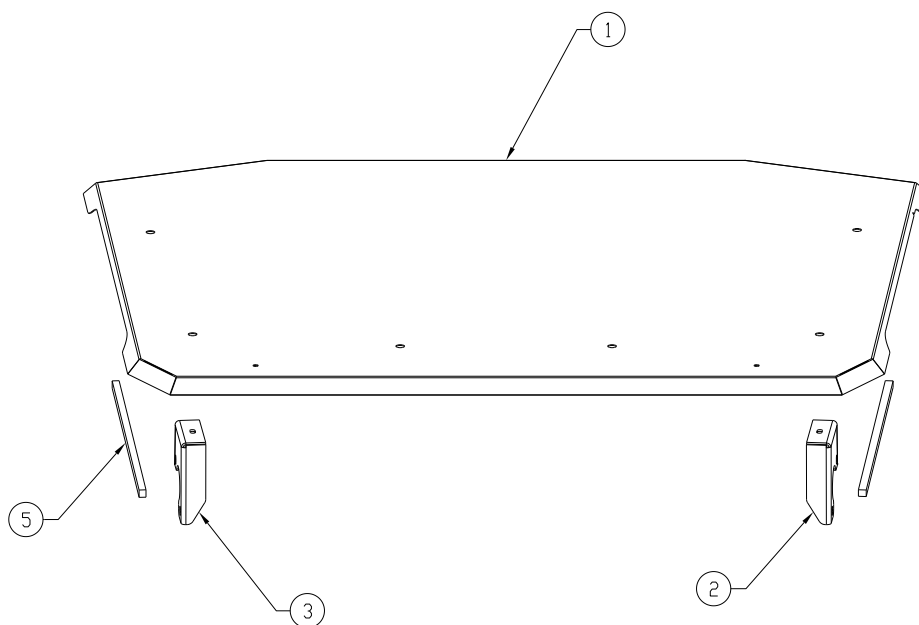

**HARDWARE KIT**

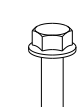

4X — SCREW, HEX FLANGE, 5/16-18 X 1" LG



8X — STEEL FENDER WASHER, 5/16" ID X 1.25" OD



4X — RUBBER FENDER WASHER, 5/16" ID X 1.25" OD



4X — NUT, HEX FLANGE, NYLOC, 5/16-18



2X — STEEL FENDER WASHER, 3/8" ID X 1.25" OD



2X — RUBBER FENDER WASHER, 3/8" ID X 1.25" OD