



**Massey Ferguson 1700E
Cab with Heater (p/n: 1MF1700ECA)
fits tractor models: 1724E, 1725E, 1739E, 1740E, 1825E,
1835E & 1840E with FLx2407 Loader. Adaptor kit allows
cab to fit with some L105E loaders.**

While this cab kit was designed to fit on the vehicle(s) listed above, manufacturing tolerances and vehicle assembly may affect cab fitment. It is the responsibility of the cab installer to check all vehicle pedals and levers for full functionality and, as required, adjust the cab fitment to prevent any interference of the cab components with the travel of pedals or levers.



Shown with L105E newer model adaptor kit.

Available Options:

1. Front LED Work Lights (P/N: 9LEDW4)
2. Rear LED Work Lights (P/N: 9LEDW3)
3. Strobe Light (P/N: 9LEDS2)
4. Dome Light (P/N: 9LEDD14)
5. Side View Mirrors (P/N: 9PM5)
6. Rear View Mirror (P/N: 9PM3)
7. Rear Wiper (P/N: 9PWK8512F9-11A)
8. Adaptor kit for L105E Loader (P/N: 1MF1700EAK) Contact Curtis for details

Approximate Installation Time *
Experienced Dealer Technician – 7 Hours
Average Dealer Technician – 9 Hours
Do-It-Yourself – 11 Hours

(*Including the heater installation)

Approximate Product Specifications
Floorboard to Roof Height: 59.25 inches
Weight: 298 lbs.
Cab Width: 49.37 inches

The contents of this envelope are the property of the owner. Leave with the owner when installation is complete.

MASSEY FERGUSON 1700E CAB SERVICE PARTS

ROOF ASSEMBLY
P/N: 8SV-101-00054

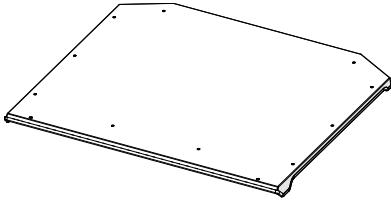

WINDSHIELD ASSEMBLY, 45.75" X 27"
P/N: 8SV-102-00022

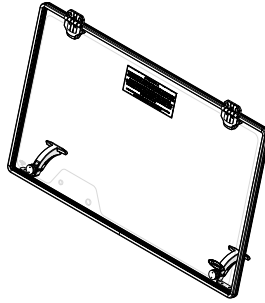

WINDSHIELD SUPPORT
P/N: 8SV-103-00020

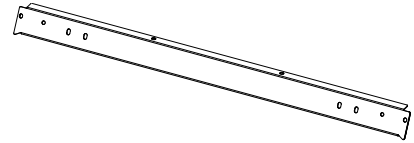

FRONT LEG ASSEMBLY, LEFT & RIGHT
P/N: 8SV-104-00019

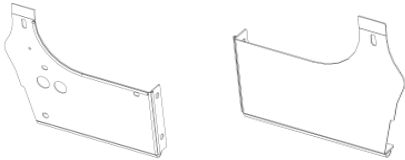

LEFT

RIGHT

COWL ASSEMBLY
P/N: 8SV-105-00028

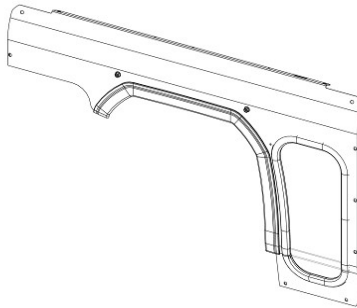

ADAPTERS,
FRONT LEG P/N: 8SV-113-00244

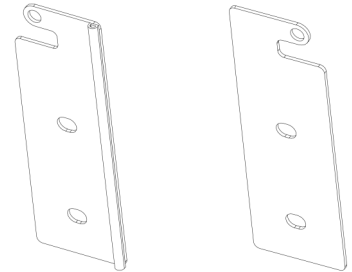

For left side of tractor

For right side of tractor

GLASS REAR PANEL LIFT OFF,
26.75 X 23.25, 3/16" THICK
P/N: 8SV-106-00023

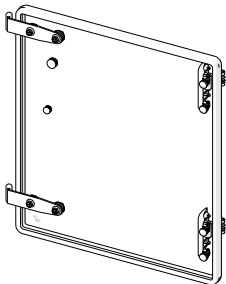

LOWER REAR PANEL
P/N: 8SV-106-00032

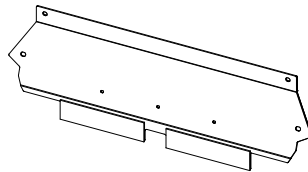

DOOR ASSEMBLY, LEFT
P/N: 8SV-107-00037-L

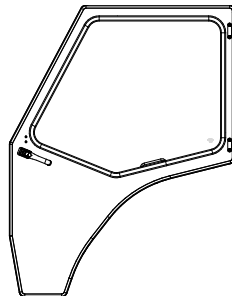

DOOR ASSEMBLY, RIGHT
P/N: 8SV-107-00037-R

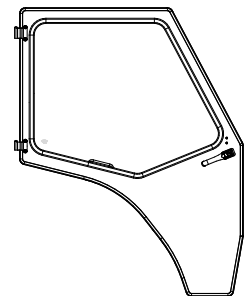

REAR LEG ASSEMBLY, LEFT & RIGHT
P/N: 8SV-108-00020-L & R

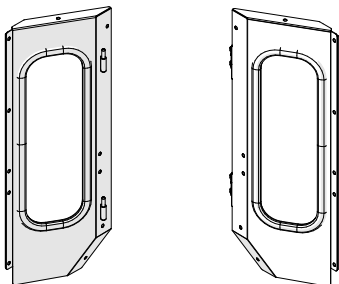

LEFT

RIGHT

COWL INSERT, 1700E
P/N: 8SV-SM-01862



REQUIRED ON
THESE MODELS:
1724E
1739E

SIDE FRAME ASSEMBLY,
LEFT P/N: 8SV-109-00017-L

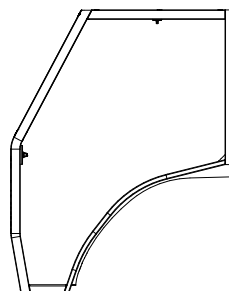

SIDE FRAME ASSEMBLY,
RIGHT P/N: 8SV-109-00017-R

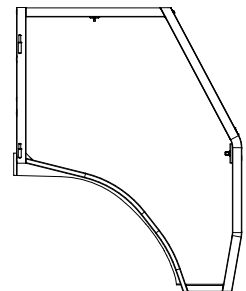

MASSEY FERGUSON 1700E CAB SERVICE PARTS

ROPS BRACKET ASSEMBLY
P/N: 8SV-110-00065

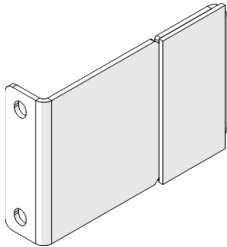

ROPS MOUNT ASSEMBLY
P/N: 8SV-SM-01447-L & R

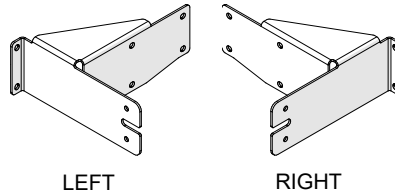

LOADER CONTROL FILLER ASSEMBLY
P/N: 8SV-112-00046

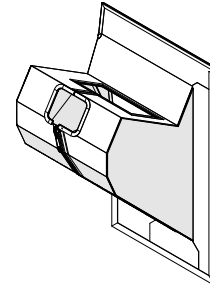

LEFT PEDAL FILLER ASSEMBLY
P/N: 8SV-112-00043

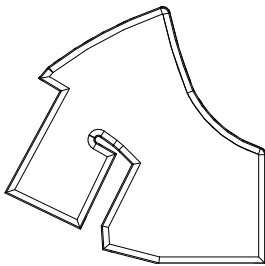

RIGHT PEDAL FILLER ASSEMBLY
P/N: 8SV-112-00044

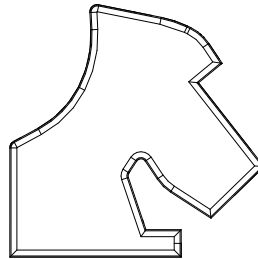

UNDERSEAT FILLER ASSEMBLY
P/N: 8SV-112-00045

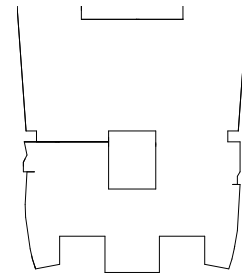

DOOR WINDOW WITH RUBBER
P/N: 8SV-9GL-00054

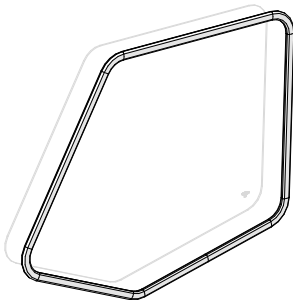

GLASS HINGE SLEEVE WITH
MOUNTING HARDWARE
P/N: 8SV-PL-00021

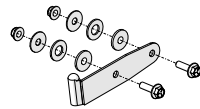

HEATER BRACKET
P/N: 8SV-SM-01275

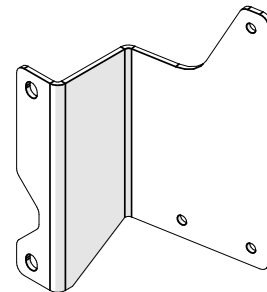

TOOLBOX RELOCATION BRACKET
P/N: 8SV-WA-00337

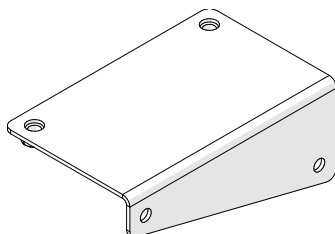

LEFT FLOOR MAT
P/N: 8SV-9FR-00060-L

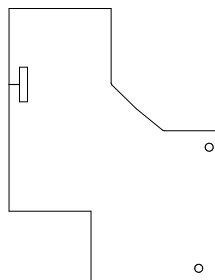



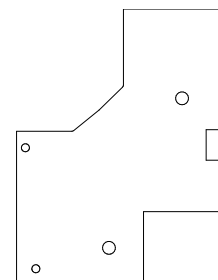



RIGHT FLOOR MAT
P/N: 8SV-9FR-00060-R

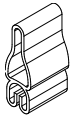

ADDITIONAL SERVICE PARTS

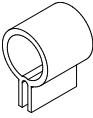
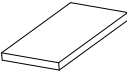
PART NUMBER	DESCRIPTION
8SV-P-00105	REAR LEG WINDOW WITH RUBBER
8SV-P-00106	COWL WINDOW WITH RUBBER
9SV-DP11	DOME PLUG 1/2" (BAG OF 10)
9SV-DP10	DOME PLUG 3/8" (BAG OF 10)
9SV-HWS	WINDSHIELD HINGE KIT
9BLK01	WINDSHIELD HINGE BLOCK SPACER, TALL STYLE, 3/4" THICK
9PWM110	WIPER MOTOR, 110 DEGREE
9PWB20-FB	WIPER BLADE, 20", FLEX
9PWA14-16	WIPER ARM, ADJUSTABLE LENGTH (11" - 16")
9PWK-HB	GLASS MOUNTING KIT FOR WIPER SYSTEMS
9SV-DSTRH	DOOR STRIKER KIT-INCLUDES CASE HARDENED STRIKER BOLT
9SV-IHRL	INSIDE HANDLE ROTARY LATCH KIT (INCL. L & R)
9SV-OHRL	OUTSIDE HANDLE ROTARY LATCH KIT (SET OF 2)
9SV-9PHW010-W	HINGE WASHER, KIT (SET OF 4) OD .635, ID .41, THK .08
9PI01	POLY INSERT 1", 14-20 GA BLK MATTE, INSERT FINES .94/.95 (QTY.: 1)
9PI02	POLY INSERT 3/4", 14-20 GA BLK MATTE FINISH, INSERT FINES 0.69 (QTY.: 1)
9SV-WL1	WINDSHIELD LATCH KIT 1, POPS OPEN W/S FOR VENTING ONLY
8SV-WL3	WINDSHIELD LATCH & BRKT ASS'Y. SGL POST (SET OF L&R)
9SV-GS02Q	GAS SPRINGS, 12-3/8 EXT, QUICK DISCONNECT ENDS (SET OF 2)
9SV-9DPSB	HEATER HOSE BUSHINGS (QTY. 2), SNAP BUSHING, .750" X 1.093"
9SV-9HR-0005	TEE FITTING, 1-1/8" x 1-1/8" x 5/8"
9SV-9HR0039	90 DEGREE HEATER HOSE ELBOW, 5/8" BARBED ENDS
9SV-9HR0045	BLOCK ADAPTER (3/8" NIPPLE)
9SV-9HR0048	ROCKER SWITCH (HI-OFF-LOW)
9SV-9HR00601.0	HOSE CLAMPS #10 (1") (QTY.: 6)
9SV-9HR00601.5	HOSE CLAMPS #16 (1.5") (QTY.: 2)
9SV-HRH61-20	HEATER HOSE (5/8" I.D.)-20 FT
9SV-TBP12920	HARNESS (SPIRAL) WRAP, CUT 20" IN LENGTH
9SV-UHTRILV	UNIVERSAL HEATER IN-LINE VALVE (SET OF 2)
9SV-9HR-L	REPLACEMENT LOUVER-15,000 & 20,000 BTU HEATER, KL47
8SV-9PH20WG	TUCK-AWAY HEATER WITH WIRED GROUND
9PH20-2	FAN 120 x 120 x 38 12VDC 12W 3200 RPM
9SV-WH-00072	WIRING HARNESS POWER
8SV-WH-GF	WIRE HARNESS, GLASS FUSE
9DL01H	KEYS, SET OF 2 ON A RING, FOR HANDLE 1096-1, KEY CODE C40
8SV-HKWCG-L	HINGE KIT, TOP & BOT., LEFT
8SV-HKWCG-R	HINGE KIT, TOP & BOT., RIGHT

TRIM LOK, STD, 1/16" - 1/8" GRIP	5/8" STD BULB, 1/16" GRIP	1" FLAT BULB, 1/16" GRIP	ARCH PSA RUBBER	WINDOW RUBBER	1" STD BULB, 1/16" GRIP	2" SPONGE RUBBER	3/4" SIDE BULB, 1/4" GRIP	ARCH PSA .2 X .15
								
9SV-PRO1-10	9SV-PRO2-15	9SV-PRO5-10	9SV-PRO9-10	9SV-PR10-10	9SV-PR19-10	9SV-PR35-5	9SV-PR38-15	9SV-PR53-15