



**John Deere Z994R  
(p/n: 1JDZ994RPR3)  
Cab with A/C  
(fits both 60" and 72" mower decks.  
Does not fit with mulching or 54" deck)  
Requires Premium Seat**

*While this cab kit was designed to fit on the vehicle listed above, manufacturing tolerances and vehicle assembly may affect cab fitment. It is the responsibility of the cab installer to check all vehicle pedals and levers for full functionality and, as required, adjust the cab fitment to prevent any interference of the cab components with the travel of pedals or levers.*



Premium Cab Shown with Options

Available Options:

1. Side View Mirrors (P/N: 9PM5)
2. Switch Panel (P/N: 1JDZ994RCK) (req'd for following 2 items)
3. Front LED Work Lights (P/N: 1ZTRLK)
4. Front Wiper/Washer Kit (P/N: 1ZTRWK)

Approximate Installation Time *
Experienced Dealer Technician – 4 Hours
Average Dealer Technician – 6 Hours
Do-It-Yourself – 6-8 Hours

Approximate Product Specifications
Floorboard to Roof Height: 59 inches
Weight: 332 lbs.
Cab Width: 50 inches

(\*=Not including accessories)

**Register** your new product quickly online at [Curtiscab.com/product-registration/](http://Curtiscab.com/product-registration/)



Curtis encourages all customers to register their Curtis products. However, failure to do so will not diminish right to warranty. Curtis Industries does not sell or share your information with anyone else.

**Download** a digital copy of your installation instructions online at [Curtiscab.com/literature/](http://Curtiscab.com/literature/)



Curtis strives to continuously improve our products, technical documentation, etc. Therefore, the installation manual for this product may have been updated after your product was packaged. The latest revision of the installation manual can always be found at the website above.

The contents of this envelope are the property of the owner. Leave with the owner when installation is complete.

## TABLE OF CONTENTS

WARNINGS, TIPS, & REQUIRED TOOLS.....	3
VEHICLE PREP.....	4-15
CAB INSTALLATION.....	16-28
CAB FEATURES & OPERATION.....	28
CARE AND MAINTENANCE.....	29
TROUBLESHOOTING.....	29
WIRING SCHEMATIC.....	30
SERVICE PARTS .....	31-37
BOLT TORQUE SPECIFICATIONS .....	38-39





## WARNINGS, TIPS, & REQUIRED TOOLS

*Curtis cabs feature an assembly of parts designed for your vehicle which require adjustment and alignment of components to accommodate vehicle variations and provide proper weather protection. For accurate installation, proper operation, and years of satisfaction, please read and understand the installation and owner's manual fully prior to installing the cab.*

*From all of us at Curtis, we thank you for choosing our product.*

	<b>NOTICE</b>
<p><b>Curtis Cabs, blades and general accessories add additional weight to the base vehicle. All Curtis accessory weights are listed in product brochures. Deduct the accessory's total weight from the vehicle's rated capacity and never exceed the vehicle's rated capacity including driver and passenger.</b></p>	

	<p><b>WARNING</b> <i>Exposure to Carbon Monoxide can Cause illness, serious injury or death. Never operate vehicle if suspicious of Carbon Monoxide. Inspect exhaust system for leaks monthly. Leaks can result from loose connections, corrosion, cracks or other damage to the exhaust manifold. If leaks are found, repair or replace exhaust system. Do not use vehicle until repair or replacement is complete.</i></p>
---	--

	
<b>WARNING</b>	
<b>Serious Injury or Death</b>	
	This cab enclosure does not provide protection from rollover or other accidents.
	This cab enclosure does not provide protection from flying objects including golf balls.
	This cab enclosure does not provide protection from lightning. When lightning threatens take cover and do not operate vehicle.

**California Health and Safety Proposition 65 Warning:** This product may contain chemicals known to the state of California to cause cancer and birth defects or other reproductive harm.

## GENERAL INFORMATION BEFORE YOU START

### HELPFUL HINTS:

- Refer to parts diagram found in the service parts section of this manual to help identify parts during the assembly process.
- To assist with the cab installation, leave all fasteners loose for later adjustment unless otherwise specified.
- Read and understand all instructions before beginning.
- Apply a silicone sealant to seal any minor gaps that may occur due to vehicle variations.
- Use caution to avoid damaging the factory installed threaded inserts or weld nuts. Begin the thread engagement by hand to avoid or correct potential cross threading.
- Make sure the areas where the supplied self-adhesive hook Velcro will be applied are clean and dry and at room temperature for best adhesion.
- Before installing parts with factory installed rubber, make sure the rubber is fully installed onto the parts for proper fit and sealing.

### TOOLS REQUIRED:

- |  |   |
|--|---|
| <ul style="list-style-type: none"> <li>•Set of Standard and Metric Sockets (3/8" + 1/2" Drive)</li> <li>•T25 Torx Bit</li> <li>•3/8" + 1/2" Drive Ratchets and Long Drive Extension</li> <li>•Set of Standard and Metric Open-End Wrenches</li> <li>•Set of Standard and Metric Allen Wrenches</li> <li>•#1, #2, and #3 Phillips Head Screwdrivers</li> <li>•Flat Head Screwdriver</li> <li>•Grease Pencil or Marker</li> <li>•Torque Wrench (3/8" and 1/2" Drive)</li> <li>•Rubber Mallet or Plastic Dead Blow Hammer</li> <li>•Bungee Cord or Twine</li> <li>•Hoisting Strap</li> <li>•Narrow Plastic Putty Knife</li> <li>•Cut-Off Wheel or Jigsaw</li> <li>•3/4" Ratchet Wrench</li> </ul> | <ul style="list-style-type: none"> <li>•Drill/Driver</li> <li>•Center Punch</li> <li>•9/32" Drill Bit</li> <li>•#2 and #3 Phillips Head Bit</li> <li>•Utility Knife</li> <li>•Pair of Scissors</li> <li>•Shears</li> <li>•Grease</li> <li>•Black Silicone Sealant</li> <li>•Steel Straight Edge</li> <li>•Belt tension gauge</li> <li>•Angle Wire Cutters</li> <li>•Needle Nose Pliers</li> </ul> |
|--|---|

# CAB INSTALLATION

## STEP 1: (VEHICLE PREP)

- 1.1 Park vehicle in a location accessible by an overhead hoist.
- 1.2 Disconnect the negative battery terminal.
- 1.3 Remove screw and P-Clamp found on the engine holding wire harness in place. See Fig. 1.3.

### Tools required

13mm socket

- 1.4 Remove cover and grille from vehicle. Set aside grille for later re-work and keep all removed mounting hardware. See Fig. 1.4.

### Tools required

T25 Torx Bit

- 1.5 Per Figure 1.5, cut off the right flange of grille at marked edge. Apply touch-up paint to the cut edges.

### Tools required

Cut-Off Wheel or Jigsaw

- 1.6 Remove right fender.

Remove sleeve and retainer and set aside for later re-installation. Remove bracket and M8X1.25 Lock Nut. See Figures 1.4 & 1.6

Remove Torx fasteners around instrument panel.

Remove two fasteners securing the bottom of the fender.

### Tools required

T25 Torx Bit

10mm socket or wrench

13mm socket and wrench

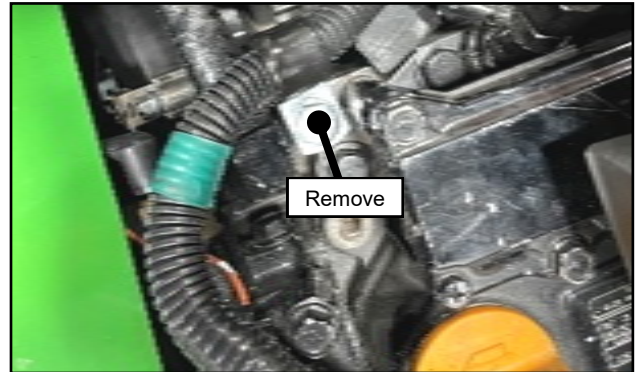

Fig. 1.3 (Remove Screw and P-Clamp)



Fig. 1.4 (Remove Cover and Grille)

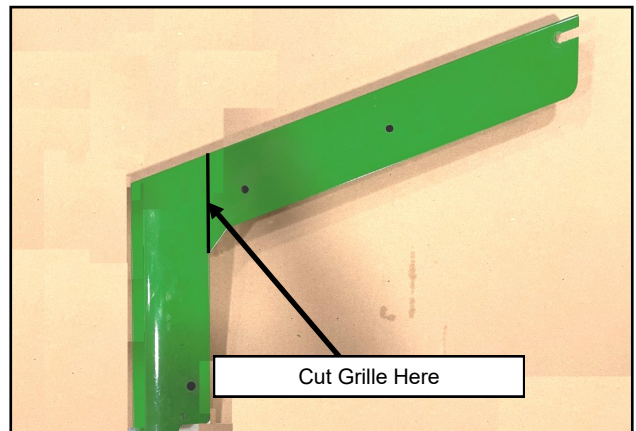

Fig. 1.5 (Cut Right Flange of Grille off)

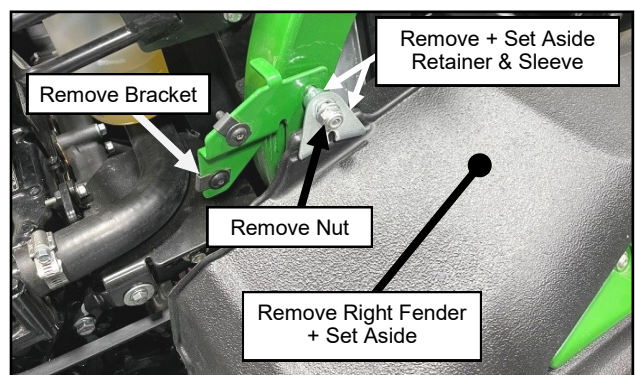

Fig. 1.6 (Remove Right Fender)



# CAB INSTALLATION

## STEP 1: (VEHICLE PREP CONT'D.)

- 1.7 Loosen alternator and remove OEM pulley and spacer.

Install double V-Belt Pulley, per Fig 1.7. Re-tension belt, apply finger pressure to the belt approximately halfway between the alternator and water pump pulleys. Belt should deflect between 3/8"-1/2". Adjust if too tight or too loose.

### Tools required

24mm socket  
13mm socket or wrench  
15mm socket or wrench

- 1.8 Loosen the (2) hose clamps found on the hose connecting the engine to the air cleaner. Next, remove the air cleaner and (2) mounting screws/nuts from the mounting bracket. Set aside hose, air cleaner and hardware for later re-installation. See Figure 1.8.

**Assembly Tip:** For easier removal of air cleaner and later install, remove Cover found over the radiator.

**CAUTION!: DO NOT RUN THE VEHICLE UNTIL STEP 2.38.**

### Tools required

13mm socket or wrench  
5/16" socket or wrench

- 1.9 Remove cover from 2-pin connector found on right side of vehicle. Next, cut wire tie and ensure connector is accessible. See Figure 1.9.

### Tools required

Angle Wire Cutters

- 1.10 Install spacer on outside of compressor mounting bracket as shown on Fig 1.10. Use hardware listed below.

### Hardware Used

Hardware Used	Qty
1/4-20X1" Button Head Cap Screw	1
1/4-20 Flange Lock Nut	1

### Tools required

5/32" Allen Wrench  
7/16" Socket or Wrench

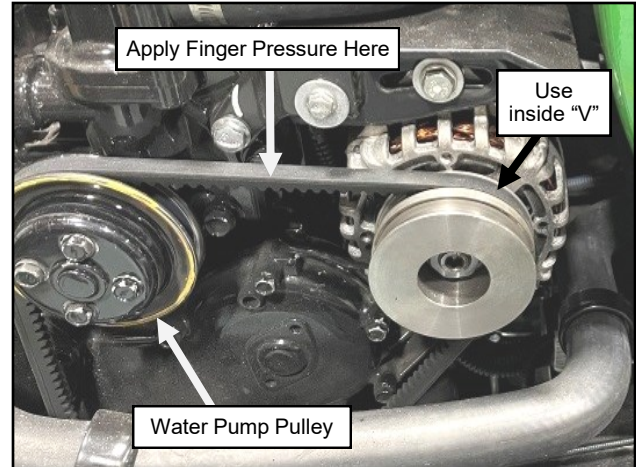

Fig. 1.7 (Install Double V-Pulley)

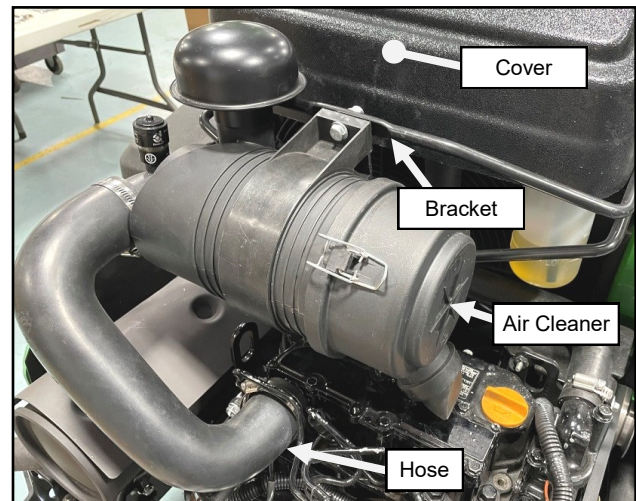

Fig. 1.8 (Remove Hose and Air Cleaner)

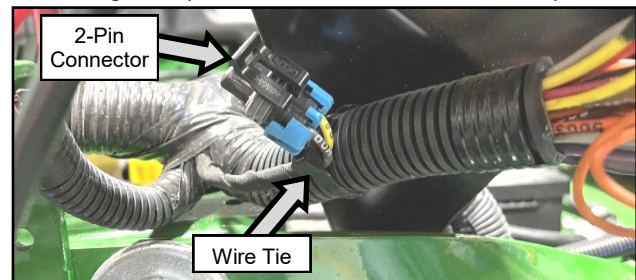

Fig. 1.9 (Remove Cover from 2-Pin Connector)

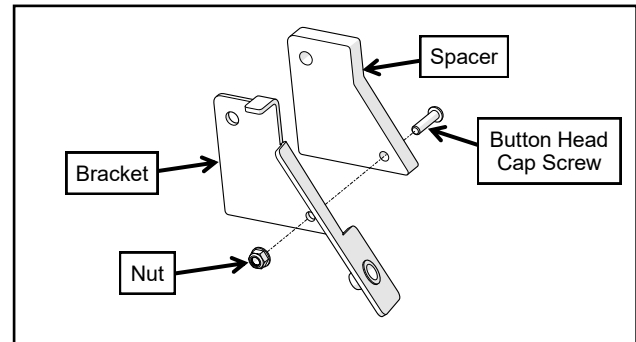

Fig. 1.10 (Install Spacer to Bracket)

# CAB INSTALLATION

## STEP 1: (VEHICLE PREP CONT'D.)

**1.11** Install Bracket and Spacer assembly from Step 1.10, on the outside of the right R.O.P.S. as well as the sleeve and retainer with new M8X1.25 Nut per fig 1.11. Leave hardware loose.

<b>Hardware Used</b>	<b>Qty</b>
M8X1.25 Lock Nut	1

**Tools required**  
13mm socket and wrench

**1.12** Re-install right fender removed from step 1.4. At this time, leave hardware installed on step 1.11 loose. See Figure 1.12.

**Tools required**  
T25 Torx Bit  
10mm socket or wrench  
13mm socket and wrench

**1.13** Remove and set aside footrests (this includes bolts, fender washers, and nuts). Next, remove M10 Carriage bolt and nut found below brake pedal. See Fig. 1.13.

**Tools required**  
13mm socket and wrench  
15mm socket

**1.14** Remove (2) M10 lock nuts and washers from the left side of the vehicle's caster arm per Fig. 1.14a. Install front mount using the recently removed M10 lock nut. Leave mounts loose per Fig. 1.14b. Repeat on right side of vehicle.

**Tools required**  
18mm wrench  
19mm socket

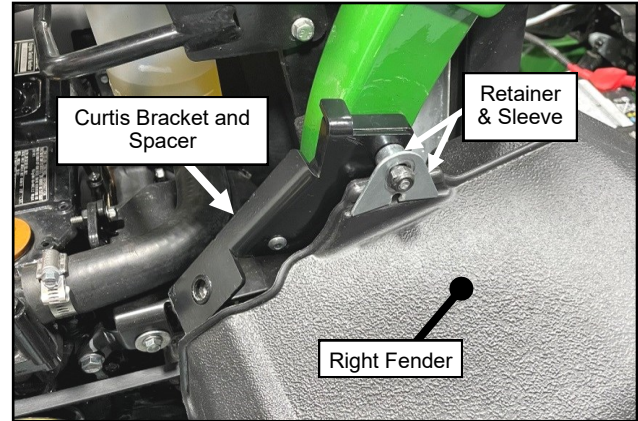

Fig. 1.11 (Install Bracket & Spacer)



Fig. 1.12 (Re-Install Right Fender)

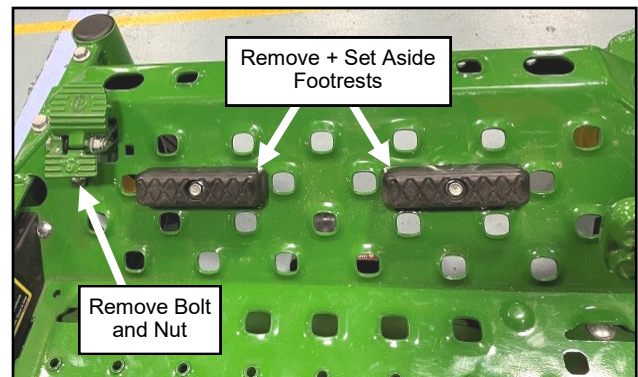

Fig. 1.13 (Remove Footrests & Brake Pedal Bolt)

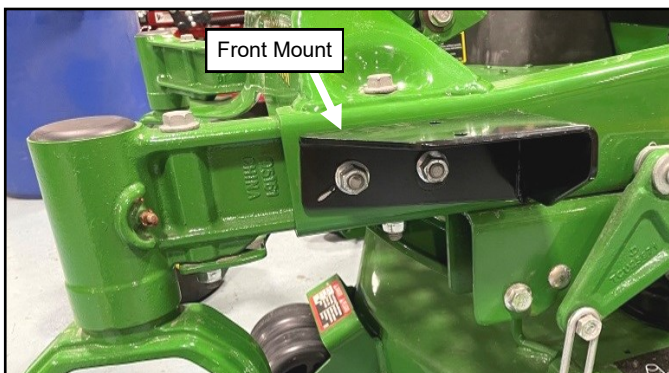

Fig. 1.14b (Install Front Mount, Left Side)

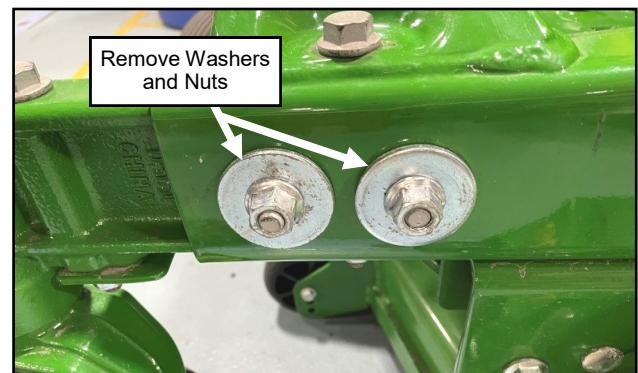

Fig. 1.14a (Remove M12 Washers and Nuts)



# CAB INSTALLATION

## STEP 1: (VEHICLE PREP CONT'D.)

**1.15** Remove ballast box from shipping pallet. Next, install ballast box on the front edge, of the vehicle. Install top bolts first into the vehicle's floorboard (do not fully tighten). Place backing plate between the underside of the floorboard and locking nuts. Next, install front lower carriage bolts from inside the vehicle floorboard outwards to the front of the vehicle. To tighten down the lock nuts, you will need a 3/4" ratchet wrench to access the nuts found on the inside of the ballast box. Fully tighten the front bolts and then the top bolts. See Figures 1.15a and 1.15b.

### Hardware Used

	Qty
1/2-13X1-1/4" Carriage Bolt	4
1/2-13 Flange Lock Nut	4

### Tools required

3/4" Ratchet Wrench  
3/4" Socket or Wrench

**1.16** Place the footrest lip floormat on the vehicle. Place floormat material found on the lower right and left into the sides of the vehicle frame. Install 5/16" hardware into square hole to the right of the pedal. Next, install 3/8" hardware below the pedal making sure 3/8" washers are wedged between the vehicle and clipped washer. Re-install the vehicle footrests. Now fully tighten hardware. See Figures 1.16a and 1.16b.

### Hardware Used

	Qty
3/8-16X1-1/2" Flange Hex Screw	1
3/8" Clipped Washer (in Hardware Box)	1
3/8" Washer	2
3/8-16 Flange Lock Nut	1
5/16-18X1" Flange Hex Screw	1
5/16" Fender Washer	1
5/16-18 Flange Lock Nut	1

### Tools required

13mm socket and wrench  
1/2" socket and wrench  
9/16" socket and wrench

**1.17** Install the footrest floormat making sure the rubber is on the top surface (foam on bottom). Push the extra material into the back edge and sides to fully seal the floorboard. See Fig. 1.17.

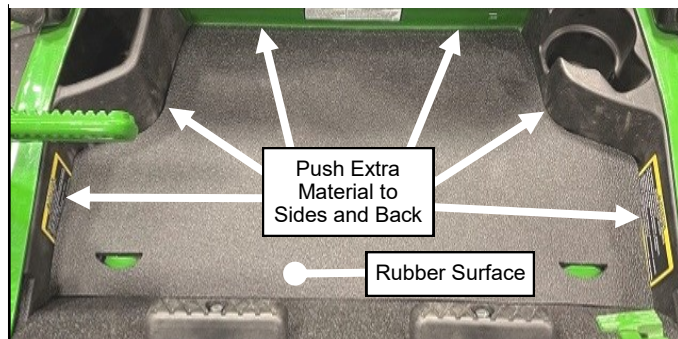

Fig. 1.17 (Install Footrest Floormat)

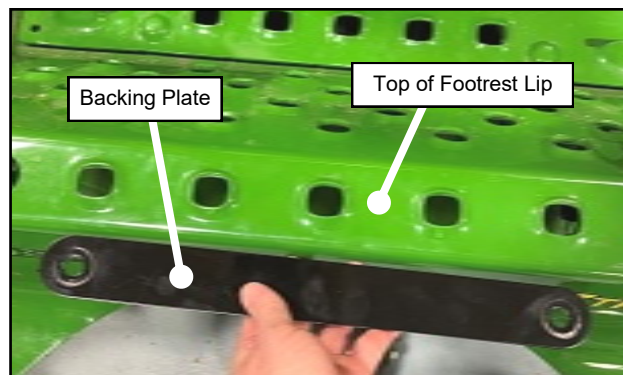

Fig. 1.15a (Install Ballast Box, Backing Plate)

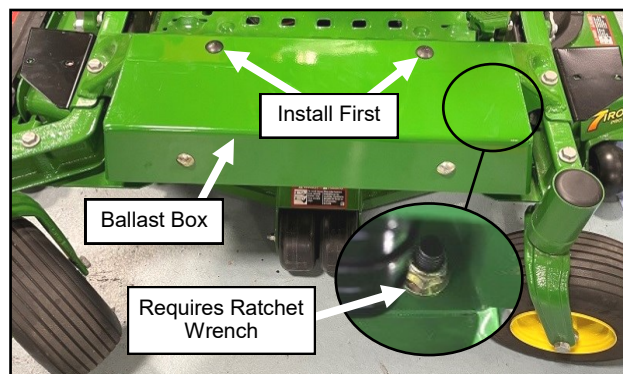

Fig. 1.15b (Install Ballast Box)

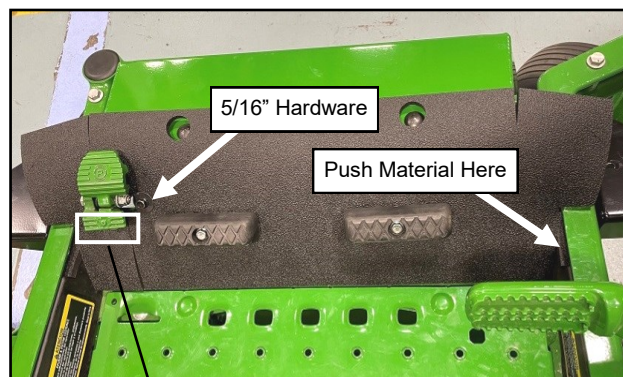

Fig. 1.16a (Install Footrest Lip Floormat)

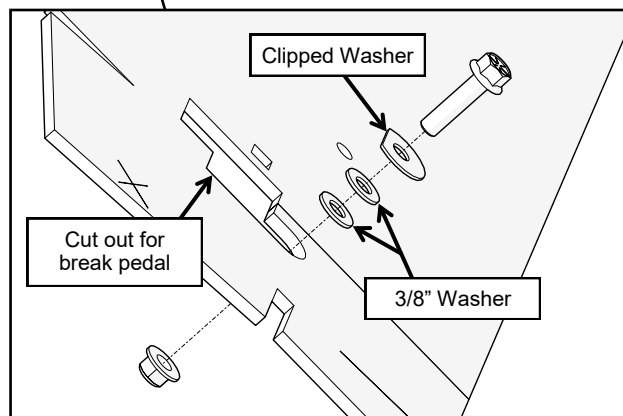

Fig. 1.16b (Brake Pedal Hardware)

# CAB INSTALLATION

## STEP 1: (VEHICLE PREP CONT'D.)

1.18 Tilt the seat forward.

1.19 Disconnect 2-pin connector from the underside of the seat.

Remove harness clip from the seat frame.

Remove/set aside spring lock pin from prop rod.

While holding the seat, remove the prop rod from the seat frame and set the seat back down. See Figure 1.19.

### Tools required

Needle Nose Pliers

1.20 Remove and save seat frame hinge bolts and nuts per Fig. 1.20. Remove seat from vehicle.

### Tools required

13mm socket and wrench



Fig. 1.18 (Tilt Seat Forward)

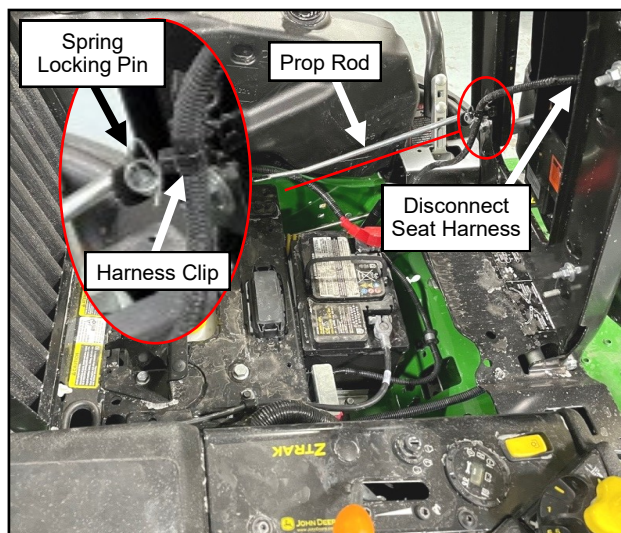

Fig. 1.19 (Disconnect Seat Connector & Prop Rod)

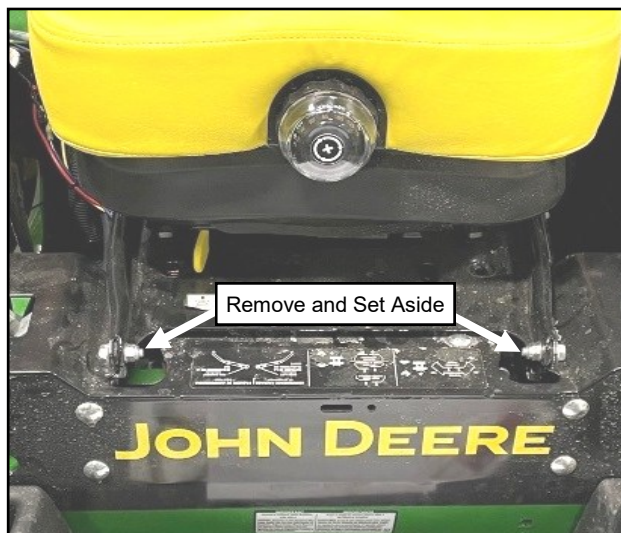

Fig. 1.20 (Remove Front Hinge Bolts)



# CAB INSTALLATION

## STEP 1: (VEHICLE PREP CONT'D.)

1.21 Apply 5/8" wide P.S.A. Velcro to the bottom edge of Arm Restrictors. See Fig. 1.21.

### Tools required

Scissors

1.22 Install the arm restrictors using 1/4-20 hardware, making sure the locating pin is on the front hole as shown in Figure 1.22.

### Hardware Used

	<u>Qty</u>
1/4-20X3/4" Flange Hex Screw	2
1/4-20 Flange Lock Nut	2

### Tools required

3/8" socket  
7/16" wrench

1.23 Install (13) pieces of Velcro as shown in Figure 1.23.

### Tools required

Scissors

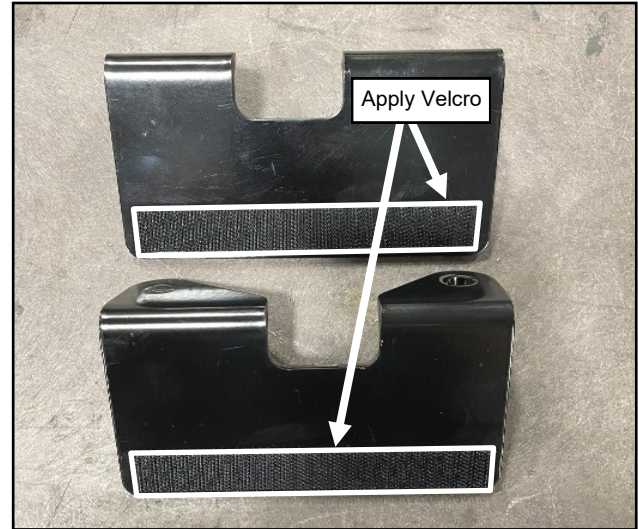

Fig. 1.21 (Install Velcro to Arm Restrictors)

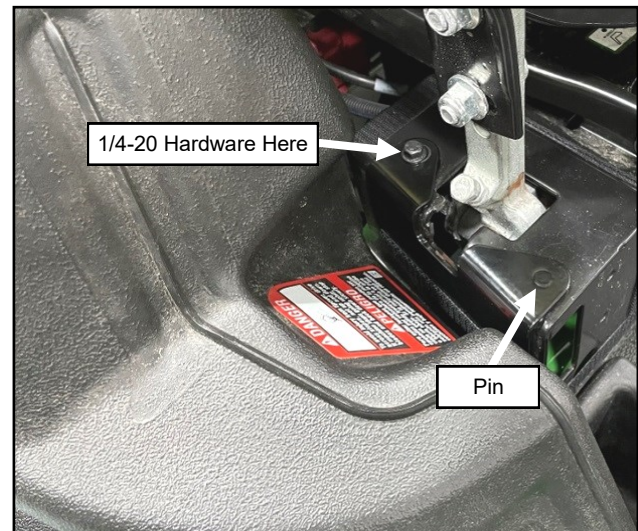

Fig. 1.22 (Install Arm Restrictors, Right)

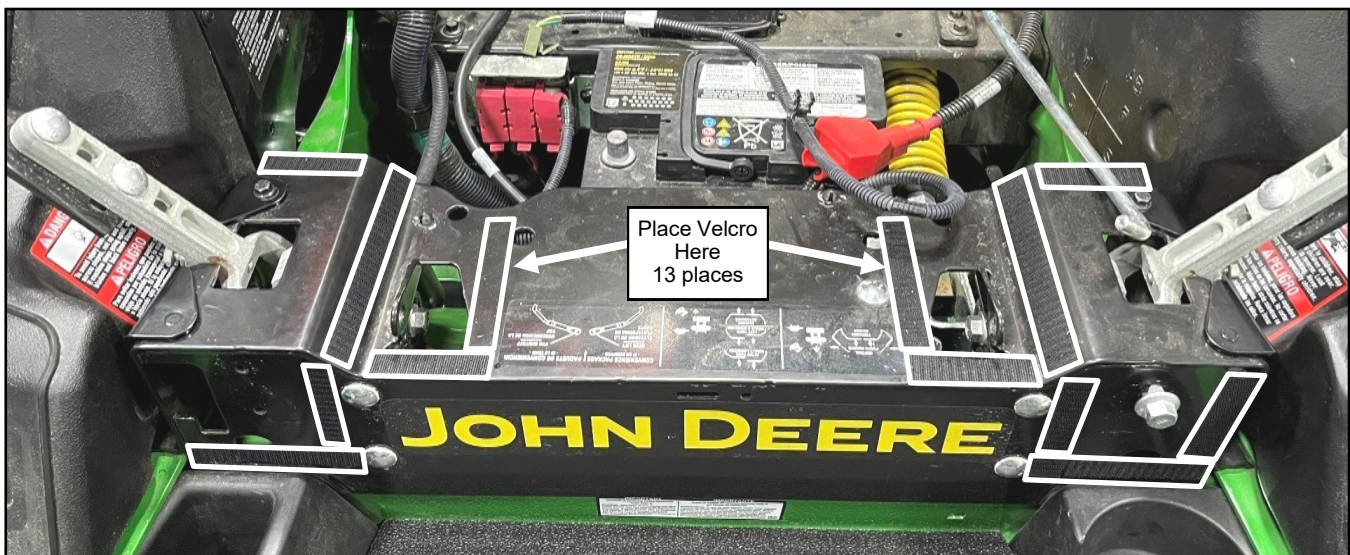

Fig. 1.23 (Install Velcro)



# CAB INSTALLATION

## STEP 1: (VEHICLE PREP CONT'D.)

**1.24** Remove and set aside the (4) nuts and washers holding the seat frame to the seat adjuster rails. Next, remove frame from the seat. See Figure 1.24.

**Tools required**

13mm deep socket

**1.25** Install (4) Clip-On Nuts using a socket to push them onto the screws going through the (2) adjuster rails. See Figure 1.25 with detail.

**Hardware Used**

M8X1.25 Clip-On Nut

**Qty**

4

**Tools required**

7/16" deep socket

Socket wrench extension

**1.26** Place supplied seat pan assembly onto seat. Next, re-install seat frame onto the seat pan. Loosely install OEM washers and nuts back on. Fully tighten left side hardware first followed by the right side. See Figures 1.24 and 1.26.

**Tools required**

13mm deep socket

**1.27** Install supplied release lever by pushing through the underside of seat pan's rubber filler. Placing the hole of the lever onto the seat frame's latch bar mounting bolt and the fork of the lever onto the latch bar. Install lock nut onto the mounting bolt. See Figures 1.26 and 1.27.

**Hardware Used**

M10X1.5 Hex Lock Nut

**Qty**

1

**Tools required**

17mm wrench and socket

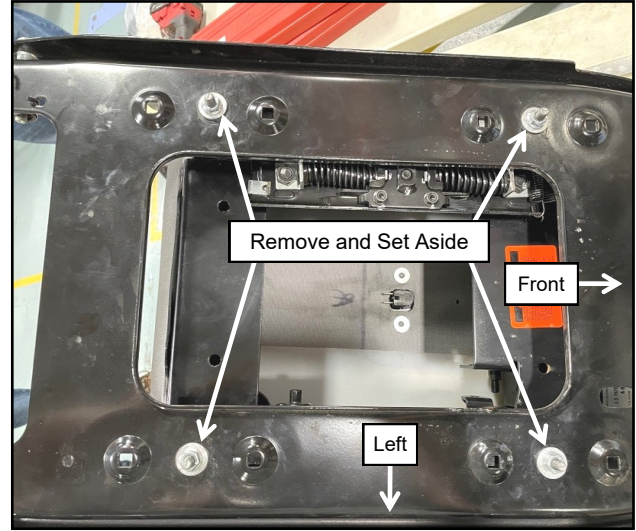

Fig. 1.24 (Remove Seat Frame)

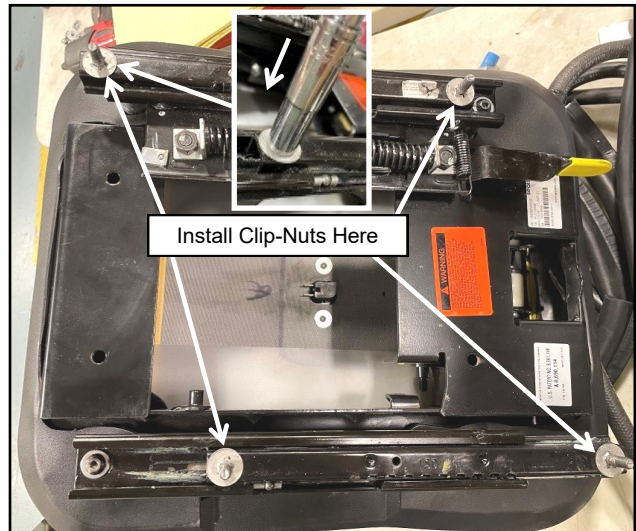

Fig. 1.25 (Install (4) Clip-On Nuts)



Fig. 1.28 (Install Release Lever)

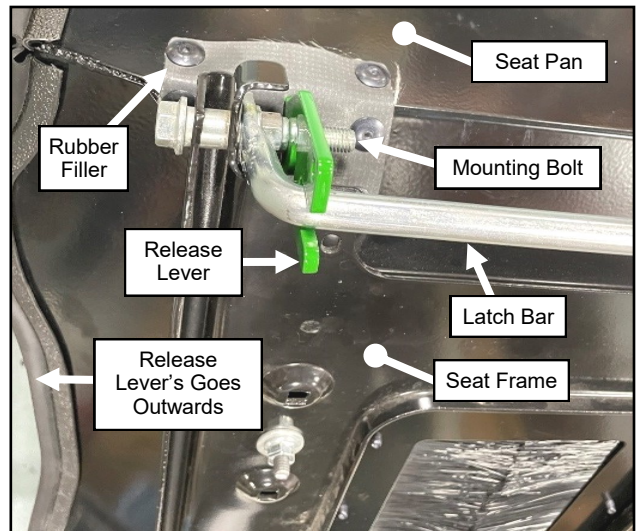

Fig. 1.26 (Install Seat Pan Assembly)



# CAB INSTALLATION

## STEP 1: (VEHICLE PREP CONT'D.)

**1.28** Re-install seat with seat pan assembly back onto the vehicle by re-installing OEM hinge bolts and nuts per figure 1.28.

**Tools required**

13mm socket and wrench

**1.29** Tilt the seat forward, while holding the seat, re-install the prop rod to the seat frame and re-install spring lock pin. Next, reconnect 2-pin connector from the underside of the seat and re-install the harness clip to the seat frame. Lower the seat back down. See Figure 1.29.

**Tools required**

Needle Nose Pliers

**1.30** Install left and right R.O.P.S. brackets onto the vehicle's R.O.P.S. See Figures 1.30a and 1.30b.

**Hardware Used**

	<b>Qty</b>
5/8-11X1-1/4" Hex Flange Bolt	4
5/8-11 Flange Hex Lock Nut	4

**Tools required**

15/16" wrench and socket

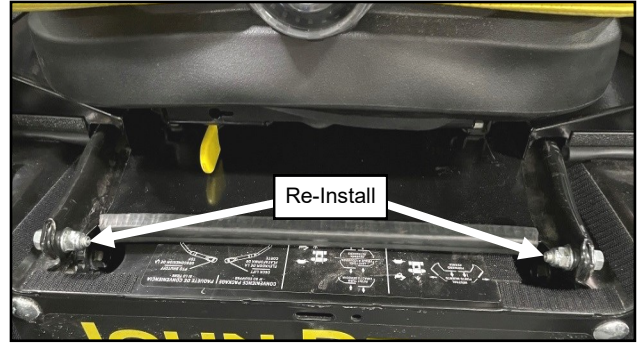

Fig. 1.28 (Re-Install Seat with Seat Pan)

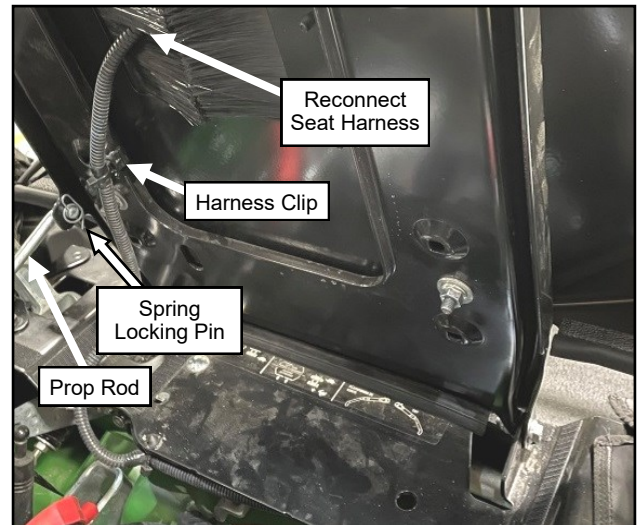

Fig. 1.29 (Reconnect Seat Connector & Prop Rod)

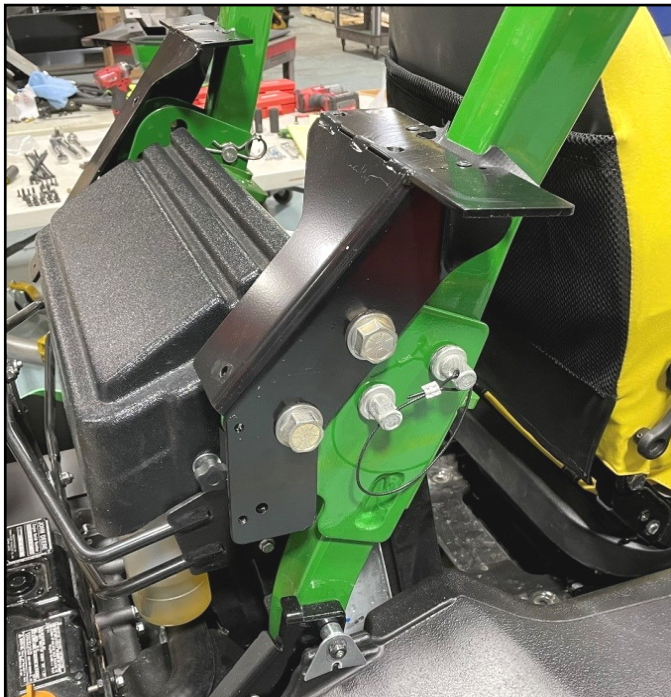

Fig. 1.30b (Install R.O.P.S bracket, right)



Fig. 1.30a (Install R.O.P.S bracket, left)



# CAB INSTALLATION

## STEP 1: (VEHICLE PREP CONT'D.)

**1.31** Remove compressor (with guard and tensioner) from the compressor and tensioner mounts and keep the three 3/8" screws and three 3/8" nuts with compressor. Support the compressor using a bungee cord or rope. Do not ever use the hoses to support the compressor or damage may occur. Next, remove compressor and tensioner mounts from rear shipping bracket and discard the three 5/16" screws and three 5/16" nuts. See Figure 1.31.

### Tools required

1/2" socket and wrench

9/16" socket or wrench

5/16" Allen wrench

**1.32** Disconnect the white wire connectors shown in Figure 1.32, and pull the harness out from behind the fuel hardlines.

**1.33** Re-route the wire harness between the fuel hardlines as shown in Figures 1.33a and 1.33b and reconnect the white connectors.

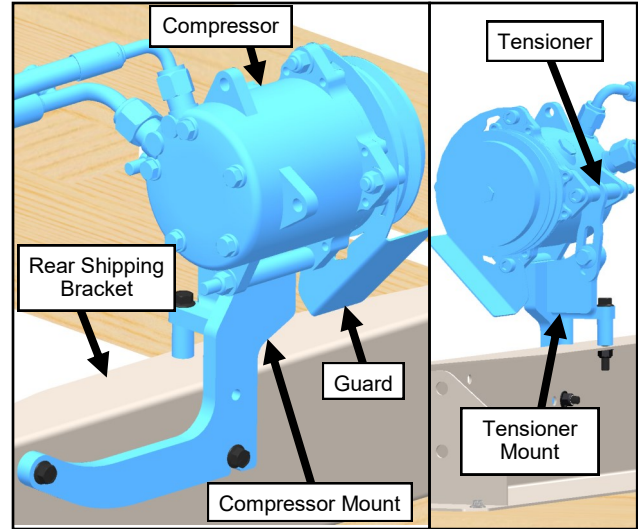

Fig. 1.31 (Remove Compressor Mount)

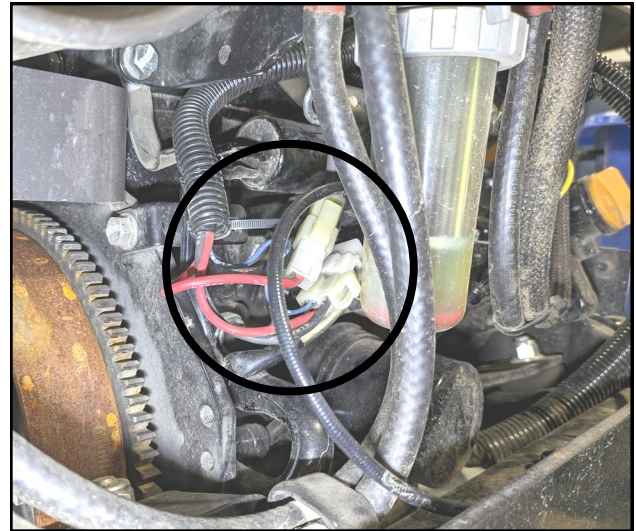

Fig. 1.32 (Disconnect White Connectors)

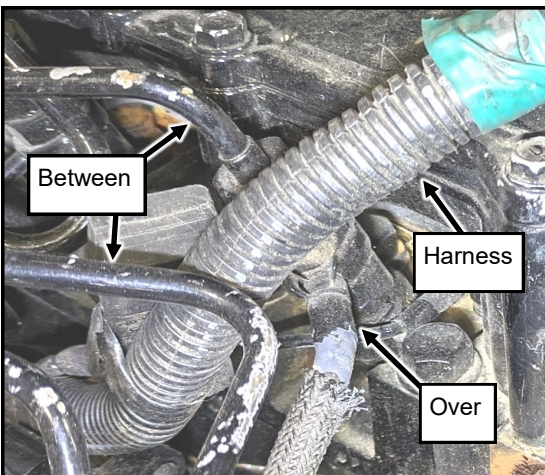

Fig. 1.33b (Route Wires)

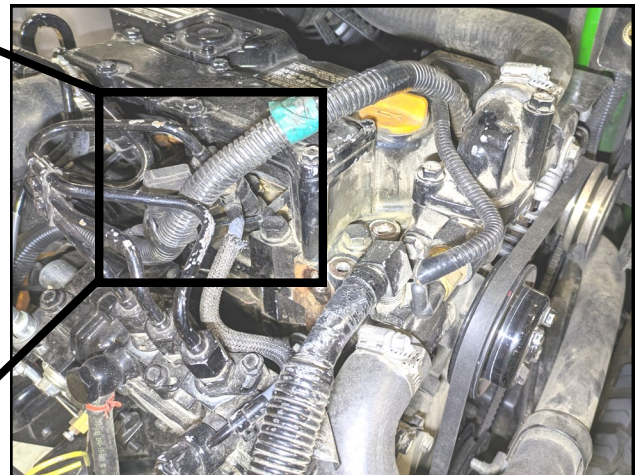

Fig. 1.33a (Route Wires)



# CAB INSTALLATION

## STEP 1: (VEHICLE PREP CONT'D.)

**1.34** Unwrap the loom tape next to the water temperature sensor wires. Move the exit point of the wires about 2" forward from where the dashed lines show in figure 1.34. Tape the wires in place and add the supplied wire loom.

**1.35** With a fender washer and supplied red Loctite, partially thread in an M8x1.25 x 25 hex screw into the lower hole shown in Figure 1.35. The screw and washer should be far enough out so the compressor bracket can slide on.

### Hardware Used

Hardware Used	Qty
M8x1.25 x 25 flanged hex screw	1
M8 fender washer (15/16" OD)	1

### Tools required

13mm wrench or socket

**1.36** Snake the compressor bracket arm between the hardlines and the engine and pivot down onto the previously installed screw. See Figure 1.36.

Ensure washer is under the head of the bolt and not between the bracket and engine block.

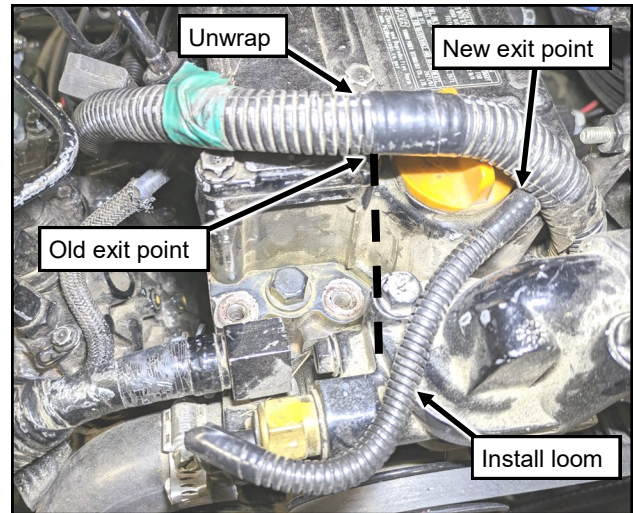

Fig. 1.34 (Move and wrap water temp. sensor wires)

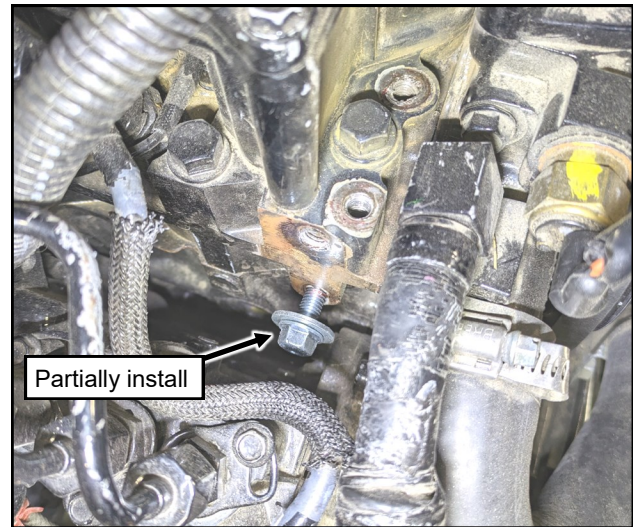

Fig. 1.35 (Partially thread in lower M8x25 screw)

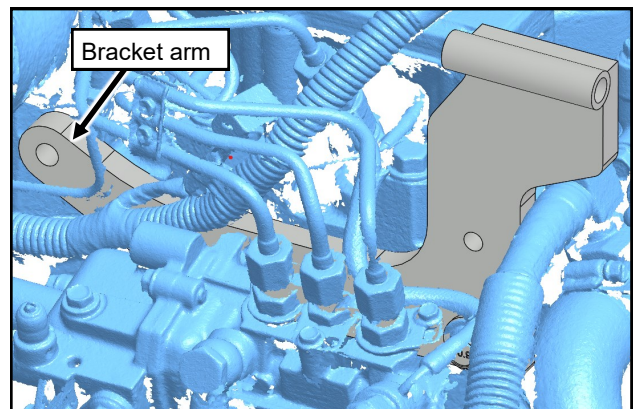

Fig. 1.36 (Snake compressor bracket into place)

# CAB INSTALLATION

## STEP 1: (VEHICLE PREP CONT'D.)

1.37 With a fender washer and supplied red Loctite, loosely thread in an M8x1.25 x 25 hex screw into the hole shown in Figure 1.37.

<u>Hardware Used</u>	<u>Qty</u>
M8x1.25 x 25 flanged hex screw	1
M8 fender washer (15/16" OD)	1

Tools required  
13mm wrench or socket

1.38 With a fender washer and supplied red Loctite, loosely thread in an M8x1.25 x 18 socket head screw into the hole shown in Figure 1.38.

<u>Hardware Used</u>	<u>Qty</u>
M8x1.25 x 18 socket head screw	1
M8 fender washer (15/16" OD)	1

Tools required  
6mm Allen wrench

1.39 With 5/16" washers and supplied red Loctite, loosely thread in two M8x1.25 x 50 hex screws into the tensioner mount holes shown in Figure 1.39.

<u>Hardware Used</u>	<u>Qty</u>
M8x1.25 x 50 flanged hex screws	2
5/16 washer (11/16" OD)	2

Tools required  
13mm wrench or socket

1.40 Torque all three screws on the compressor mount to 19 ft-lbs (26 N-M). Using a square, adjust the tensioner mount to be perpendicular to the compressor mount and torque the two tensioner mount screws to 19 ft-lbs (26 N-M). See Figure 1.4.

Tools required  
13mm wrench or socket  
6mm Allen wrench bit  
Torque Wrench  
Square

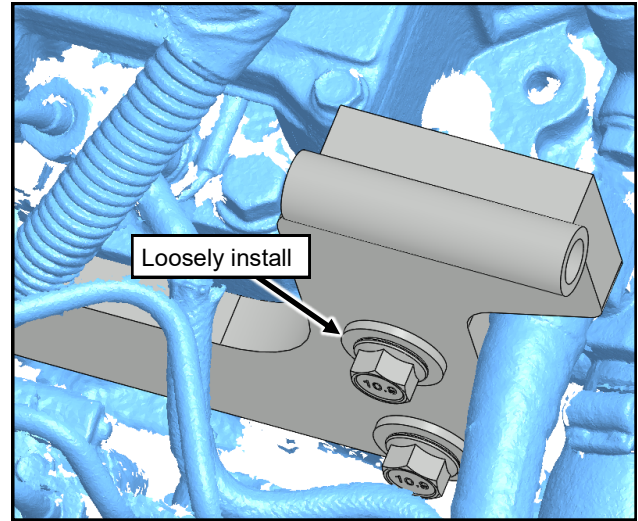

Fig. 1.37 (Loosely install second M8x1.25 x 25 screw)

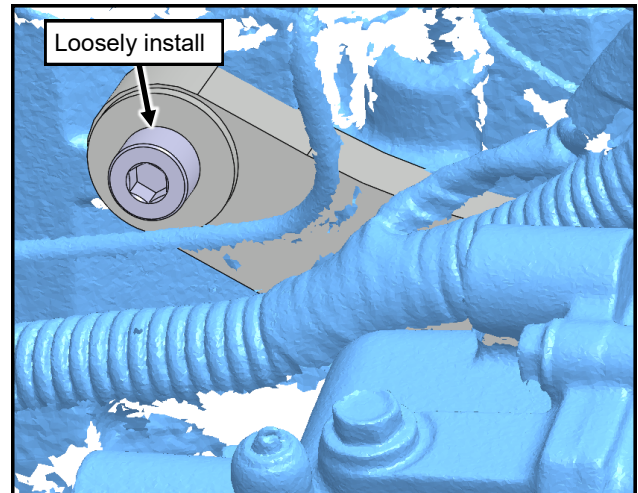

Fig. 1.38 (Loosely install M8x1.25 x 25 socket head screw)

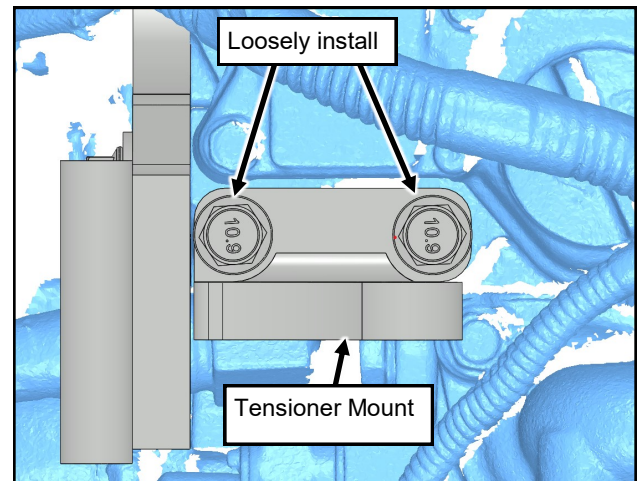

Fig. 1.39 (Loosely install M8x1.25 x 50 screws)

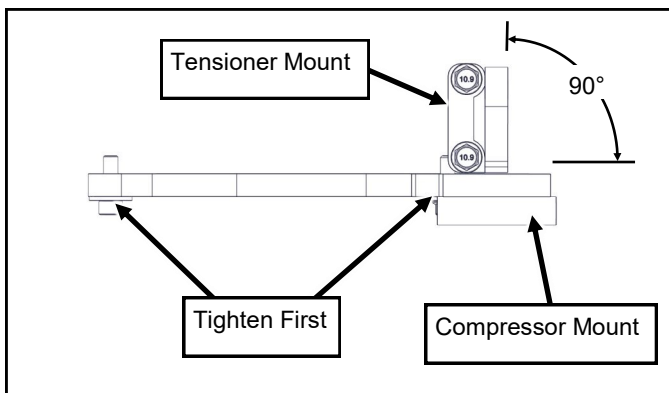

Fig. 1.4 (Torque Mounting Screws)



# CAB INSTALLATION

## STEP 1: (VEHICLE PREP CONT'D.)

1.41 Clean the vehicle frame rails on either side of the floorboard. Apply P.S.A. D-Rubber (9PR09) to the top surface of the frame rails. Apply along the inner edge of the surface as shown in Figure 1.41. Repeat for left side.

### Tools required

Scissors

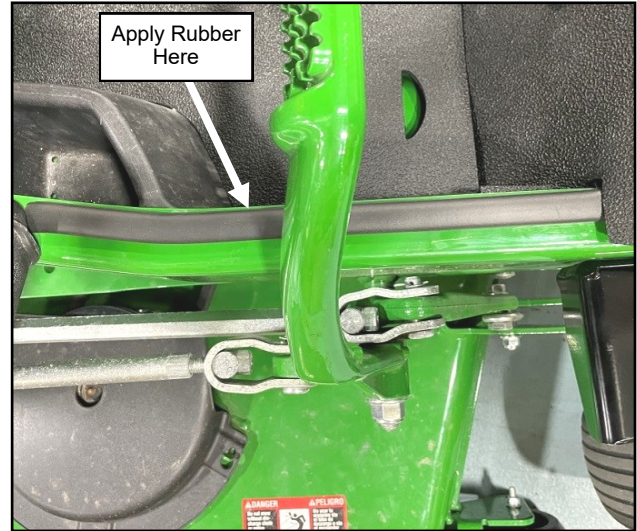

Fig. 1.41 (Install Rubber to Vehicle's Frame, Right)

# CAB INSTALLATION

## STEP 2: (CAB INSTALLATION)

- 2.1 Remove the doors from the cabin and set aside carefully to prevent scratching the panels.
- 2.2 Lower the mower deck to 2"
- 2.3 Position a lifting strap so that it sits roughly 7-1/2" behind the gas shock mount as shown in Figure 2.3.
- 2.4 Put tension on the lifting strap with the overhead hoist. Remove and discard the (4) bolts holding the rear of the cab down to the rear shipping bracket (located inside the cab) as well as the (4) bolts holding the floorboards to the front shipping brackets. See Figures 2.4a, b, and c.

### Tools required

1/2" wrench or socket

- 2.5 With assistance, lift the cabin and position over the vehicle. Be sure to support the A/C compressor so that it never hangs from the hoses.
- 2.6 Lower the cab slowly onto the vehicle being careful to not scratch the fenders with the rear edge of the floorboards.



Fig. 2.3 (Position Lifting Strap)

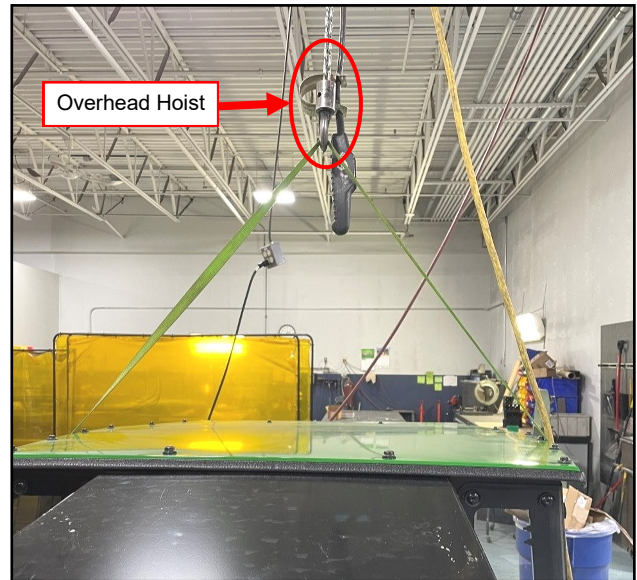

Fig. 2.4a (Tension Lifting Strap)

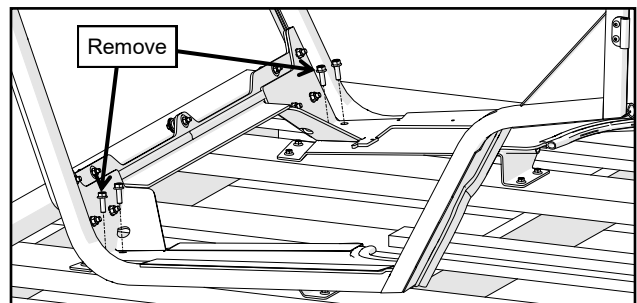

Fig. 2.4b (Remove Front Shipping Bracket Bolts)

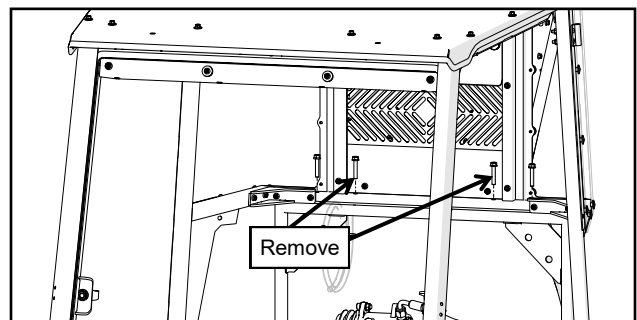

Fig. 2.4c (Remove Rear Shipping Bracket Bolts)



# CAB INSTALLATION

## STEP 2: (CAB INSTALLATION)

- 2.7 Install the back of the cab to R.O.P.S mounts per Figure 2.7.

<u>Hardware Used</u>	<u>Qty</u>
5/16-18X1-3/4" Flange Hex Screw	4
5/16-18 Flange Lock Nut	4

Tools required

1/2" wrench and socket

- 2.8 Install the front of the cab to front mounts per Figure 2.8.

<u>Hardware Used</u>	<u>Qty</u>
5/16-18X1" Flange Hex Screw	4
5/16-18 Flange Lock Nut	4

Tools required

1/2" wrench and socket

- 2.9 Fully tighten front mount hardware going into the vehicle's side frame. Torque to 110 ft-lbs. (150 Nm). See Figure 2.9.

Tools required

18mm wrench  
18mm socket  
Torque Wrench

- 2.10 Install one of the supplied brushes to the underside of the right cab floorboard.

Next, install a second brush along with the supplied floorboard insert on the inboard side of the deck lift lever. See Figure 2.10.

<u>Hardware Used</u>	<u>Qty</u>
#8-32 X5/8" Pan Head Screw	6
#8-32 Flange Lock Nut	6

Tools required

11/32" wrench or socket  
#2 Phillips bit or screw driver

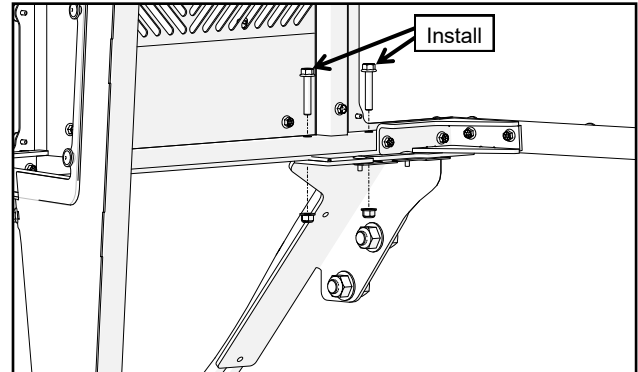

Fig. 2.7 (Install Back of Cab Screws)

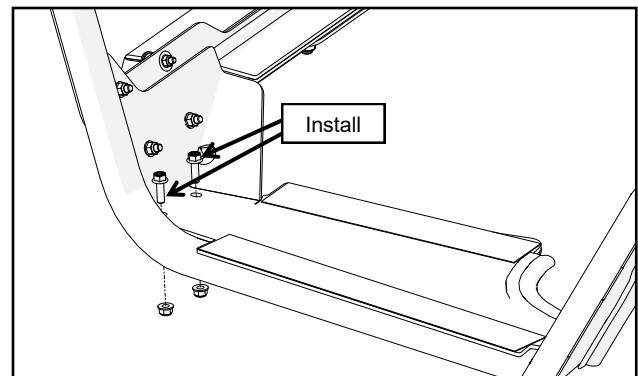

Fig. 2.8 (Install Front Mount Screws)

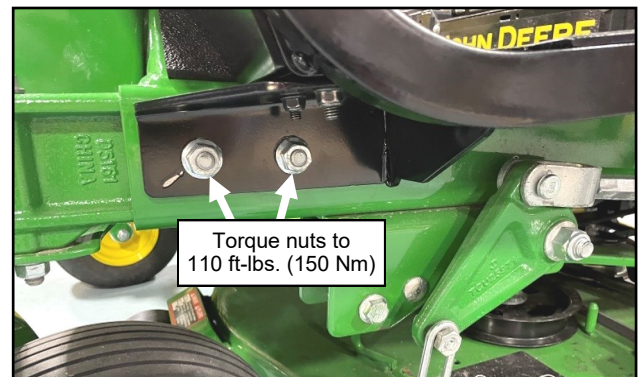

Fig. 2.9 (Tighten Vehicle Frame Bolts, Left)

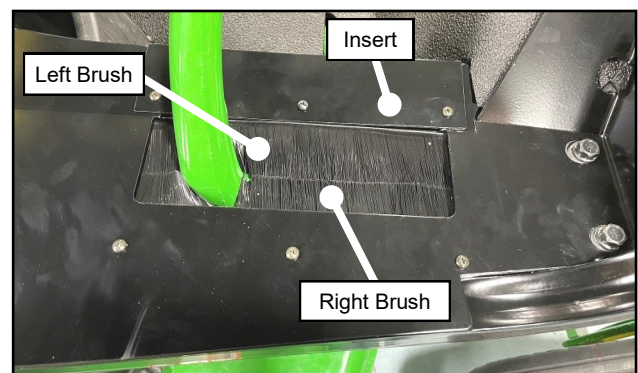

Fig. 2.10 (Install Brushes and Insert, Right)

# CAB INSTALLATION

## STEP 2: (CAB INSTALLATION)

**2.11** To install the compressor, run hoses from the left to right side of the vehicle over the engine. Install the preassembled compressor to the compressor and tensioner mounts. See Figures 2.11a and 2.11b. Leave hardware loose.

**Hardware Used**

	<b>Qty</b>
3/8-16 x 1-1/4" Flange Hex Screw	1
3/8-16 x 4-1/2" Socket Head Cap Screw	1
3/8-16 Flange Lock Nuts	2

**Tools required**

9/16" wrench and socket  
5/16" Allen wrench

**2.12** Install V-Belt onto the outer "V" groove of the compressor and install the other end onto the double pulley found on the alternator. See Figure 2.12.

**2.13** Tension belt by placing a straight edge tangent to compressor pulley and alternator pulley. Place belt tension tester in the center and perpendicular to the belt between the (2) pulleys and next to the straight edge. Push the tensioner towards the theoretical center making sure that a deflection force of 3.1 lbs. gets 0.2 inches of belt deflection at the center of the belt. See Figures 2.12 and 2.13. Tighten hardware and verify correct tension.

**Tools required**

9/16" wrench and socket  
5/16" Allen wrench  
Belt tensioner tester  
Straight edge

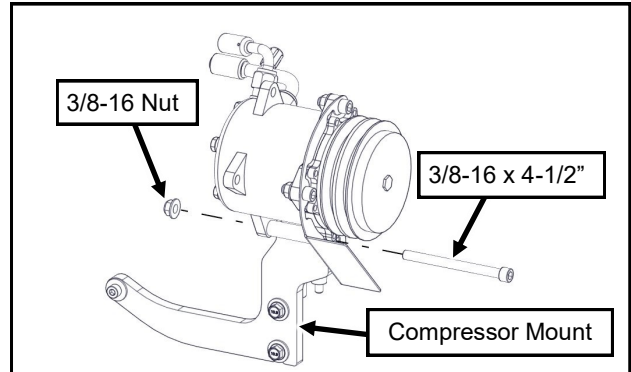

Fig. 2.11a (Install compressor)

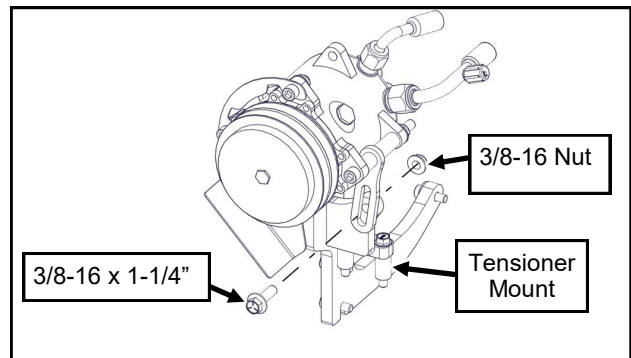

Fig. 2.11b (Install compressor)

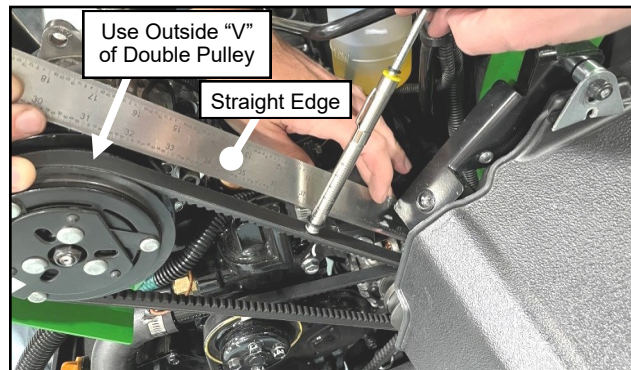

Fig. 2.12 (Install V-Belt)

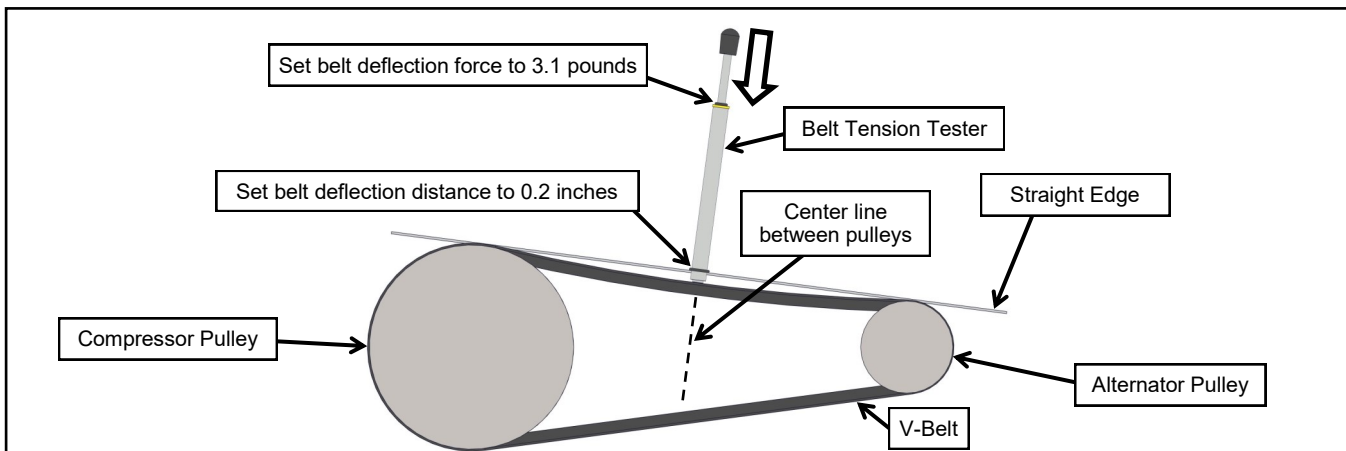

Fig. 2.13 (Tension Compressor V-Belt)

# CAB INSTALLATION

## STEP 2: (CAB INSTALLATION)

2.14 Slide the seat rearward then tilt seat forward.

2.15 Install right filler onto the cab from the outside using provided hardware per Figure 2.15. Note: side screws have lock nuts on the inside.

<u>Hardware Used</u>	<u>Qty</u>
5/16-18X3/4" Flange Hex Screw	4
5/16-18 Flange Lock Nut	2

Tools required  
1/2" wrench and socket

2.16 Install left filler onto the cab from the inside using provided hardware per Figures 2.16a and b.

<u>Hardware Used</u>	<u>Qty</u>
5/16-18X3/4" Flange Hex Screw	5

Tools required  
1/2" wrench and socket

2.17 Apply P.S.A. Velcro on the left fender up the left filler per Figure 2.17. Continue the Velcro on the lower edge of the window.

Tools required  
Scissors

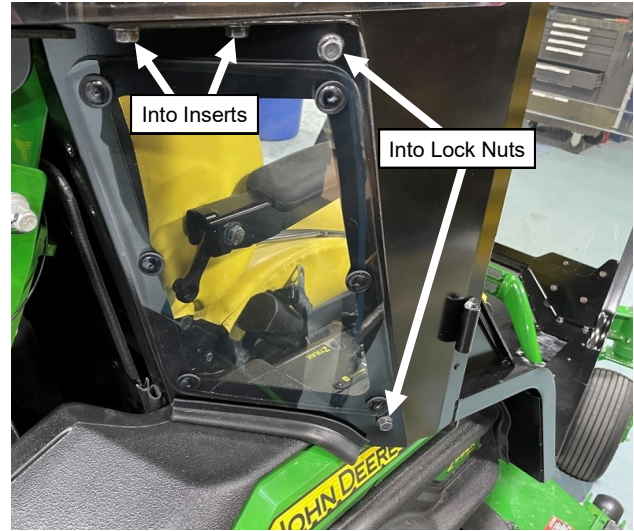

Fig. 2.15 (Install Right Filler)

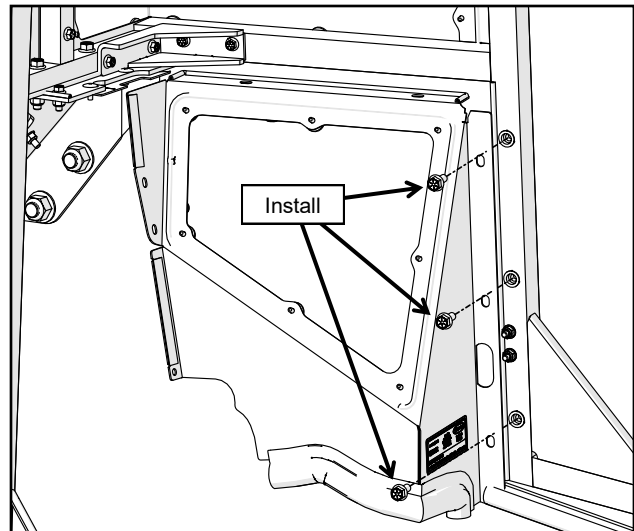

Fig. 2.16a (Install Left Filler, Inside View)

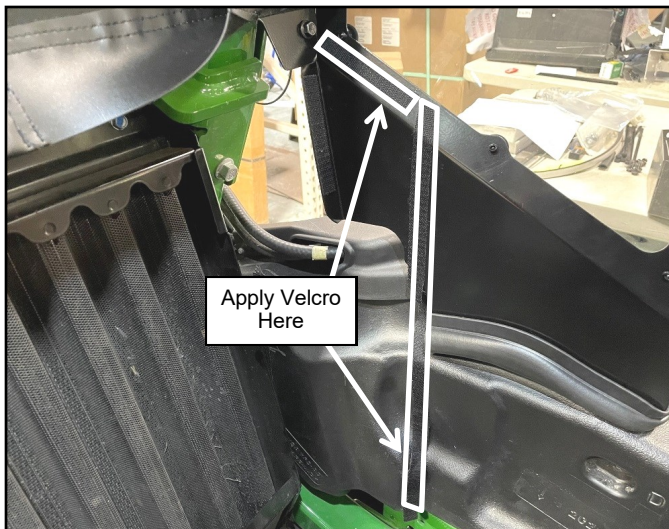

Fig. 2.17 (Apply Velcro to Left Filler and Fender)

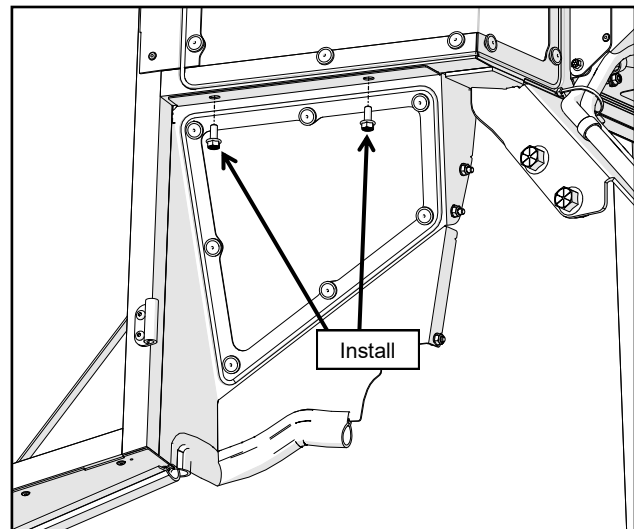

Fig. 2.16b (Install Left Filler, Outside View)



# CAB INSTALLATION

## STEP 2: (CAB INSTALLATION)

**2.18** Place the rear panel assembly onto the R.O.P.S. brackets. Apply pressure towards the AC Unit. Install the top horizontal screws first and then the (4) screws in two rear fillers. Attach to the previously installed Velcro. See Figure 2.18.

<u>Hardware Used</u>	<u>Qty</u>
1/4-20X5/8" Flange Hex Screw	4
1/4-20X3/4" Flange Hex Screw	2
1/4-20 Flange Lock Nut	6

### Tools required

3/8" wrench or socket  
7/16" wrench or socket

**2.19** At the bottom of the left side rear panel assembly, there is a small piece of Velcro. Place a piece of P.S.A. Velcro onto the rear fender as shown in Figure 2.19. Attach lower corner of rear panel vinyl onto installed Velcro.

### Tools required

Scissors

**2.20** Once the rear panel's vinyl filler is fully installed onto the mating Velcro, install hardware through the Vinyl into the (2) fillers. See Figures 2.20a and b. Do not over tighten or vinyl will be damaged.

<u>Hardware Used</u>	<u>Qty</u>
1/4-20X3/4" PH Truss Head Screw	2
1/4-20 Flange Lock Nut	2

### Tools required

#3 Phillips Head Screwdriver  
7/16" wrench or socket

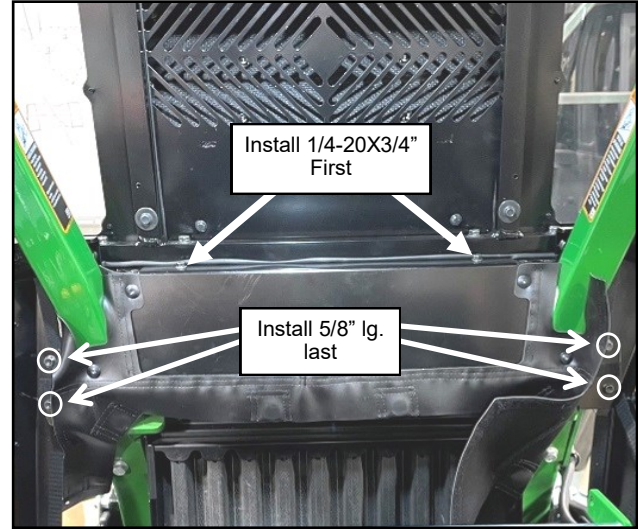

Fig. 2.18 (Install Rear Panel Assembly)



Fig. 2.19 (Install Velcro, Left Fender)

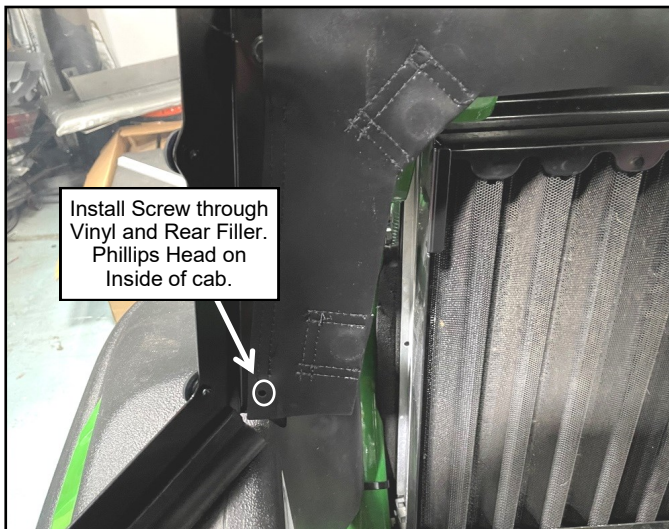

Fig. 2.20b (Attach Rear Filler Vinyl to Right Filler)

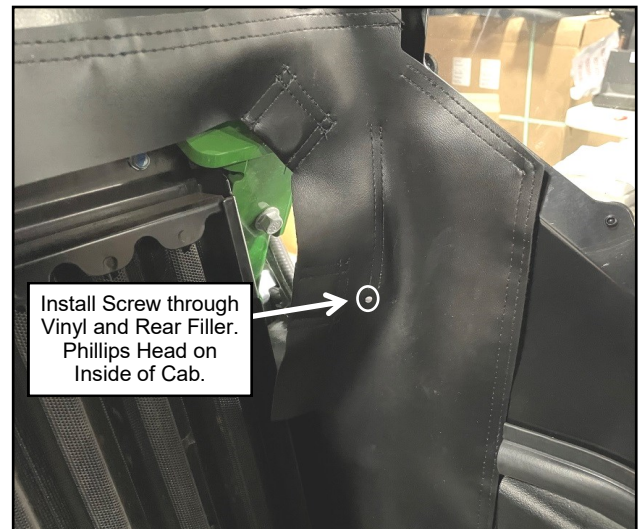

Fig. 2.20a (Attach Rear Filler Vinyl to Left Filler)



# CAB INSTALLATION

## STEP 2: (CAB INSTALLATION)

**2.21** Slide the supplied right hand drive handle boot down over the drive handles. (The right filler does not have the hole shown in Figure 2.22)

Press the sewn-on foam into the gap between the frame and fender and attach the boot to the pre-installed Velcro.

Move the drive handle forward and backwards as well as left to right to determine best spot for locating Velcro onto drive handles that will secure the top edge of the boot. Mark the top edge at the appropriate location. See Figure 2.21.

Slide the boot down the handle and apply Velcro around the handle below the mark.

Secure the top of the boot to the Velcro.

### Tools required

Scissors  
Marker

**2.22** Repeat installation for the left boot.

Slide the hole in the left boot over the head of the adjustment bolt as shown in Figure 2.22 upon installation.

### Tools required

Scissors  
Marker

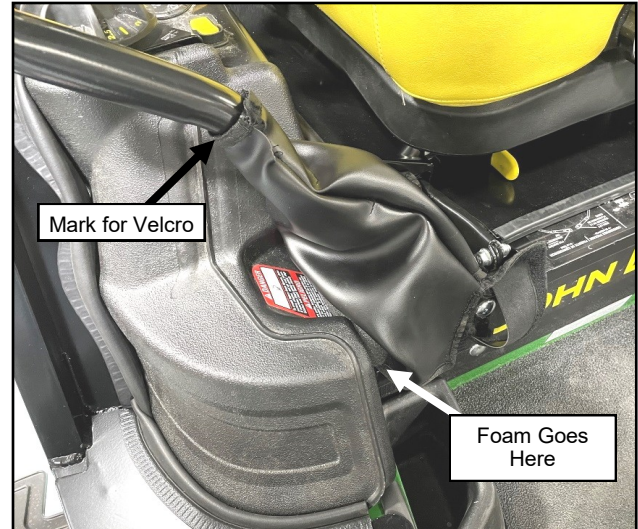

Fig. 2.21 (Loosely Install Drive Handle Filler, Right)

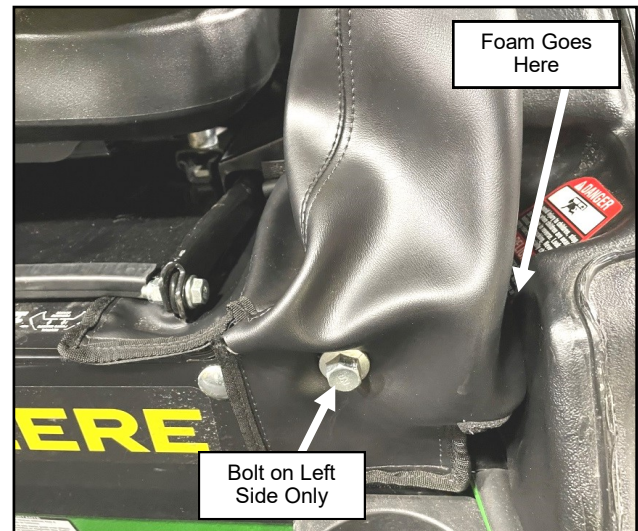

Fig. 2.22 (Install Left Filler, Outside)

# CAB INSTALLATION

## STEP 2: (CAB INSTALLATION)

**2.23** Remove the (2) clips found on the sides of the air cleaner mount and set aside. See Figure 2.23a. Rotate both the elbow that houses the "Air Restriction Indicator" as well as the body of the air cleaner in the mount roughly 180 degrees until it looks like Figure 2.23b.

### Tools required

Flat Head Screw Driver

**2.24** Per Figure 2.24, install relocation bracket making sure fender washers are placed between relocation bracket and vehicle's bracket.

### Hardware Used

Hardware Used	Qty
5/16-18X1" Flange Hex Screw	2
.349 X 1.129 Fender Washer	2
5/16-18 Flange Lock Nut	2

### Tools required

1/2" wrench and socket

**2.25** Re-install reconfigured air intake per Figure 2.25. Make sure air intake is pointed vertically. At that point, re-install clips into the air cleaner's mount removed on step 2.23. Fully tighten down hose clamps found on the engine and air cleaner. Make sure the extra part of the hose clamp located on the engine is pointing down away from the fuel lines. If radiator cover was removed on step 1.8, re-install now.

### Hardware Used

Use hardware set aside on step 1.8

### Tools required

13mm wrench and socket

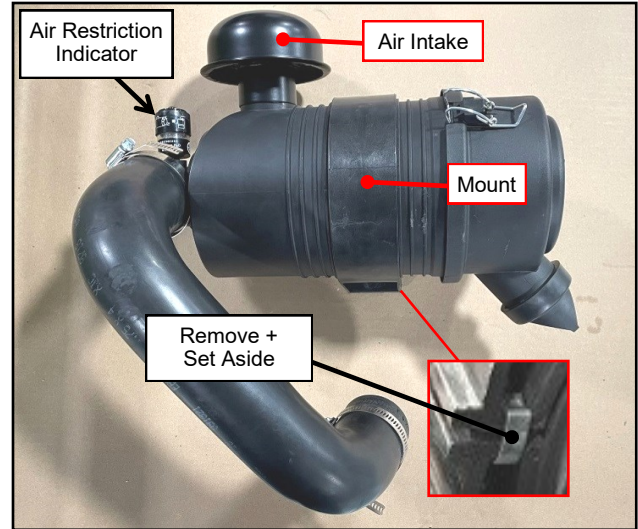

Fig. 2.23a (Reconfigure Air Cleaner, Stock)



Fig. 2.23b (Reconfigure Air Cleaner, New)

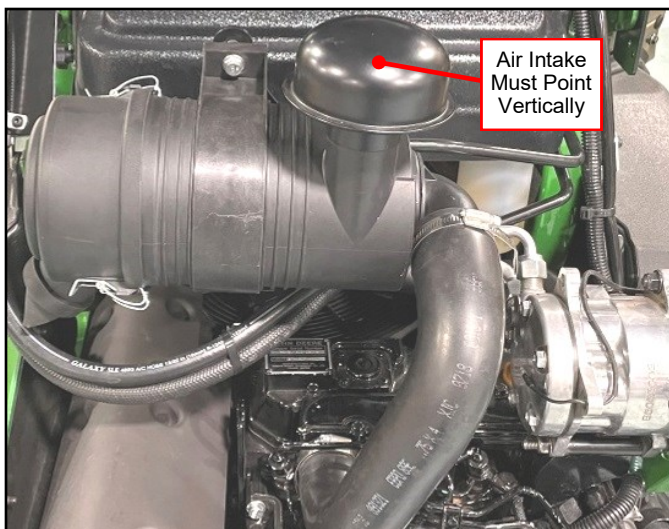

Fig. 2.25 (Install Reconfigured Air Cleaner)

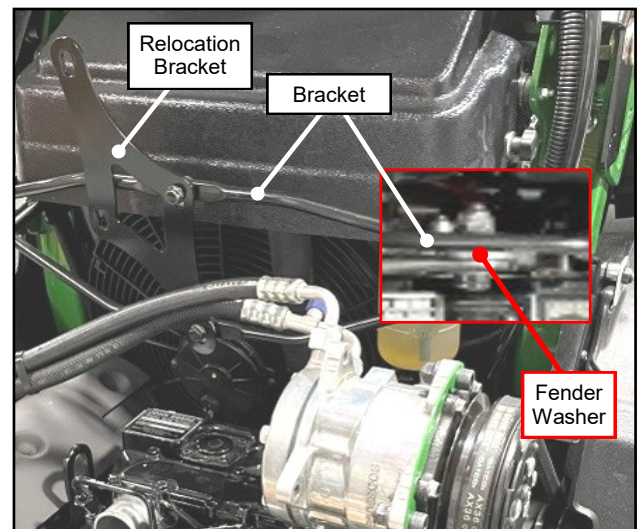

Fig. 2.24 (Install Relocation Bracket)



# CAB INSTALLATION

## STEP 2: (CAB INSTALLATION)

**2.26** Secure the larger AC hose and the wire harness to the ROPS brackets using p-clamps as shown in Figure 2.26.

Adjust hose and clamps so that the hoses are away from the hot muffler when p-clamps are tightened.

### Hardware Used

	Qty
1/4-20X1" Button Head Screw	3
1/4-20 Flange Lock Nut	3
3/4" P-Clamp	3
11" Heavy Duty Wire Ties	As Needed

### Tools required

5/32" allen wrench  
7/16" wrench or socket  
Angle Wire Cutters

**2.27** Run drain hose for AC Unit down in front of the alternator and out the bottom of the vehicle. Keep hose away from moving components and hot engine parts. See Figures 2.27a, b, and c for routing recommendations. Use provided Wire Ties as needed.

### Hardware Used

	Qty
11" Heavy Duty Wire Ties	As Needed

### Tools required

Angle Wire Cutters

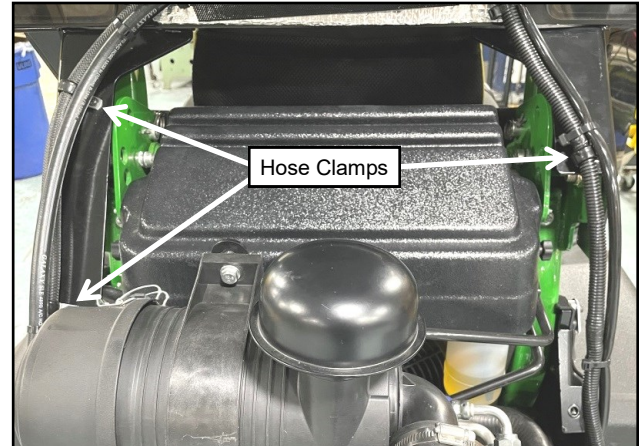

Fig. 2.26 (Install Hose Clamps on R.O.P.S Brackets)

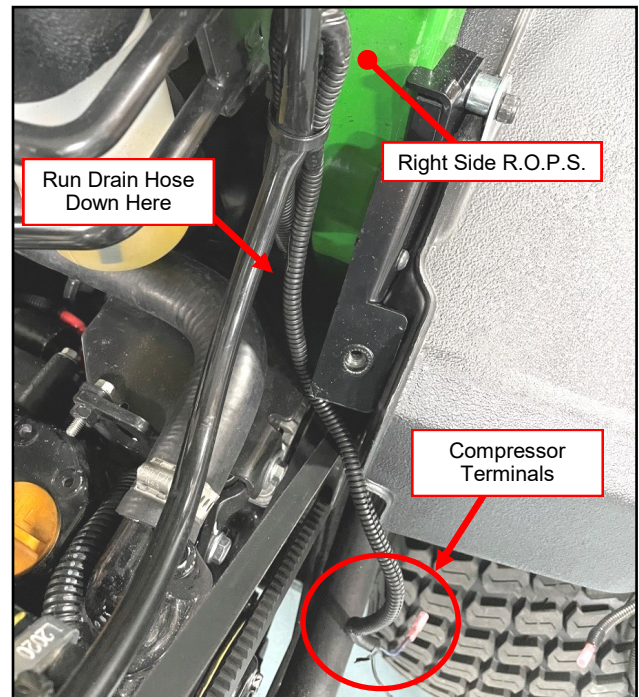

Fig. 2.27a (Routing Drain Hose)

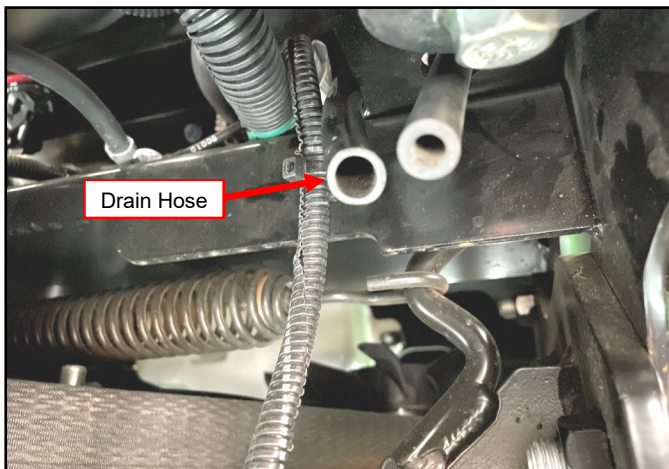

Fig. 2.27c (Drain Hose at Bottom of Vehicle)

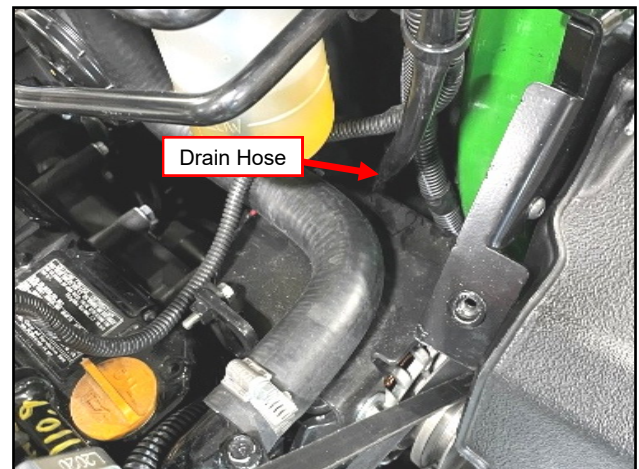

Fig. 2.27b (Drain Hose Between Radiator and R.O.P.S.)



# CAB INSTALLATION

## STEP 2: (CAB INSTALLATION)

**2.28** Per Figures 2.28a and b, run compressor part of the AC wire harness (ring and push-on terminals) to the compressor. Remove 3/8" Lock Nut and install ground ring terminal. Re-install 3/8" Lock Nut and connect the push-on terminal to terminal found on the compressor. Use supplied Wire Ties as need.

### Hardware Used

11" Heavy Duty Wire Ties

### Qty

As Needed

### Tools required

9/16" wrench or socket

5/16" allen wrench

Angle Wire Cutters

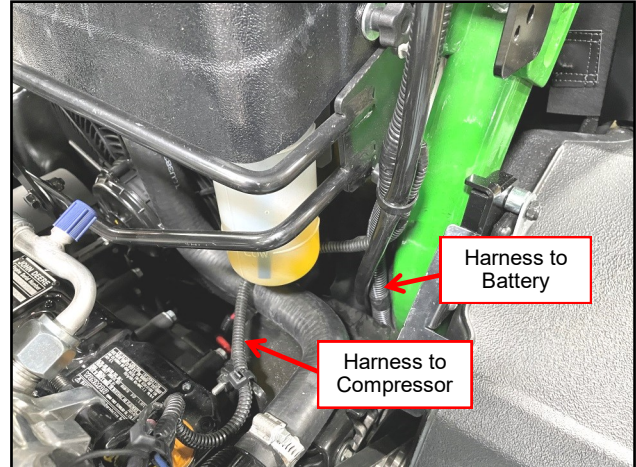

Fig. 2.28a (Routing AC Wire Harness)

**2.29** Pass the AC Wire Harness between the Radiator and right R.O.P.S as shown in Figure 2.28a. Continue to run the harness down the inside of the right fender. Connecting the harness' 2-pin connector to the vehicle harness per Figure 2.29. Use supplied Wire Ties as needed.

### Hardware Used

11" Heavy Duty Wire Ties

### Qty

As Needed

### Tools required

Angle Wire Cutters

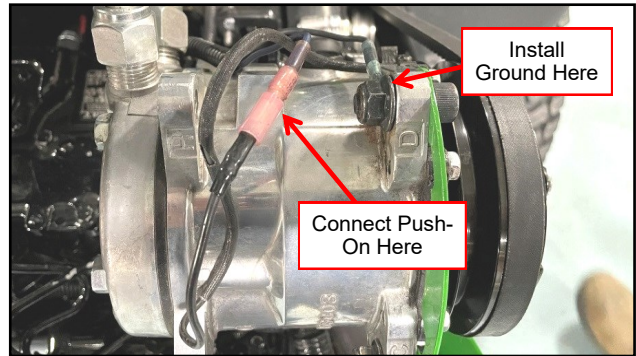

Fig. 2.28b (Connecting AC Harness to Compressor)

**2.30** Run the harness (fuse holder side) to the Positive Terminal on the Vehicle's battery per Figure 2.30a. Next, run the black wire ring terminal to the disconnected battery wire and install onto the ground lug. Reconnect lug onto the battery per Figure 2.30b.

### Hardware Used

11" Heavy Duty Wire Ties

### Qty

As Needed

### Tools required

1/2" wrench or socket

Angle Wire Cutters

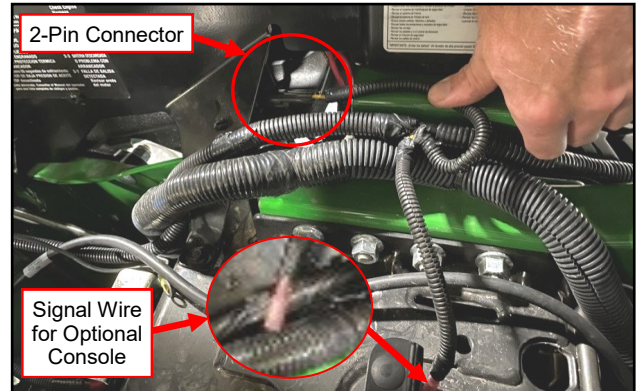

Fig. 2.29 (Run Harness on Inside of Right Fender)

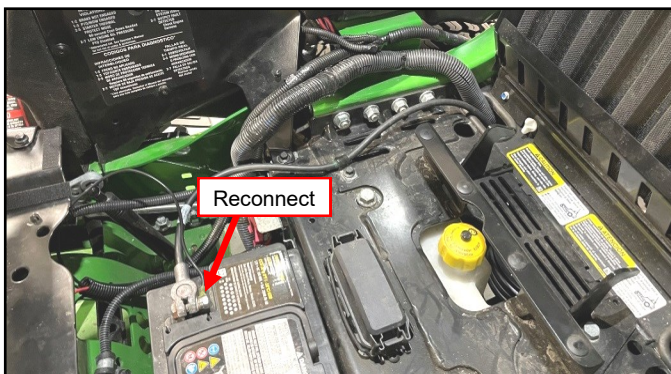

Fig. 2.30b (Run Harness to (-) Terminal on Battery)

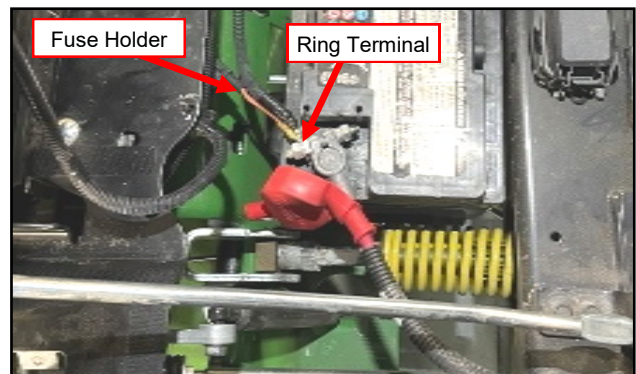

Fig. 2.30a (Run Harness to (+) Terminal on Battery)



# CAB INSTALLATION

## STEP 2: (CAB INSTALLATION)

**2.31** Re-install the modified grille using (2) screws removed on step 1.4 to secure the left side. See Figure 2.31.

### Hardware Used

Use hardware set aside on step 1.4

### Tools required

T25 Torx Bit

**2.32** Install Compressor Shroud onto right side of vehicle using (2) screws removed from step 1.4 and (1) 5/16-18 screw. See Figures 2.32a and b. Use the (3) holes found in the shroud as guides for drilling the grille shown on Figure 2.32a. Apply touch up paint to drilled holes.

### Hardware Used

5/16-18X3/4" Flange Hex Screw      **Qty**  
1

Use hardware set aside on step 1.4

### Tools required

T25 Torx Bit  
1/2" wrench or socket  
Center Drill  
9/32" Drill Bit  
Drill

**2.33** Per Figure 2.33, install hardware through shroud into grille.

### Hardware Used

1/4-20X5/8" Flange Hex Screw      **Qty**  
3

1/4-20 Flange Lock Nut              3

### Tools required

3/8" wrench or socket  
7/16" wrench or socket



Fig. 2.31 (Install Re-Worked Grille)

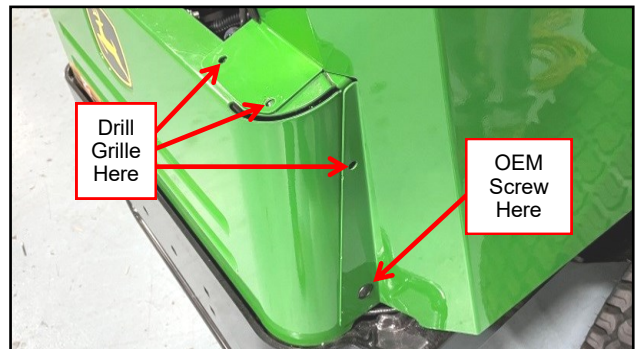

Fig. 2.32a (Rear Screws for Mounting Shroud)

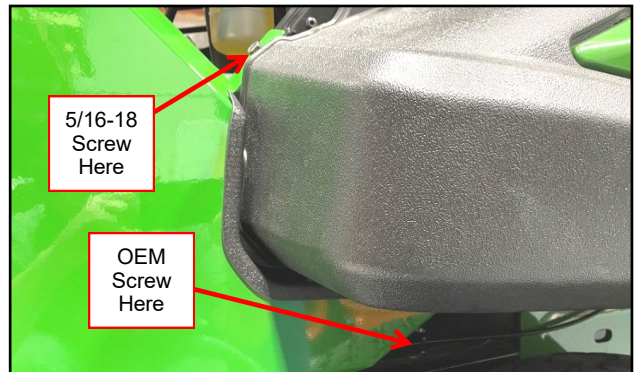

Fig. 2.32b (Front Screws for Mounting Shroud)



Fig. 2.33 (Install Hardware into Shroud)



# CAB INSTALLATION

## STEP 2: (CAB INSTALLATION)

**2.34** Per Figure 2.34, tighten hardware clamping the right fender. Making sure retainer sits in groove found in fender. Note: 5/16-18 screw may need to be adjusted so compressor shroud has proper fit with bracket.

### Tools required

13mm wrench and socket  
1/2" wrench or socket (if needed)

**2.35** Using a narrow plastic putty knife, push bulb rubber down in areas between the side frame and the vehicle's fender where gaps occur. If there are still gaps, cut 1/2" X 9/16" rubber foam (into 2" pieces) and install into any gaps that may be found between the left side of the cab and fender. On the right side, at the corner of the side frame and rear filler, as well as near the floorboard. Make sure to apply adhesive side onto the fenders of the vehicle. Per Figures 2.35a and b.

### Tools required

Scissors  
Narrow Plastic Putty Knife

**2.36** Per Figure 2.36a, re-install the left and right doors. Next, install gas shocks onto the doors and side frames as shown on figure 2.36b. Make sure rod side gas shock is on the door side.

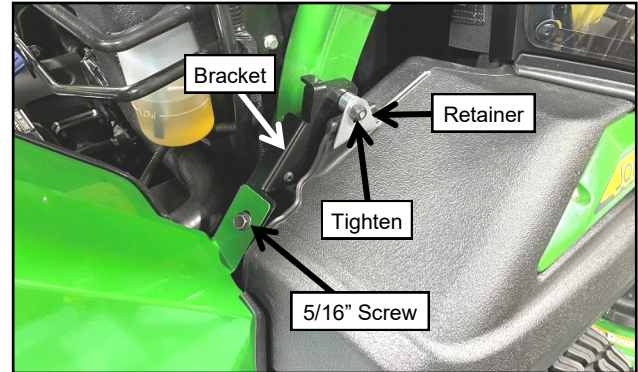

Fig. 2.34 (Tighten Hardware to Clamp Fender)

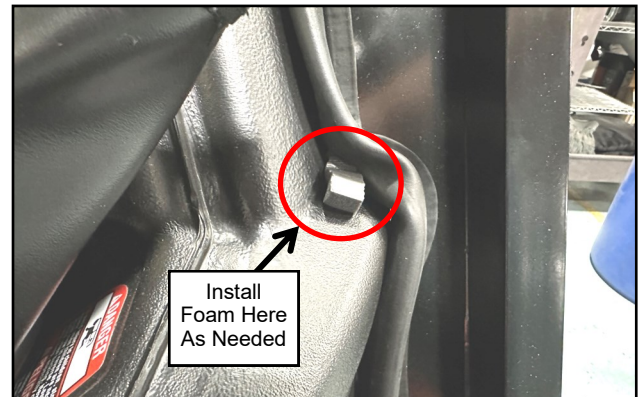

Fig. 2.35a (Install Foam on Left Fender)



Fig. 2.35b (Install Foam on Right Fender)

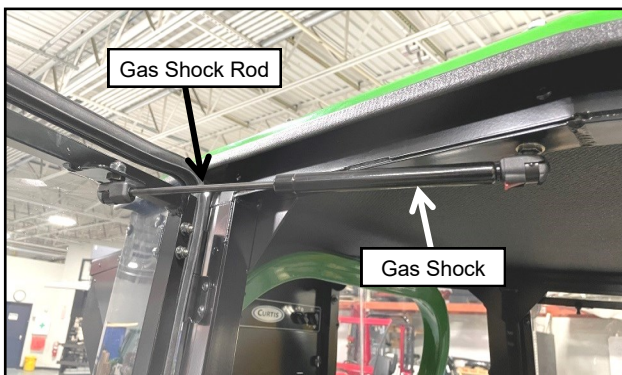

Fig. 2.36b (Install Door Gas Shock, Right)

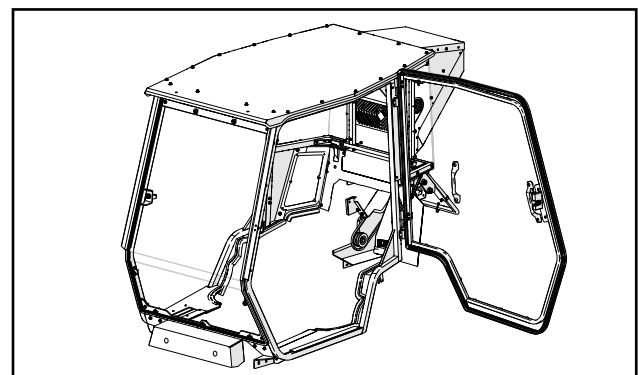

Fig. 2.36a (Re-Install Door, Left)

# CAB INSTALLATION

## STEP 2: (CAB INSTALLATION)

**2.37** Pre-install the supplied Velcro to the parking brake filler. Leave the release tape on until filler is in place.

### Tools required

Scissors

**2.38** Lower the mower deck. Clean the underside of the floor thoroughly in the vicinity of the parking brake. Block the mower rear wheels and release the parking brake.

**2.39** Position the filler in place under the floor and around the frame. Once confident of filler position, remove the release tape and attach the filler one piece at a time. Reference all photos on this page.

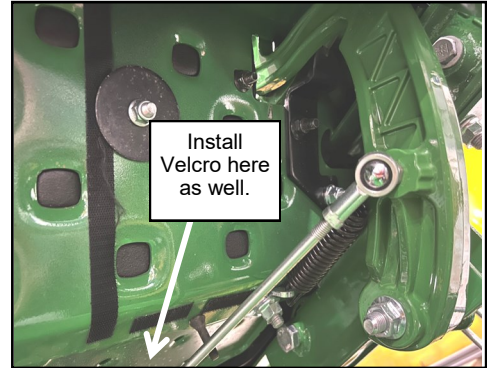

Fig. 2.39a (Under floor Velcro position)



Fig. 2.39b (Velcro on left frame)



Fig. 2.39c (Filler, Left)



Fig. 2.39e (Filler, Rear)

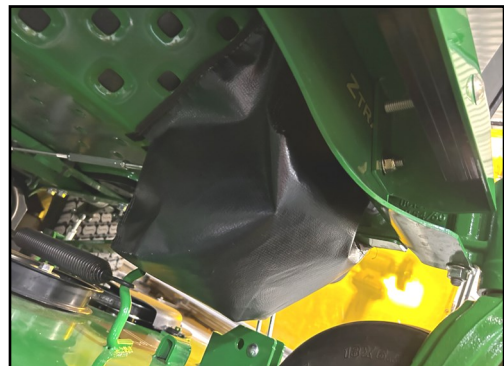

Fig. 2.39d (Filler, Right)



# CAB INSTALLATION

## STEP 2: (CAB INSTALLATION)

2.40 Lower the seat down.

2.41 Turn on vehicle and test operation of the A/C Unit. If the A/C Unit does not function properly, check out the "Troubleshooting" section of this manual. See Figure 2.38 for basic A/C operation.

2.42 Next, install any accessories purchased for this vehicle.

2.43 The cab installation is now complete.

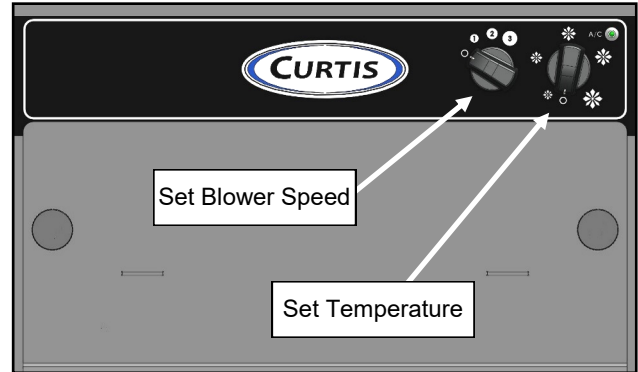

Fig. 2.41 (Test A/C Unit Functionality)

# CAB FEATURES & OPERATION

## AIR CONDITIONING OPERATION

See Figure 2.38 above. Turn the 4 -position ventilation switch to activate the blower. This can be used as just a blower with the A/C compressor turned off.

Rotate the A/C switch to the desired temperature setting to turn the compressor on/off.

In order for the A/C compressor to function, the vehicle throttle must be set at full speed.

The blower must be turned on in order for the A/C compressor to function.

## AIR FILTER CHECK

Remove the two thumbscrews on the face of the A/C and slide the drawer out to access the air filter.

Change the filter as needed based on operating conditions.

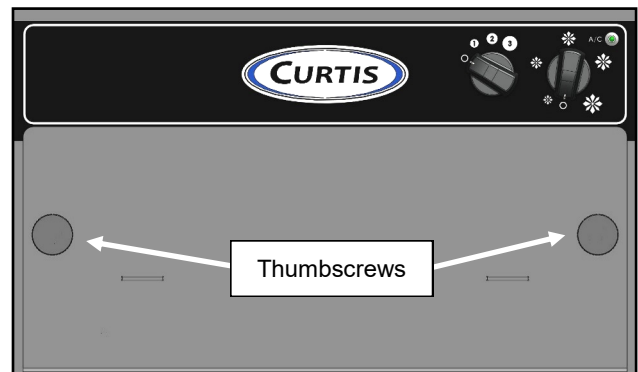

Air Filter Access

## CARE AND MAINTENANCE

- DO NOT use glass cleaner to clean windows. It will damage the material. Mild dish soap and water should be used to clean all window panels. Use a soft bristled brush or sponge to clean panels.
- Avoid wiping the windows while they are dry. Hose down with water to remove heavy debris before wiping windows. Water acts as a lubricant to help prevent scratches.
- Re-apply grease periodically as needed to the door striker pins, door latch assemblies, and the door hinges.
- Check the belt tension after the first 10 hours of use.
- Check and tighten hardware after 40 hours of operation. Periodically inspect and tighten hardware for the remainder of the unit's life. Check for any wearing or chaffing on hoses or wiring and correct as necessary.
- Wash the painted surfaces of the cab with commercial automotive cleaning products.
- Change cabin air filter as required depending on usage conditions.
- Inspect/clean the exterior of the condenser of all dust and debris daily.
- This product is designed with the use of R134a as a refrigerant. Never substitute other refrigerants, use of any other refrigerant will void warranty.
- Charge unit with 2.3 lbs. of R134a refrigerant.
- Apply vacuum for a minimum of 30 minutes prior to charging the air conditioner with R134a.
- Do not vent refrigerant to the atmosphere. If the unit has to be discharged for any reason, recover the refrigerant in compliance with federal, state, and local laws.
- Refrigerant Oil - use only ZEROL ESTER 68SL to replenish any oil lost during refrigerant recovery.
- Replace the drier receiver (9SV-9AC-00003) when replacing a compressor (9SV-9AC-00006).

## TROUBLESHOOTING

- Check all electrical connections to ensure that proper connections are made and terminals are all tight.
- Check Battery Condition:  
Resting/No Load Voltage should be 12.35V or greater.  
Terminals should be clean and tight.
- Check all fuses:  
30 amp fuse located at battery  
15 amp fuse located near relays, located inside the air conditioner (accessible with filter drawer removed).
- Check both relays. Located inside the air conditioner (accessible with filter drawer removed).
- Check the tension of the OEM and secondary drive v-belts





# JOHN DEERE Z994R SERVICE PARTS

PULLEY, DOUBLE, 34 DEG V-BELT  
P/N: 9SV-MP-00077

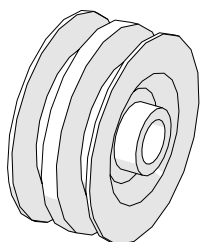

MNT BRACKET ASS'Y, COMPRESSOR  
P/N: 8SV-113-00316

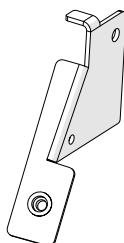

SPACER, RIGHT FENDER  
P/N: 8SV-SM-02425

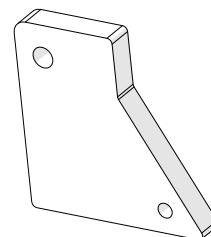

MOUNT BRACKET, FB, LEFT  
P/N: 8SV-SM-02455-L

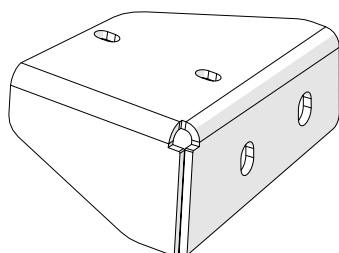

MOUNT BRACKET, FB, RIGHT  
P/N: 8SV-SM-02455-R

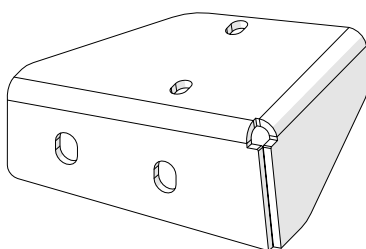

BACKING PLATE, BALLAST BOX  
P/N: 8SV-SM-02478

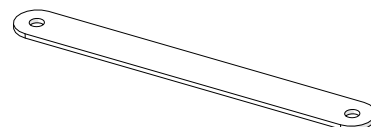

BALLAST BOX W/ WEIGHTS  
P/N: 8SV-113-00326

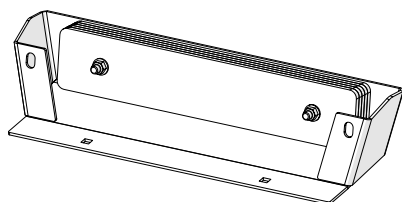

FLOOR MAT, FOOTREST LIP  
P/N: 8SV-9FR-00090

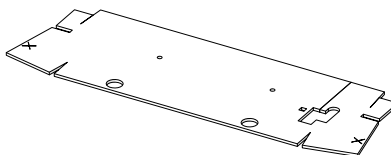

FLOOR MAT, FOOTREST  
P/N: 8SV-9FR-00089

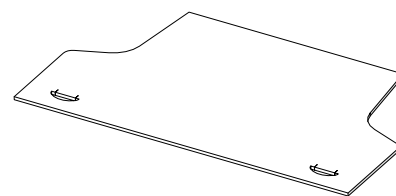

CLIPPED WASHER, 3/8" X 1-1/4"  
P/N: 8SV-SM-02548

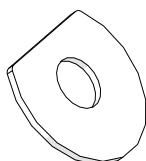

ARM RESTRICTOR BRKT ASS'Y, L  
P/N: 8SV-113-00320-L

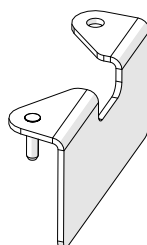

ARM RESTRICTOR BRKT ASS'Y, R  
P/N: 8SV-113-00320-R

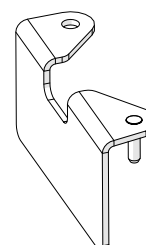



# JOHN DEERE Z994R SERVICE PARTS

SEAT PAN ASSEMBLY  
P/N: 8SV-113-00314

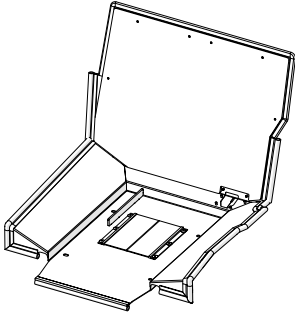

LEVER, SEAT RELEASE  
P/N: 8SV-SM-02391

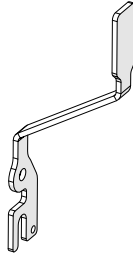

ROPS MOUNT ASSEMBLY, LEFT  
P/N: 8SV-110-00118-L

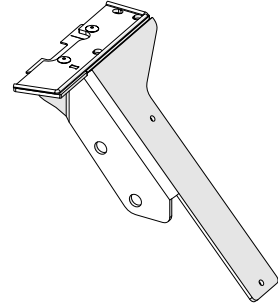

ROPS MOUNT ASSEMBLY, RIGHT  
P/N: 8SV-110-00118-R

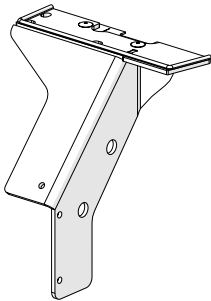

WELDMENT, COMP. MOUNT  
P/N: 8SV-WA-00767-ZC

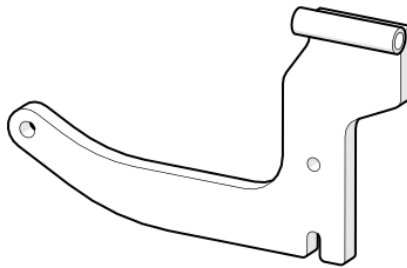

TENSIONER MOUNT  
P/N: 8SV-MP-00115-ZC

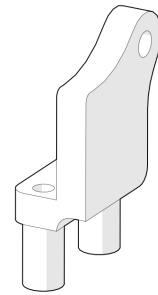

A/C COMPRESSOR  
P/N: 8SV-9AC-00048-A

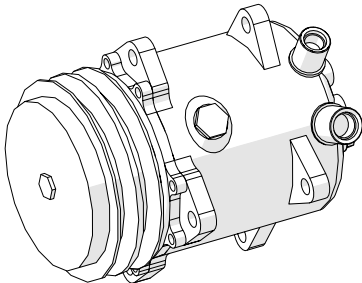

GUARD, BELT  
P/N: 8SV-SM-02435

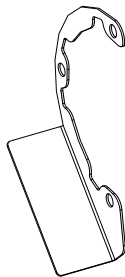

TENSIONER  
P/N: 8SV-WA-00772-ZC

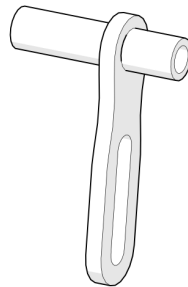

FLEX BRUSH, 1.6" X .012" X 9" (PAIR)  
P/N: 8SV-9SL-00021

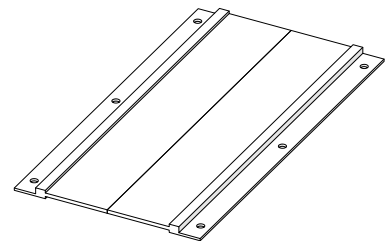

FLOORBOARD FILLER  
P/N: 8SV-SM-02458

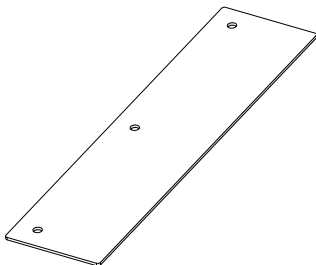

V-BELT  
P/N: 9SV-9BLT-16

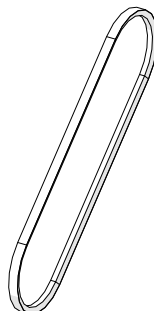

REAR FILLER, LEFT  
P/N: 8SV-111-00046-L

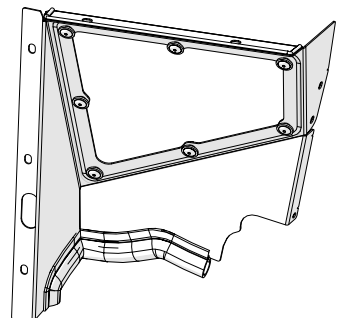

# JOHN DEERE Z994R SERVICE PARTS

WIRE HARNESS, A/C  
P/N: 9SV-WH-00147

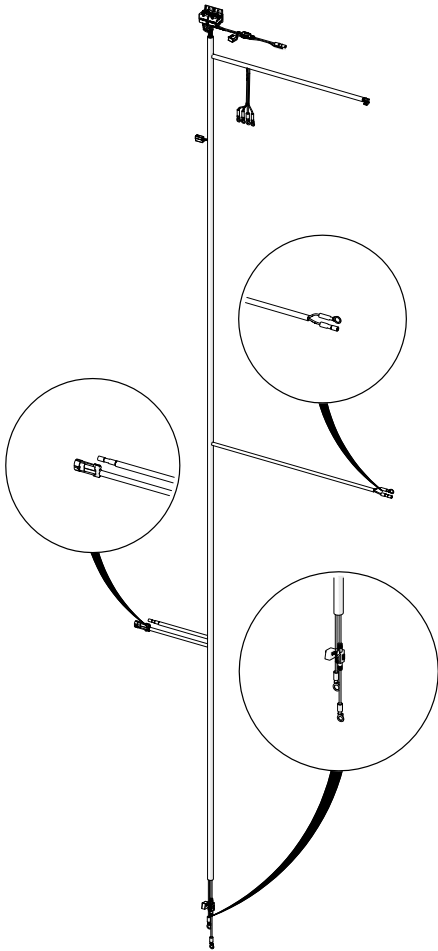

REAR FILLER, RIGHT  
P/N: 8SV-111-00046-R

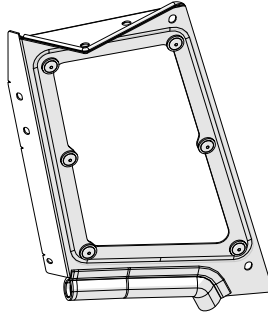

REAR PANEL ASSEMBLY  
P/N: 8SV-106-00047

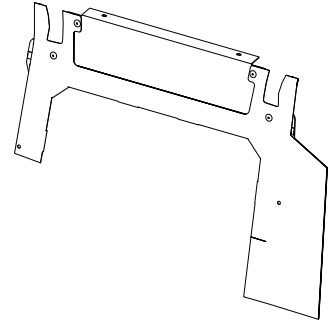

DRIVE HANDLE FILLER ASSY (1L, 1R)  
W/ VELCRO; P/N: 8SV-112-00082

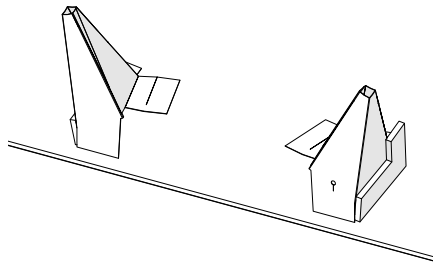

AIR FILTER RELOCATION BRACKET  
P/N: 8SV-SM-02318

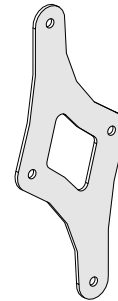

COVER ASSY, SIDE, COMPRESSOR  
P/N: 8SV-113-00315

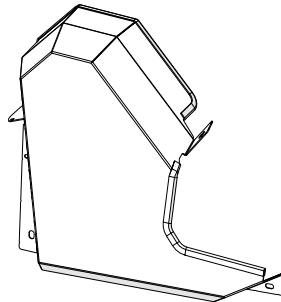

A/C UNIT, REAR MOUNTED, BLACK  
P/N: 8SV-301-00006-BP

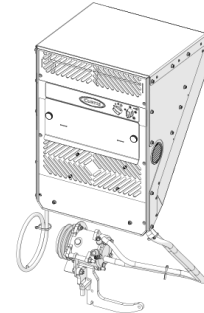

COVER ASSEMBLY, A/C,  
BLACK  
P/N: 8SV-303-00013-BP

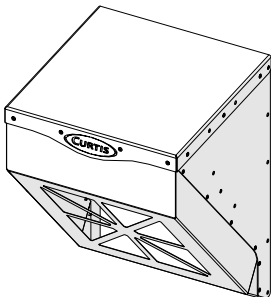

CONDENSER, PLENUM & FAN,  
BLACK  
P/N: 8SV-304-00027-BP

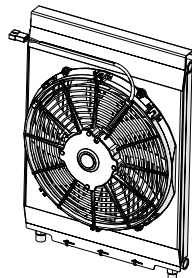

PARKING BRAKE FILLER  
P/N: 8SV-112-00095

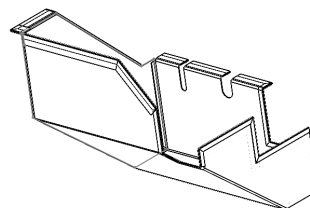

CONDENSER SUPPORT  
ASSEMBLY, BLACK  
P/N: 8SV-304-00029-BP

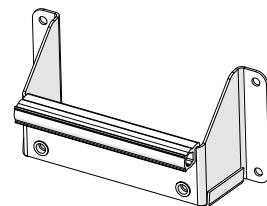



# JOHN DEERE Z994R SERVICE PARTS

CONDENSER CLAMP ASSEMBLY, A/C,  
SIDE, BLACK; P/N: 8SV-304-00030-BP

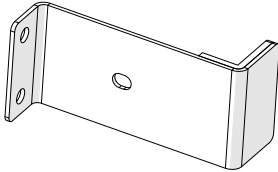

CONDENSER CLAMP ASSEMBLY, A/C,  
BOTTOM, BLACK; P/N: 8SV-304-00031-BP

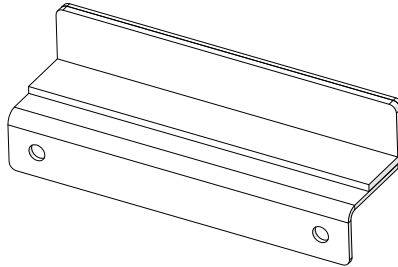

HOSE, #8, COMP TO COND  
P/N: 8SV-305-00022

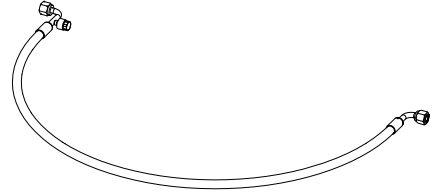

HOSE, #6, DRIER TO EVAP  
P/N: 8SV-305-00023

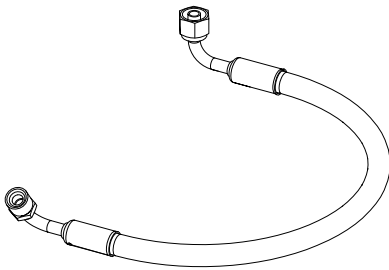

HOSE, #10 EVAP TO COMP  
P/N: 8SV-305-00024

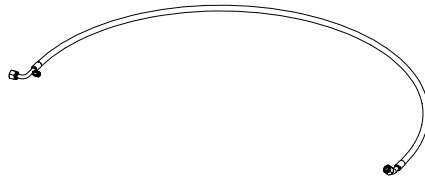

HOSE, #6, COND TO DRYER  
P/N: 8SV-305-00025

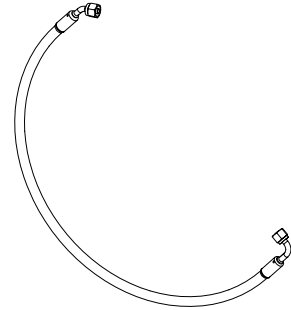

AIR FILTER  
P/N: 9SV-9HR-00032

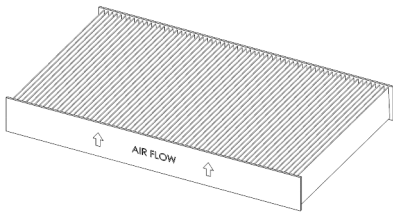

EVAPORATOR  
P/N: 8SV-9AC-00046

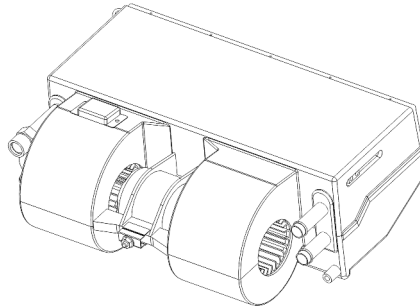

LOUVERED PLUG WITH FILTER  
P/N: 9SV-9DP25

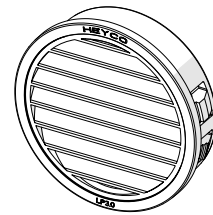

KNOB  
P/N: 9SV-OHC-27

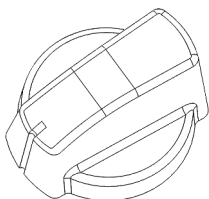

DIVERTER FLAP ASSEMBLY, A/C  
P/N: 8SV-113-00258-BP

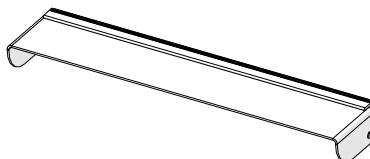

REAR MOUNT FRAME ASSEMBLY  
P/N: 8SV-113-00323

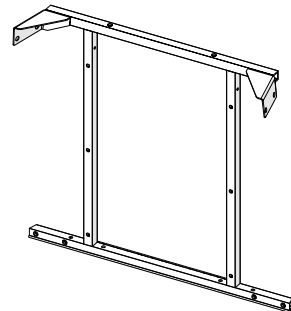

# JOHN DEERE Z994R SERVICE PARTS

ROOF ASSEMBLY  
P/N: 8SV-101-00067

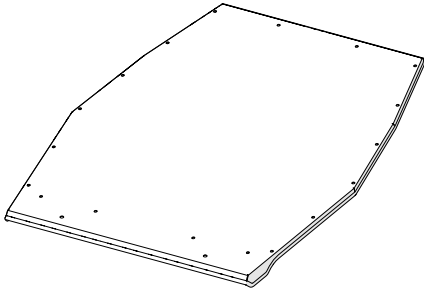

WINDSHIELD ASSEMBLY  
P/N: 8SV-102-00041

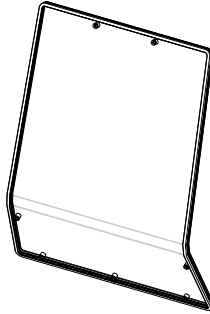

WINDSHIELD SUPPORT ASSEMBLY  
P/N: 8SV-103-00031

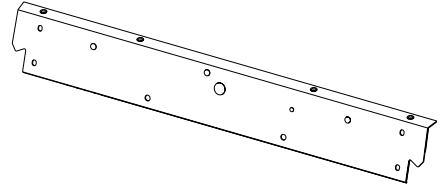

SIDE FRAME ASSEMBLY, RIGHT  
P/N: 8SV-109-00028-R

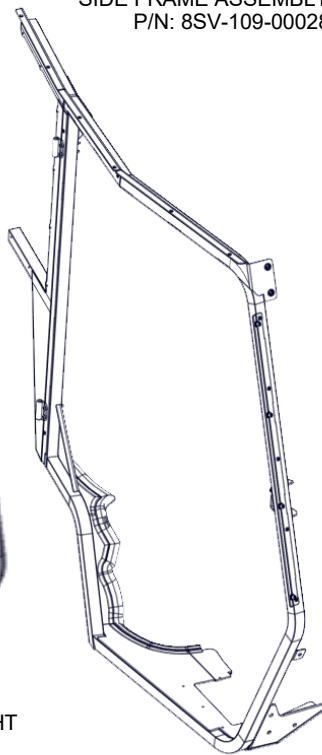

SIDE FRAME ASSEMBLY, LEFT  
P/N: 8SV-109-00028-L

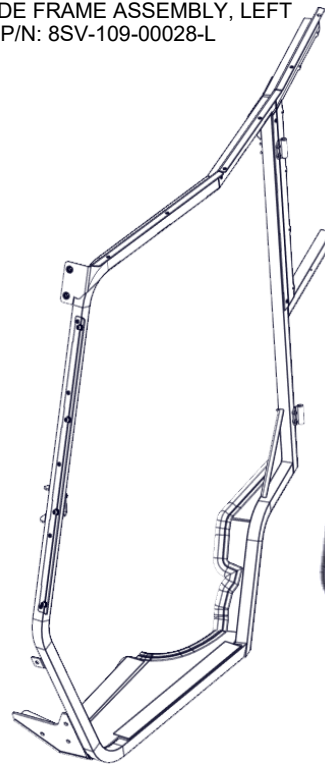

DOOR ASSEMBLY, RIGHT  
P/N: 8SV-107-00060-R



DOOR ASSEMBLY, LEFT  
P/N: 8SV-107-00060-L

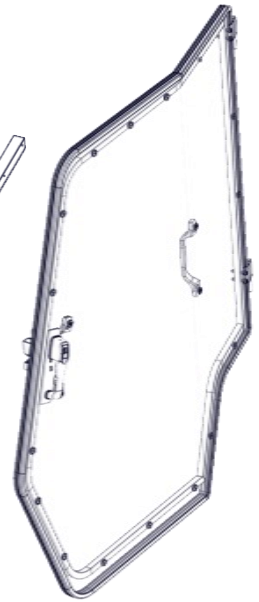

REAR LEG, LEFT, W/ HARDWARE  
P/N: 8SV-108-00030-L

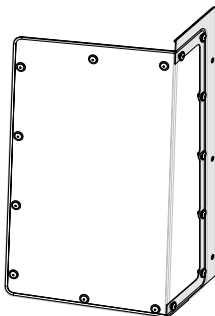

REAR LEG, RIGHT, W/ HARDWARE  
P/N: 8SV-108-00030-R

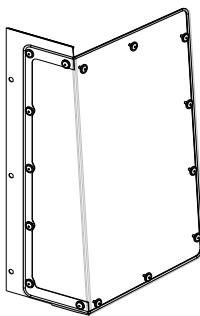

REAR LEFT FILLER WINDOW, W/  
HARWARE + RUBBER; P/N: 8SV-P-00168

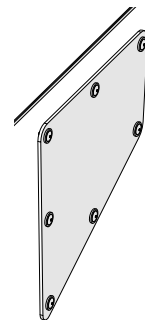



# JOHN DEERE Z994R SERVICE PARTS

REAR RIGHT FILLER WINDOW, W/  
HARWARE + RUBBER; P/N: 8SV-P-00169

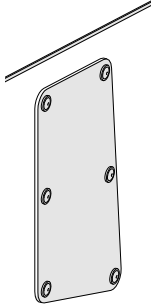

WELDMENT, LOWER BRACE, LEFT  
P/N: 8SV-WA-00574-L

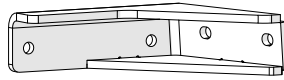

WELDMENT, LOWER BRACE, RIGHT  
P/N: 8SV-WA-00574-R

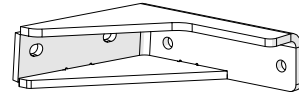

WINDSHIELD SUPPORT, LOWER  
P/N: 8SV-SM-02454

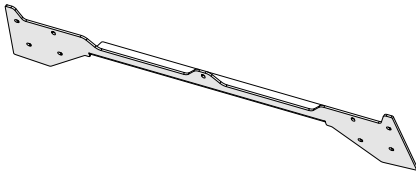

DOOR SKIN, RIGHT, W/ HARDWARE  
P/N: 9SV-P-00167-R

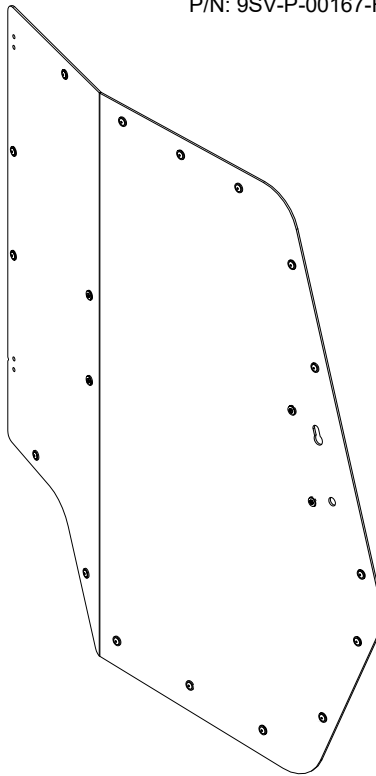

A-PILLAR CLAMP, UPPER, LEFT  
P/N: 8SV-SM-02361-L

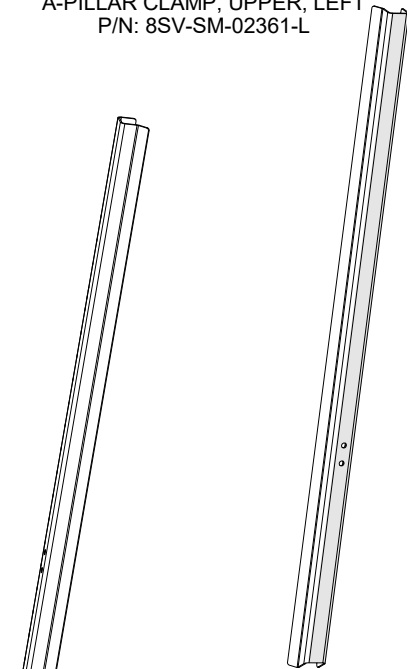

A-PILLAR CLAMP, UPPER, RIGHT  
P/N: 8SV-SM-02361-R

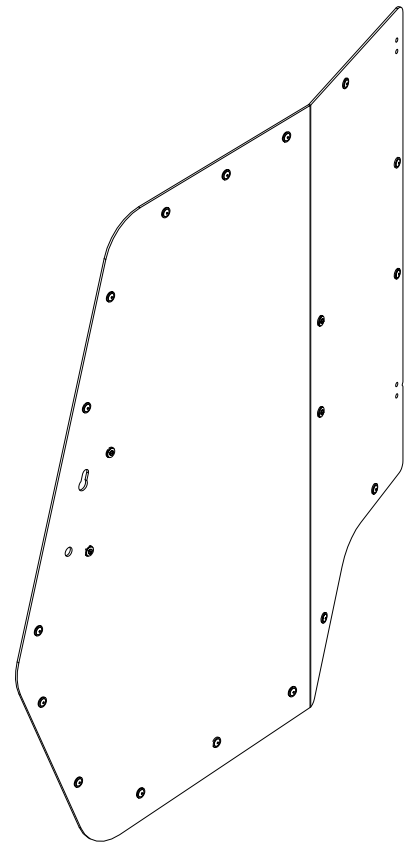

DOOR SKIN, LEFT, W/ HARDWARE  
P/N: 9SV-P-00167-L

## ADDITIONAL SERVICE PARTS

PART NUMBER	DESCRIPTION
9SV-HWK-00182	HARDWARE KIT, JDZ994
9SV-OHRL-G	OUTSIDE DOOR HANDLE (SET OF 2)
9SV-GH	INTERIOR GRAB HANDLE (SET OF 2)
9SV-HSLP	HINGE PINS AND SLEEVES (2L + 2R)
9SV-DP10	DOME PLUG, .375" HOLE (BAG OF 10)
9SV-DP16	DOME PLUG, .750" HOLE (BAG OF 4)
9SV-DP04	DOME PLUG, 1.125" HOLE (BAG OF 15)
9SV-9OR-01	O-RINGS, (INCL 1 OF EA: .301" ID .426" ID .551" ID)
9SV-GS02A	BALL STUD 10MM (BAG OF 10)
9SV-DL06S	INTERIOR DOOR LATCH W/COVER (1L +1R)
9SV-9AC-00001	CONDENSER
9SV-85-01-0022	RELAY, 12V, 20/40A, SPDT, MINI ISO
9SV-9AC-00003	DRIER RECEIVER
9SV-9AC-00005	PRESSURE SWITCH, 2-28KG/CM2
9SV-9AC-00007	AXIAL FAN FOR CONDENSER
9SV-DSTRH	DOOR STRIKER PIN (BAG OF 5)
9SV-GS02Q	GAS SHOCK 12-3/8" (SET OF 2)
9SV-9AC-00046-BS	BLOWER SWITCH
9SV-9AC-00046-TS	THERMOSTAT SWITCH
9DL01H	KEYS, SET OF 2 ON A RING, FOR HANDLE 1096-1, KEY CODE C40

TRIM LOK, STD,  
1/16" - 1/8" GRIP



9SV-PRO1-20

3/4" OVAL BULB  
WITH 3/16" GRIP



9SV-PR52-10

5/8" STD BULB,  
1/16" GRIP



9SV-PRO2-15

1/2" X 9/16"  
RUBBER FOAM



9SV-PR43-4

ARCH RUBBER  
P.S.A.



9SV-PRO9-10

3/4" SIDE BULB,  
1/4" GRIP



9SV-PR38-15

ARCH PSA,  
.20" X.15"

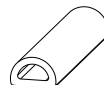

9SV-PR53-15

1" ROUND BULB,  
1/16" GRIP



9SV-PR19-10

1/2"  
WEATHERSEAL



9SV-PR20-10



# Torque Specs. for Structural Bolts

This page is for use primarily when dealing with high-strength vehicle fasteners such as ROPS hardware that hold the structure together for safety. This page can also be used for other solid metal-to-metal joints. **Do not** use these high torque values on any of the following applications involving: tubing, plastic, nylon or rubber washers, threaded inserts, etc.. See next page regarding less critical fasteners.

The values below apply to fasteners that are dry or lubricated with normal engine oil. They do not apply if special graphited or moly disulphide greases or other extreme pressure lubricants are used. This applies to both UNF and UNC threads.

Remember to always use the same grade or property class when replacing bolts.

**IMPORTANT: on all PLATED GRADE 8 bolts, reduce torque 15% from listed bolt torque specification.**

SAE Grade No.		2				5				8*				
Bolt head identification mark as per grade. NOTE: Manufacturing Marks Will Vary														
		TORQUE		TORQUE		TORQUE		TORQUE		TORQUE		TORQUE		
Bolt Size	Inches	Millimeters	Pounds Feet		Newton-Meters		Pounds Feet		Newton-Meters		Pounds Feet		Newton-Meters	
			Min.	Max.	Min.	Max.	Min.	Max.	Min.	Max.	Min.	Max.	Min.	Max.
1/4	6.35	5	6	7	8	9	11	12	15	12	15	16	20	
5/16	7.94	10	12	14	16	17	20.5	23	28	24	29	33	39	
3/8	9.53	20	23	27	31	35	42	48	57	45	54	61	73	
7/16	11.11	30	35	41	47	54	64	73	87	70	84	95	114	
1/2	12.70	45	52	61	70	80	96	109	130	110	132	149	179	
9/16	14.29	65	75	88	102	110	132	149	179	160	192	217	260	
5/8	15.88	95	105	129	142	150	180	203	244	220	264	298	358	
3/4	19.05	150	185	203	251	270	324	366	439	380	456	515	618	
7/8	22.23	160	200	217	271	400	480	542	651	600	720	814	976	
1	25.40	250	300	339	406	580	696	787	944	900	1080	1220	1464	
1-1/8	25.58	-	-	-	-	800	880	1085	1193	1280	1440	1736	1953	
1-1/4	31.75	-	-	-	-	1120	1240	1519	1681	1820	2000	2468	2712	
1-3/8	34.93	-	-	-	-	1460	1680	1980	2278	2380	2720	3227	3688	
1-1/2	38.10	-	-	-	-	1940	2200	2631	2983	3160	3560	4285	4827	

\*Thick Nuts must be used with Grade 8 bolts

## METRIC BOLT TORQUE SPECIFICATIONS



Size of Screw	Property Class	Course Thread			Fine Thread		
		Pitch (mm)	Pounds Feet	Newton-Meters	Pitch (mm)	Pounds Feet	Newton-Meters
M6	5.6	1.0	3.6-5.8	4.9-7.9	-	-	-
	8.8		5.8-9.4	7.9-12.7		-	-
	10.9		7.2-10	9.8-13.6		-	-
M8	5.6	1.25	7.2-14	9.8-19	1.0	12-17	16.3-23
	8.8		17-22	23-29.8		19-27	25.7-36.6
	10.9		20-26	27.1-35.2		22-31	29.8-42
M10	5.6	1.5	20-25	27.1-33.9	1.25	20-29	27.1-39.3
	8.8		34-40	46.1-54.2		35-47	47.4-63.7
	10.9		38-46	51.5-62.3		40-52	54.2-70.5
M12	5.6	1.75	28-34	37.9-46.1	1.25	31-41	42-55.6
	8.8		51-59	69.1-79.9		55-68	75.9-92.1
	10.9		57-66	77.2-89.4		62-75	84-101.6
M14	5.6	2.0	49-56	66.4-75.9	1.5	52-64	70.5-86.7
	8.8		81-93	109.8-126		90-106	122-143.6
	10.9		96-109	130.1-147.7		107-124	145-168
M16	5.6	2.0	67-77	90.8-104.3	1.5	69-83	93.6-112.5
	8.8		116-130	157.2-176.2		120-138	162.6-187
	10.9		129-145	174.8-196.5		140-158	189.7-214.1
M18	5.6	2.0	88-100	119.2-136	1.5	100-117	136-158.5
	8.8		150-168	203.3-227.6		177-199	239.8-269.6
	10.9		175-194	237.1-262.9		202-231	273.7-313
M20	5.6	2.5	108-130	146.3-176.2	1.5	132-150	178.9-203.3
	8.8		186-205	252-277.8		206-242	279.1-327.9
	10.9		213-249	288.6-337.4		246-289	333.3-391.6

## Tightening of Non-Structural Bolts

For light or medium duty fastening, Curtis recommends using a general industry standard of tightening until snug and then giving an additional one quarter turn of the tool as deemed reasonable for the application (i.e.: at the installer's discretion).

If torque values are required, the examples listed below are intended as a reasonable reference for use in the majority of non-structural fastener applications such as: small diameter fasteners; bolts passing thru tubing, glass, plastic, nylon or rubber washers, threaded inserts, etc.

If more than one application below applies, use the lower torque value.

FASTENER SIZE:	FASTENER TYPE:	WASHER MATERIAL:	APPLICATION:	TORQUE (INCH-POUNDS) (±5)
#10	Machine Screws	-	in Nylon P-Clamps	20
#10	Machine Screws	-	Strobe Light (plastic base)	35
M5	Set Screws	-	Wiper Arm	20
1/4"	Cap Nut	-	Windshield Wiper	20
1/4"	Bolts	-	Tubing (5/8" to 3/4" wide)	132
1/4"	Bolts	Rubber	-	60
1/4"	Bolts	Nylon / Plastic	-	72
1/4"	Bolts	-	Factory Installed Threaded Inserts	132
5/16"	Bolts	-	Tubing (1" or wider)	60
5/16"	Flat Head Bolts	-	Plastic Windshield Hinge	79
5/16"	Bolts	Rubber	-	120
5/16"	Bolts	Nylon / Plastic	-	150
5/16"	Ball Studs	-	-	150
5/16"	Bolts	-	Factory Installed Threaded Inserts	240
3/8"	Bolts	-	Tubing	120
M12	Door Striker Pins	-	-	120