



Kubota ZD1211
(p/n: 1KUBZD1211PR3)
 Cab with A/C
 (fits both 60" and 72" mowers)
 (Does not fit with bagger system)

While this cab kit was designed to fit on the vehicle listed above, manufacturing tolerances and vehicle assembly may affect cab fitment. It is the responsibility of the cab installer to check all vehicle pedals and levers for full functionality and, as required, adjust the cab fitment to prevent any interference of the cab components with the travel of pedals or levers.



Premium Cab Shown with Options

Available Options:

1. Side View Mirrors (P/N: 9PM5)
2. Switch Panel (P/N: 1KUBZD1211CK) (req'd for following 2 items)
3. Front LED Work Lights (P/N: 1KUBZD1211LK)
4. Front Wiper/Washer Kit (P/N: 1KUBZD1211WK)

Approximate Installation Time *
Experienced Dealer Technician – 4 Hours
Average Dealer Technician – 6 Hours
Do-It-Yourself – 6-8 Hours

Approximate Product Specifications
Floorboard to Roof Height: 60 inches
Weight: 240 lbs.
Cab Width: 54 inches

(*=Not including accessories)

Register your new product quickly online at Curtiscab.com/product-registration/



Curtis encourages all customers to register their Curtis products. However, failure to do so will not diminish right to warranty. Curtis Industries does not sell or share your information with anyone else.

Download a digital copy of your installation instructions online at Curtiscab.com/literature/



Curtis strives to continuously improve our products, technical documentation, etc. Therefore, the installation manual for this product may have been updated after your product was packaged. The latest revision of the installation manual can always be found at the website above.

The contents of this envelope are the property of the owner. Leave with the owner when installation is complete.

TABLE OF CONTENTS

WARNINGS, TIPS, & REQUIRED TOOLS.....	3
VEHICLE PREP	4-8
DYNAMO INSTALLATION	9
CAB INSTALLATION.....	10-26
CAB FEATURES & OPERATION.....	27
CARE AND MAINTENANCE.....	28
TROUBLESHOOTING	28
BELT ADJUSTMENT	29
SERVICE PARTS	30-35
BOLT TORQUE SPECIFICATIONS	36





WARNINGS, TIPS, & REQUIRED TOOLS

Curtis cabs feature an assembly of parts designed for your vehicle which require adjustment and alignment of components to accommodate vehicle variations and provide proper weather protection. For accurate installation, proper operation, and years of satisfaction, please read and understand the installation and owner's manual fully prior to installing the cab.

From all of us at Curtis, we thank you for choosing our product.

 NOTICE
<p>Curtis Cabs, blades and general accessories add additional weight to the base vehicle. All Curtis accessory weights are listed in product brochures. Deduct the accessory's total weight from the vehicle's rated capacity and never exceed the vehicle's rated capacity including driver and passenger.</p>

<p>▲ WARNING Exposure to Carbon Monoxide can Cause illness, serious injury or death. Never operate vehicle if suspicious of Carbon Monoxide. Inspect exhaust system for leaks monthly. Leaks can result from loose connections, corrosion, cracks or other damage to the exhaust manifold. If leaks are found, repair or replace exhaust system. Do not use vehicle until repair or replacement is complete.</p>

 WARNING	
S e r i o u s I n j u r y o r D e a t h	
	This cab enclosure does not provide protection from rollover or other accidents.
	This cab enclosure does not provide protection from flying objects including golf balls.
	This cab enclosure does not provide protection from lightning. When lightning threatens take cover and do not operate vehicle.

California Health and Safety Proposition 65 Warning: This product may contain chemicals known to the state of California to cause cancer and birth defects or other reproductive harm.

GENERAL INFORMATION BEFORE YOU START

HELPFUL HINTS:

- Refer to parts diagram found in the service parts section of this manual to help identify parts during the assembly process.
- To assist with the cab installation, leave all fasteners loose for later adjustment unless otherwise specified.
- Read and understand all instructions before beginning.
- Apply a silicone sealant to seal any minor gaps that may occur due to vehicle variations.
- Use caution to avoid damaging the factory installed threaded inserts or weld nuts. Begin the thread engagement by hand to avoid or correct potential cross threading.
- Make sure the areas where the supplied self-adhesive hook Velcro® will be applied are clean and dry and at room temperature for best adhesion.

TOOLS REQUIRED:

- | | |
|--|--|
| <ul style="list-style-type: none"> • Set of Standard and Metric Sockets (3/8" + 1/2" Drive) • 3/8" + 1/2" Drive Ratchets and Long Drive Extension • Set of Standard and Metric Open-End Wrenches • Set of Standard and Metric Allen Wrenches • #1, #2, and #3 Phillips Head Screwdrivers • Torque Wrench (1/2" Drive) • Rubber Mallet or Plastic Dead Blow Hammer • Bungee Cord or Twine • Hoisting Strap | <ul style="list-style-type: none"> • Drill/Driver • 9/32" Drill Bit • #2 and #3 Phillips Head Bit • Utility Knife • Pair of Scissors • Shears • Grease • Black Silicone Sealant • Steel Straight Edge |
|--|--|

CAB INSTALLATION

Step 1: (Vehicle Prep)

- 1.1 Park vehicle in a location accessible by an overhead hoist.
- 1.2 Disconnect the negative battery terminal.
- 1.3 See fig. 1.3. Remove the bolt from the battery clamp and replace with a longer one from the supplied hardware kit and re-use the nut, but do not re-connect the battery.

<u>Hardware Used</u>	<u>Qty</u>
5/16x1-1/4 Square Head Bolt	1

- 1.4 See fig. 1.4. Remove and discard the 3 bolts and nuts securing the compressor bracket to the base of the shipping mount and cut any zip ties holding the hoses and wire harness to the shipping mount. Support the compressor using a bungee cord or rope. Do not ever use the hoses to support the compressor or damage may occur.
- 1.5 Remove the Compressor mounting bracket from the compressor. Leave the compressor tensioning bracket attached to the compressor. Save the 3 bolts for reuse.

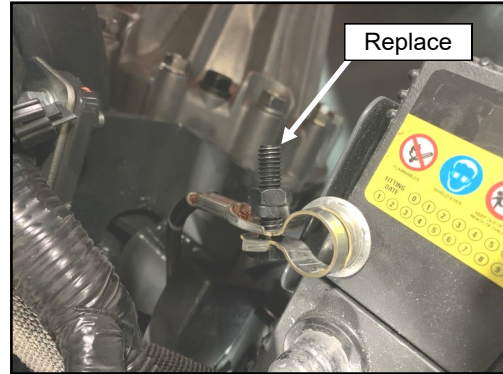

Fig. 1.3 (Replace Negative Battery Bolt)



Fig. 1.4 (Unbolt Compressor)

CAB INSTALLATION

Step 1: (Vehicle Prep)

- 1.6 Remove and discard three bolts from the left side of the engine as shown in fig. 1.6.
- 1.7 See fig. 1.7. Remove and reuse two OEM bolts and install the shroud mounting bracket. Secure the bottom of the bracket with two M6 bolts and two M6 nuts.

Hardware Used

Hardware Used	Qty
M6x1.0x20mm Flange Bolt	2
M6x1.0 Nylock Nut	2

- 1.8 See fig. 1.8. Install the compressor mounting bracket behind the alternator wiring. The alternator wiring does not need to be removed, but be careful going past with the bracket. Secure with the hardware listed below.

Hardware Used

Hardware Used	Qty
M10x1.25x30mm Flange Bolt	3

Note: Ensure there is a gap between the alternator power wire and the compressor mounting bracket. If needed, loosen the nut, rotate the wire down, and re-tighten the nut.

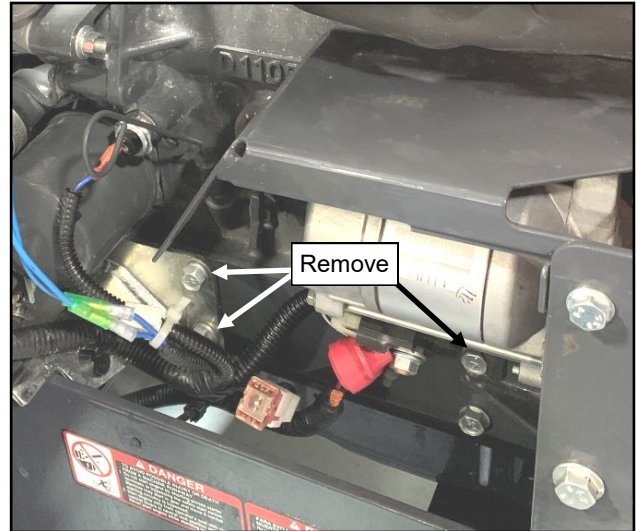

Fig. 1.6 (Remove bolts)

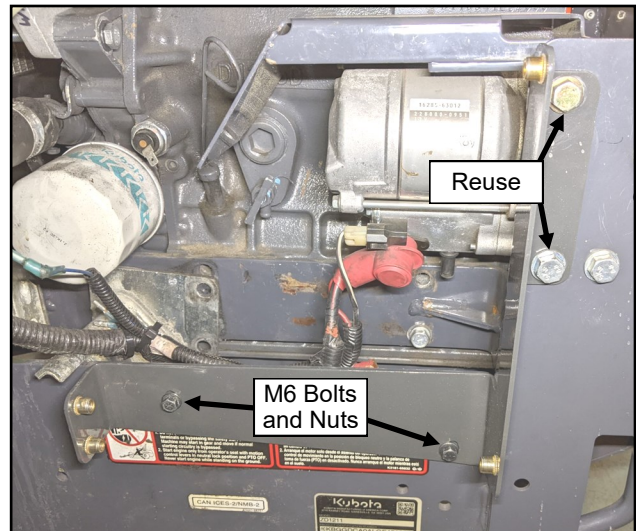

Fig. 1.7 (Install shroud mounting bracket)

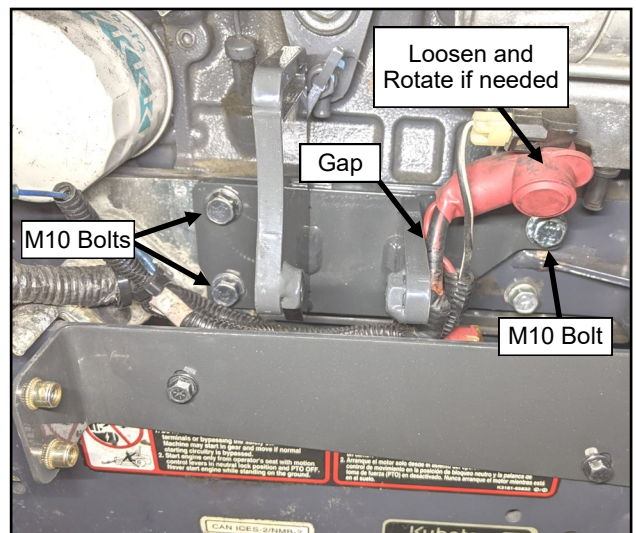

Fig. 1.8 (Install compressor mounting bracket)

CAB INSTALLATION

- 1.9 See fig. 1.9. Remove the fasteners securing the right side drive lever cover. Remove drive lever cover by lifting up and over the drive lever. Set aside hardware for later use. Note: Lower screw only needs to be loosened to prevent losing any hardware.
- 1.10 See fig. 1.10. Thoroughly wipe the outside of the drive lever cover with isopropyl alcohol. Once dry, adhere the supplied Velcro along the edge around the entire opening as shown.
- 1.11 See fig. 1.11. Locate the supplied drive lever filler labeled V-00075-R, make a cone shape by attaching one side to the other via the factory sewn-on vinyl.
- 1.12 See fig. 1.12. Align the filler's Velcro seam with corner opening near the cover's fastener slot. Slip the cone shaped drive lever filler up through the drive lever cover. Fold the filler over and attach it to the drive lever cover.
- 1.13 Repeat steps 1.9 through 1.12 on the left side of the vehicle.



Fig. 1.9 (Right Side Drive Lever Cover)



Fig. 1.10 (Drive Lever Cover Velcro)



Fig. 1.11 (Right Drive Lever Filler)

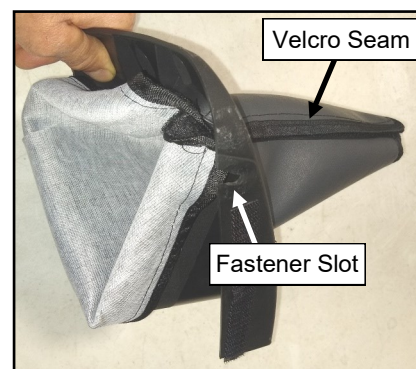

Fig. 1.12 (Drive Lever Filler Orientation)

CAB INSTALLATION

- 1.14 See fig. 1.14. Locate the cotter pin retaining the blade height adjustment knob. Remove and set aside the cotter pin and adjustment knob.
- 1.15 See fig. 1.15. Remove and set aside the three screws securing the plastic cover to the right side fender. Pull the molded handle from the throttle lever and engage the blade lever.
- 1.16 Carefully lift the cover up and over the throttle and blade engagement levers. Disconnect the ignition switch from its harness then place the cover aside.

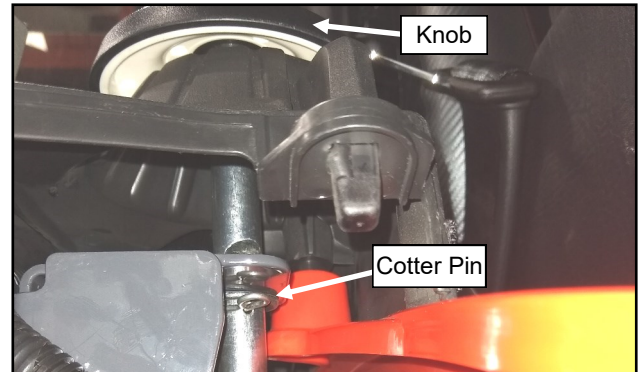

Fig. 1.14 (Blade Height Adjustment Knob)

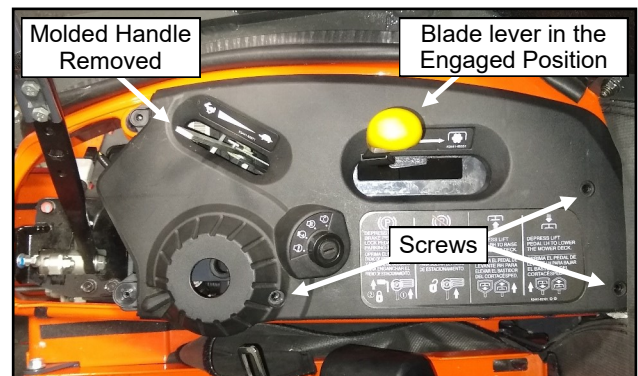

Fig. 1.15 (Right Side Cover)

CAB INSTALLATION

- 1.17 See fig. 1.17. Slip the supplied clip nut onto the tab rearward of the blade engagement lever.

<u>Hardware Used</u>	<u>Qty</u>
#8 Clip Nut	1

- 1.18 See fig. 1.18. Place the supplied sealing brush panel over the levers as shown. Secure using the supplied hardware listed below. Fully tighten at this time.

Note: The 22mm O.D. x 4.95mm thick washer (7/8" O.D. x 3/16" thick) is used as a spacer, it's placed underneath the brush panel.

<u>Hardware Used</u>	<u>Qty</u>
#8 x 5/8" Sheetmetal Screw	1
1/2" O.D. Washer	1
22mm O.D. (.87") Washer	1
#10-32 x 3/4" Screw	1
#10-32 Lock Nut	1

- 1.19 See fig. 1.19. Reinstall the large plastic cover, ignition switch harness, molded throttle lever handle and blade height adjustment knob along with its cotter pin.

Reminder: Place the blade engagement lever into the disengagement position at this time.

Leave the drive lever covers off at this point and continue installing the cab.

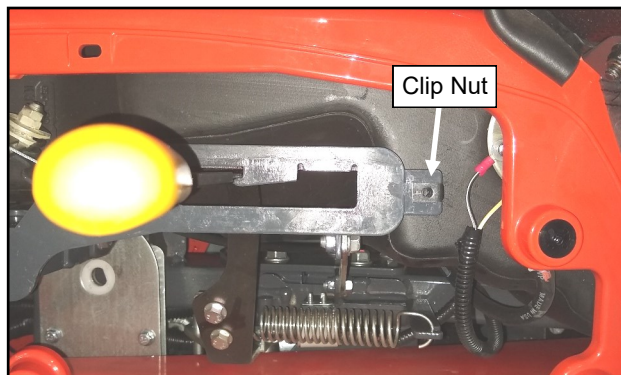

Fig. 1.17 (Clip Nut Orientation)

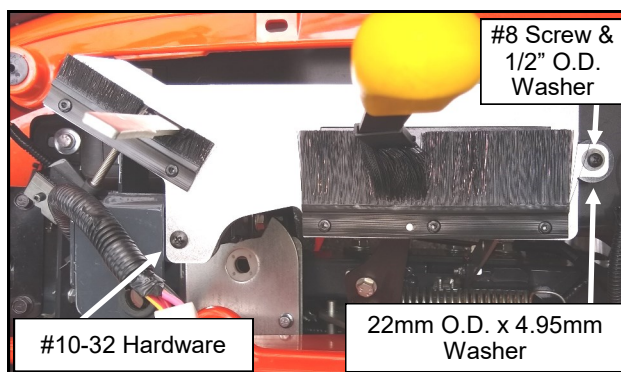

Fig. 1.18 (Brush Panel Orientation)



Fig. 1.19 (Right Side Cover Reinstalled)

CAB INSTALLATION

Step 2: (DYNAMO INSTALLATION)

- 2.1 See figure 2.1. Remove the OEM dynamo from the vehicle and discard. Save the hardware for reuse.
- 2.2 See figures 2.2a and 2.2b. Use a 10mm wrench to remove the OEM dynamo tensioner bracket and discard. Reuse the hardware and install the supplied larger bracket. Do not fully tighten the bolts at this time.
- 2.3 See fig. 2.3. Mount the new dynamo in the original location. Ensure the bolt starts on the engine side and the washers and nut are on the dynamo side. Do not fully tighten the hardware at this time.
- 2.4 Install the belt over the new dynamo pulley. Ensure the belt is properly running in the V groove on the crank pulley, water pump pulley, and new dynamo pulley. See fig. 2.4.
- 2.5 Install the tensioner bolt. Do not fully tighten at this time.
- 2.6 Tighten the 2 tensioner bracket bolts.
- 2.7 Tension the belt and tighten top dynamo bolt with a 12mm wrench.
- 2.8 Tighten lower mounting hardware with a 13mm wrench and a 13mm socket.

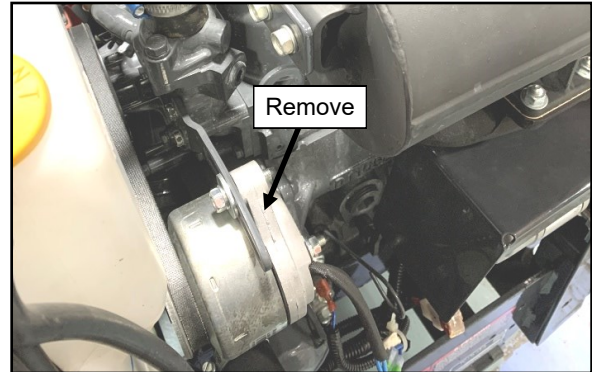

Fig. 2.1 (Remove OEM Dynamo)

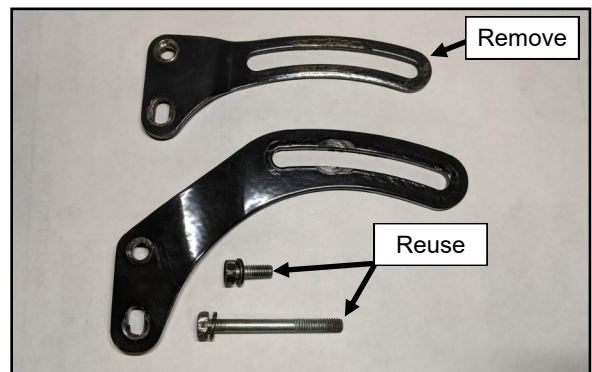

Fig. 2.2a (Replace Tensioner Bracket)

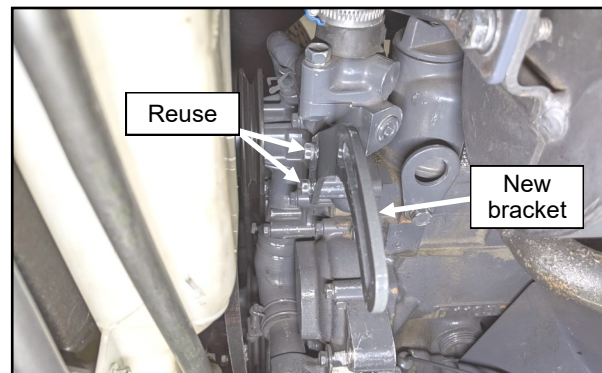

Fig. 2.2b (Install replacement Tensioner Bracket)

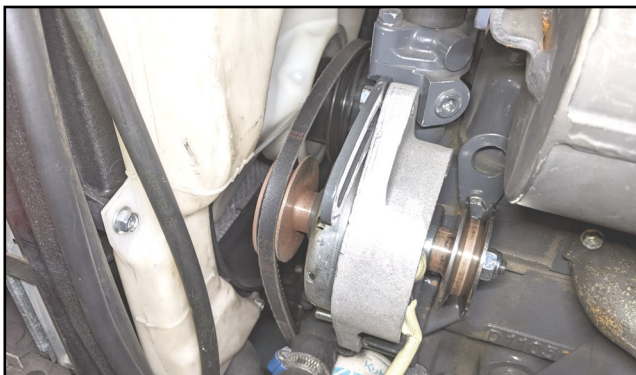

Fig. 2.4 (Install belt and set the tension)

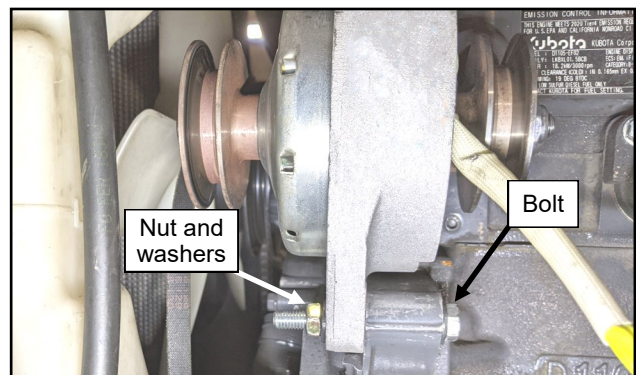

Fig. 2.3 (Mount new Dynamo)

CAB INSTALLATION

Step 3: (Install ROPS Mounts)

- 3.1 See fig. 3.1. Remove the left and right hand tension screws and clips on the ROPS and discard.
- 3.2 Remove the ROPS pin and bolt from the left side and discard. See fig. 3.1. Leave the right side installed at this time.
- 3.3 See fig. 3.3. Remove the upper bolt on the cross hose protector as shown and discard.
- 3.4 See fig. 3.4. Install the left ROPS mount using the following hardware. The large bolt in the pivot hole should be tightened just enough so that the ROPS can still tilt without damaging the paint. The large bolt in the hole where the pin was removed, should be installed through the bracket, but no nut is installed at this time. Tighten the smaller M8 bolt.

<u>Hardware Used</u>	<u>Qty</u>
M16x2x80mm Hex Head Bolt	2
M16x30 Steel Flat Washer	3
M16x2 Locknut	1
M8x1.25x30mm Flange Bolt	1

- 3.5 Repeat steps 3.2, 3.3, and 3.4 for the right side.
- 3.6 See fig. 3.6. Remove the lower M16 bolts from the previous steps and tilt the ROPS back and re-use the bolts to pin in the tilted position. Be careful not to damage the engine hood if it is in the open position. The nuts on the lower bolts will be installed in a later step.

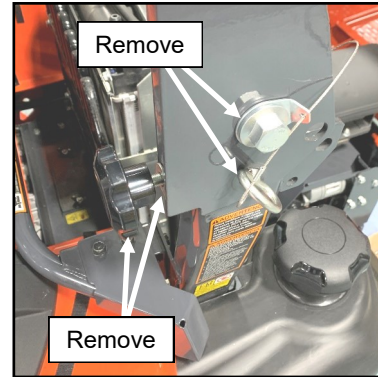

Fig. 3.1 (Remove hand screws and ROPS Bolt)



Fig. 3.3 (Remove upper bolt)

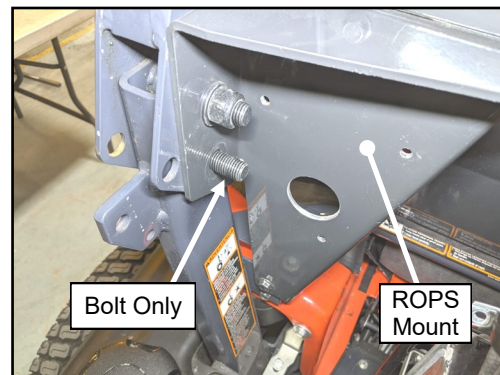

Fig. 3.4 (Install Left ROPS Mount)

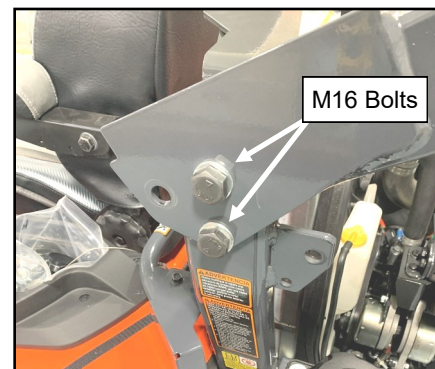

Fig. 3.6 (Tilt the ROPS)

CAB INSTALLATION

Step 4: (Vehicle Prep)

- 4.1 Remove and discard the four floorboard bolts shown in Figure 4.1. If the mower is a 60", remove two additional bolts in the location shown.
- 4.2 See fig. 4.2. Cut the rubber tabs on the floormat at the bolt locations as shown so that the hole is clearly accessible.
- 4.3 See fig. 4.3. Remove the pine tree clips from the floormat at the 12 locations shown.
- 4.4 If installing on a 60" mower, remove and save the tilting front cover at the front of the machine.
- 4.5 See fig. 4.5. Install the pedal seal panel on top of the floormat as shown. Secure to the floorpan using the following hardware. The floorpan may need to be lifted slightly in the front on a 60" mower to access the center screw.

Hardware Used

	<u>Qty</u>
#10-32x3/4" Phillips Head Screw	6
#10-32 Flange Nut	6

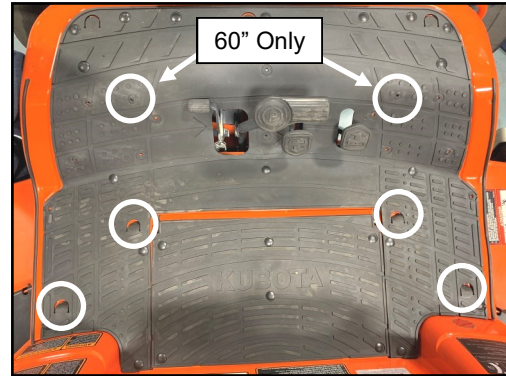

Fig. 4.1 (Remove Bolts)

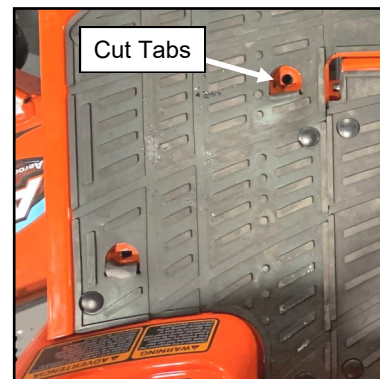

Fig. 4.2 (Cut Floormat)

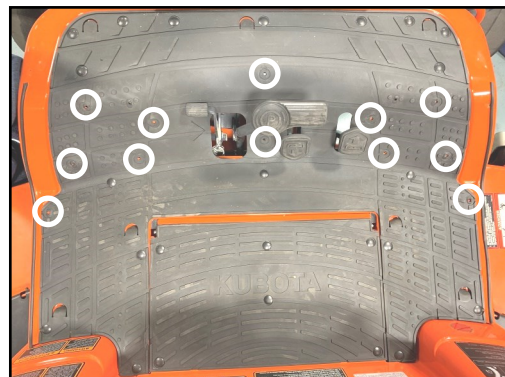

Fig. 4.3 (Remove Pine Tree Clips)

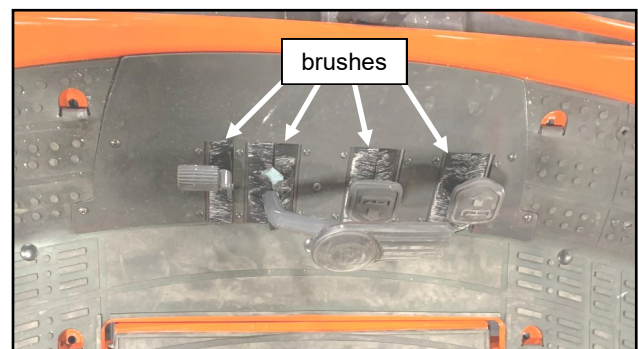

Fig. 4.5 (Install Sealing Brushes)

CAB INSTALLATION

- 4.6 Install self-adhesive seal around the edge of the floor pan as shown and cut to length. Refer to Figure 4.6a for 60" and 4.6b for 72".

Note: placement on the 72" machine. Seal should follow along the white line shown in fig. 4.6b.

- 4.7 See fig. 4.7. Insert spacer bushings into the depressions where the floorboard bolts were removed. (72" uses 4 spacers, 60" uses 6 spacers)

Hardware Used

1/2" Long Spacer

Qty

4 or 6

- 4.8 See fig. 4.8. Flip the seat forward and disconnect and remove the OEM regulator.

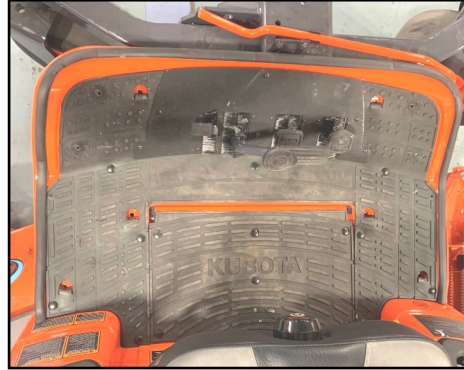

Fig. 4.6a (Seal location on 60")



Fig. 4.6b (Seal location on 72")

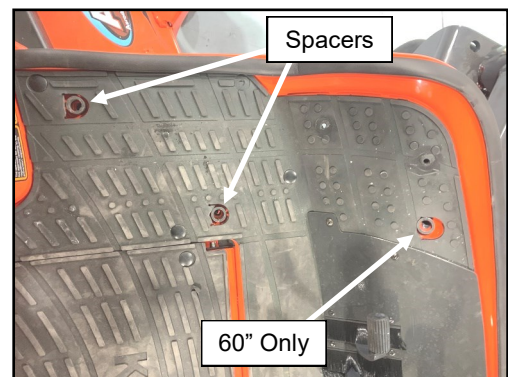

Fig. 4.7 (Install Spacers)

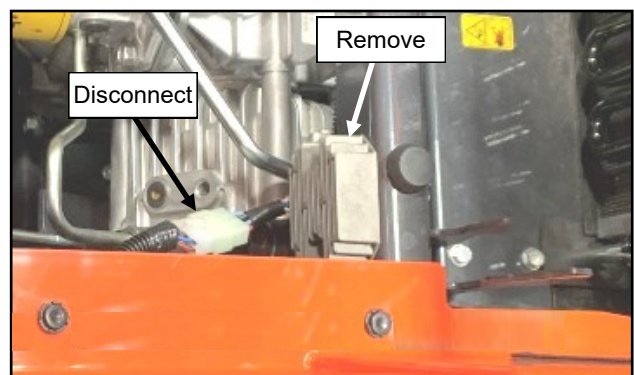

Fig. 4.8 (Disconnect and Remove OEM Regulator)

CAB INSTALLATION

- 4.9 See fig. 4.9. Secure the OEM regulator wiring out of the way with a zip tie.

Step 5: (Cabin Installation)

- 5.1 See fig. 5.1. Lower the seat and slide the seat all the way forward and use the knob on the seat to tilt the seatback forward as much as possible.
- 5.2 Remove the doors from the cabin and set aside carefully to prevent scratching the panels.
- 5.3 Remove the 3 bolts securing the compressor bracket to the base of the shipping mount and cut any zip ties holding the hoses and wire harness to the shipping mount. Support the compressor using a bungee cord or rope. Do not ever use the hoses to support the compressor or damage may occur.
- 5.4 See fig. 5.4. Position a lifting strap where shown so that it sits roughly 2" in front of the b-pillar.

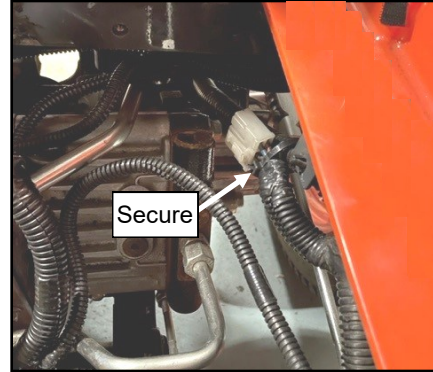

Fig. 4.9 (Secure OEM Regulator Wiring)



Fig. 5.1 (Move Seat forward, Rotate seatback)

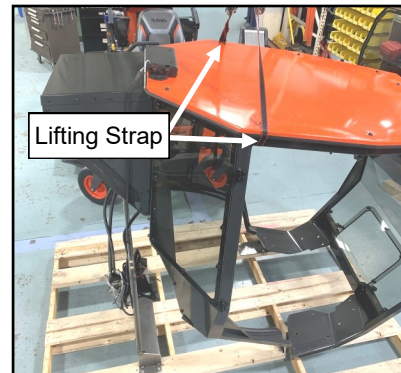

Fig. 5.4 (Position lifting strap)

CAB INSTALLATION

- 5.5 See figures 5.5a and b. Put tension on the lifting strap with the overhead hoist. Remove and discard the 4 bolts holding the rear of the cab down to the shipping bracket (located inside the cab) as well as the 4 lag screws holding the floorboards to the pallet.
- 5.6 With assistance, lift the cabin and position over the vehicle. Be sure to support the A/C compressor so that it never hangs from the hoses.
- 5.7 Lower the cabin slowly onto the vehicle being careful to not scratch the fenders with the rear edge of the floorboard. The A/C compressor should pass to the inside of the ROPS and end up on the left side of the engine.

- 5.8 See fig. 5.8. Fasten the rear of the cabin to the ROPS mounts using the following hardware. Leave loose at this time.

<u>Hardware Used</u>	<u>Qty</u>
5/16-18 x 1-3/4 Hex Head Bolt	4
5/16-18 Flange Nut	4

- 5.9 See fig. 5.9. Fasten the cab to the floor of the tractor using the following hardware. Note: On 60" tractors, use 6 M8 bolts. On 72" tractors, only install 4 M8 bolts and leave additional slot open.

<u>Hardware Used</u>	<u>Qty</u>
M8x1.25x40mm Button Head Bolt	4 or 6
5/16x1-1/4" Steel Fender Washers	4 or 6
1/4-20x1" Button Head Bolt	6
1/4x1" Steel Fender Washers	6
1/4-20 Flange Nut	6

- 5.10 Tighten all floorboard bolts and rear cabin bolts at this time
- 5.11 Raise ROPS bar and loosely re-install M16 bolts used to pin it.

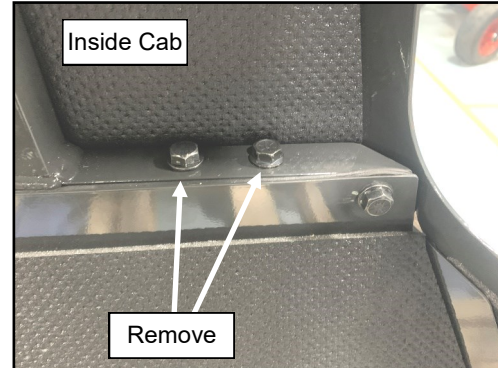

Fig. 5.5a (Remove Rear Bolts)



Fig. 5.5b (Remove Lag Screws)

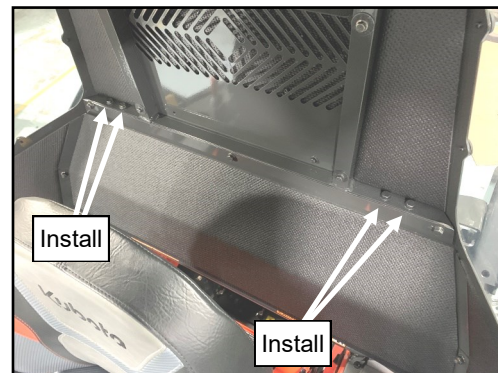

Fig. 5.8 (Install Rear Bolts)

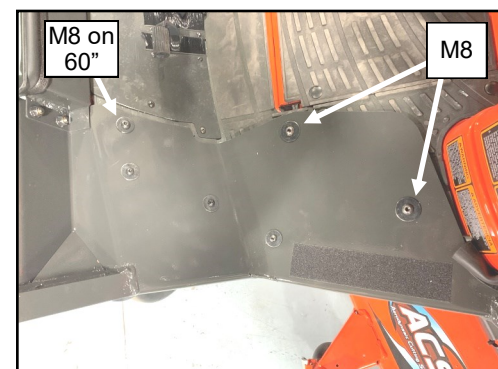

Fig. 5.9 (Install Floorboard Bolts)

CAB INSTALLATION

5.12 See fig. 5.12. Loosen the 4 factory installed 5/16" bolts securing the upper ROPS mount so that the mount can slide up against the underside of the ROPS.

5.13 See fig. 5.13. Install the upper ROPS clamp plate to the top side of the ROPS and secure with the following hardware. Bolts can be tightened at this time. Hand tighten only. Do not over-tighten or plate will deform.

<u>Hardware Used</u>	<u>Qty</u>
5/16-18x2-1/2" Flange Bolts	4
5/16x1" Steel Fender Washers	8
5/16-18 Flange Nut	4

5.14 Re-tighten the bolts loosened in step 5.12.

5.15 See fig. 5.15. Install the washer and nuts onto the M16 ROPS bolts and tighten at this time. Note: The tightening torque is different for the upper and lower bolt.

Torque the upper bolt to 167 to 196 Nm (123 to 144 lbf-ft)

Torque the lower bolt to 78 to 90 Nm (58 to 66 lbf-ft)

<u>Hardware Used</u>	<u>Qty</u>
M16x30 Steel Flat Washer	1
M16x2 Locknut	1

5.16 See fig. 5.16. If installed on a 72" mower, drill 9/32" holes through the tractor floorboard centered on the open slots in the cab floorboards. Do not drill too deep to avoid damaging any items on the underside of the floorboard.

5.17 Dab the raw edge of the holes in the steel floorboard with some orange touch-up paint to prevent corrosion.

5.18 Install the following hardware into the newly drilled holes and tighten.

<u>Hardware Used</u>	<u>Qty</u>
1/4-20x1" Button Head Bolt	2
1/4x1" Steel Fender Washers	2
1/4-20 Flange Nut	2

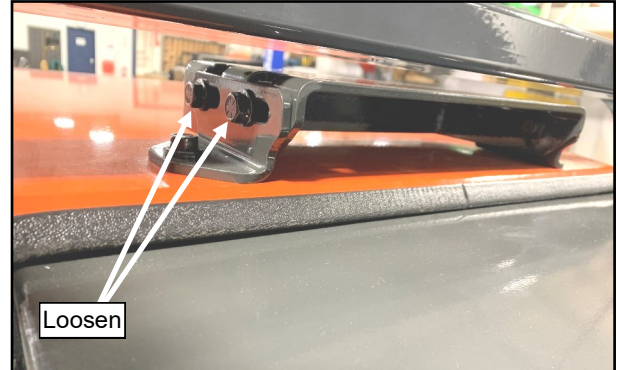

Fig. 5.12 (Loosen Upper ROPS Mount)

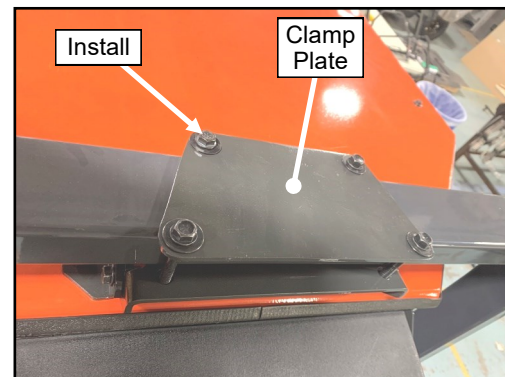

Fig. 5.13 (Install Upper ROPS Clamp Plate)

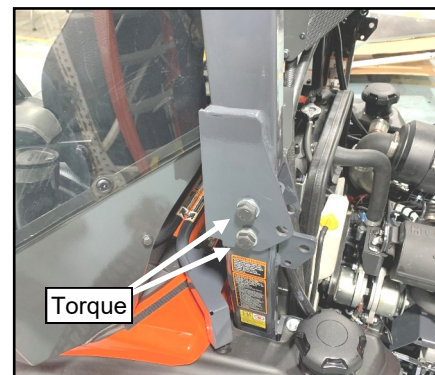

Fig. 5.15 (Tighten ROPS Bolts)

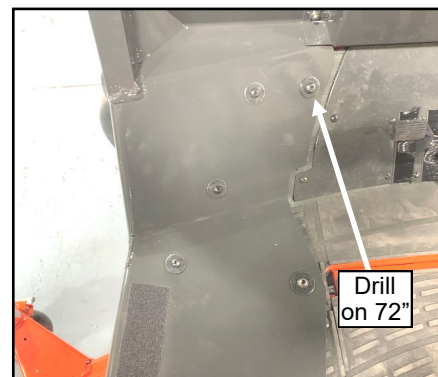

Fig. 5.16 (Drill Hole on 72" Mowers)

CAB INSTALLATION

Step 6: (Compressor Installation)

- 6.1 Move compressor into location on the left side of the engine and secure to the bracket with the hardware removed on step 1.8. See figure 6.1. Do not tighten hardware at this time.

<u>Hardware Used</u>	<u>Qty</u>
M10x1.25x30mm Flange Bolt	3

- 6.2 See fig. 6.2. Install the supplied belt and tension by pivoting the compressor away from the engine. Tighten all compressor pivot bolts at this time.

Note: The oil pressure sensor wire might be close to contacting the belt. To ensure proper clearance, the terminal might have to be bent downward.

- 6.3 See fig. 6.3. Install the supplied rubber grommet to the left side ROPS bracket.

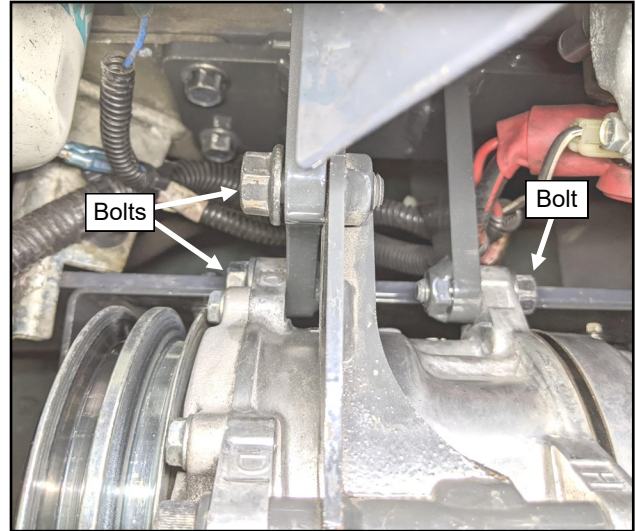

Fig. 6.1 (Install Compressor)

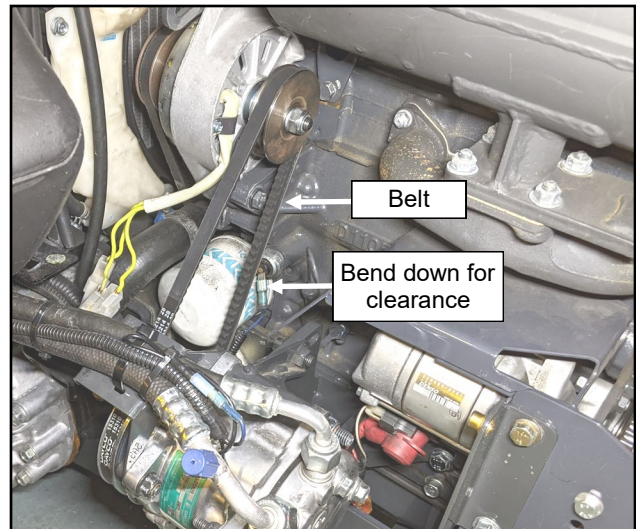

Fig. 6.2 (Install Belt and Tension)



Fig. 6.3 (Install Rubber Grommet)

CAB INSTALLATION

6.4 See figs. 6.4a and 6.4b. Pass the regulator wiring through the grommet and install the regulator to the front of the left ROPS bracket. With one of the regulator mounting bolts and nuts, secure the A/C hose with a p-clamp as shown in figure 6.4b. Twist clamp and adjust hose position so that hose does not contact sharp edges of ROPS bracket.

Hardware Used	Qty
1/4-20x1-1/2" Socket Head Bolt	2
1/4-20 Flange Nut	2
3/4" P-Clamp	1

Note: The supplied regulator might look like the version shown in fig. 6.4c. Pass the regulator wiring through the grommet and install the regulator to the front of the left ROPS bracket. With a button head bolt and nut, secure the A/C hose with a p-clamp as shown in figure 6.4b. Twist clamp and adjust hose position so that hose does not contact sharp edges of ROPS bracket.

Hardware Used	Qty
1/4-20x1-1/2" Socket Head Bolt	2
1/4-20x1" Button Head Bolt	1
1/4-20 Flange Nut	3
3/4" P-Clamp	1

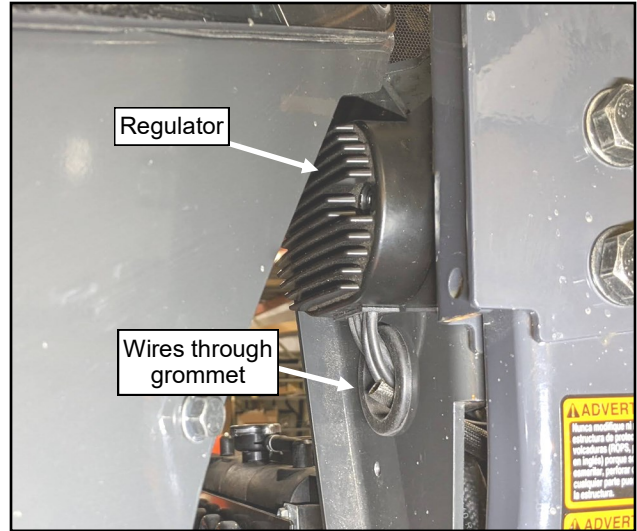

Fig. 6.4a (Secure Regulator to ROPS Bracket)

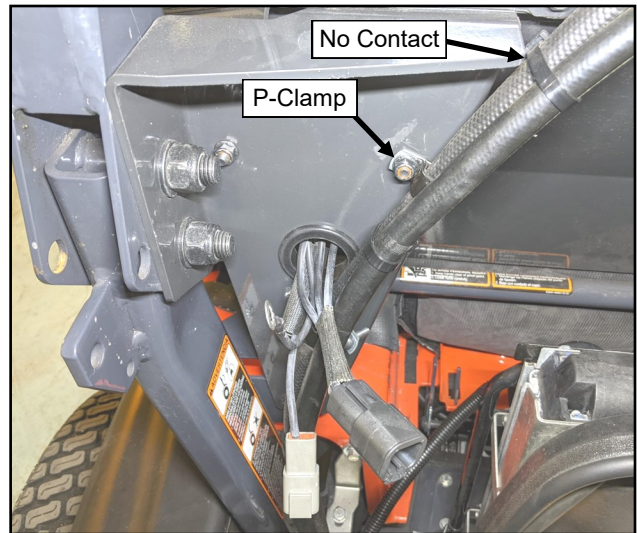

Fig. 6.4b (Secure Regulator to ROPS Bracket)

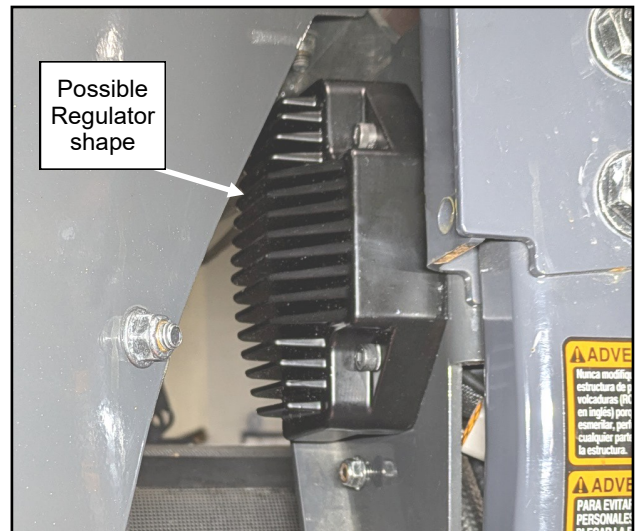

Fig. 6.4c (Possible Alternate Regulator version)

CAB INSTALLATION

Step 7: (Wiring)

7.1 See fig. 7.1. Connect the dynamo and regulator power wiring harnesses to the regulator. Further down the ROPS bracket than in fig. 6.4b on the previous page, secure both the regulator and power harness ground wire ring terminals together between another p-clamp on the A/C hose and the ROPS bracket. Twist clamp and adjust hose position so that hose does not contact sharp edges of ROPS bracket.

Using one cable tie, secure the wire harness to the compressor lines just below the regulator connectors.

<u>Hardware Used</u>	<u>Qty</u>
1/4-20x1" Button Head Bolt	1
1/4-20 Flange Nut	1
3/4" P-Clamp	1
Cable Tie	1

7.2 See fig. 7.2. Secure both A/C hoses to the vehicle frame using a cable tie as shown. Ensure that the hoses will not contact any sharp edges.

<u>Hardware Used</u>	<u>Qty</u>
Cable Tie	1

7.3 See fig. 7.3. Connect the dynamo wiring harness to the dynamo. Using one cable tie, secure the wire harness to the compressor lines where compressor lines bend to go to the compressor. Ensure that the wire harness will not contact any sharp edges. Make sure hood closes without hitting the wire harness.

<u>Hardware Used</u>	<u>Qty</u>
Cable Tie	1

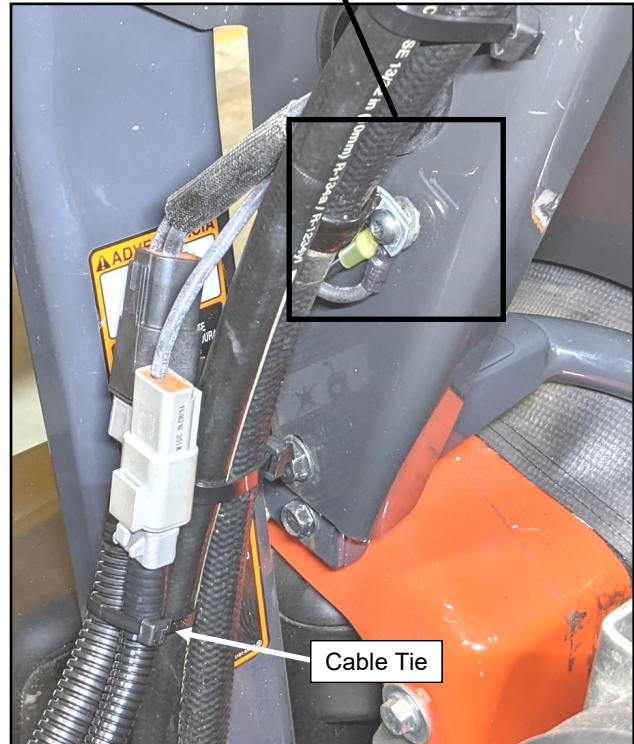
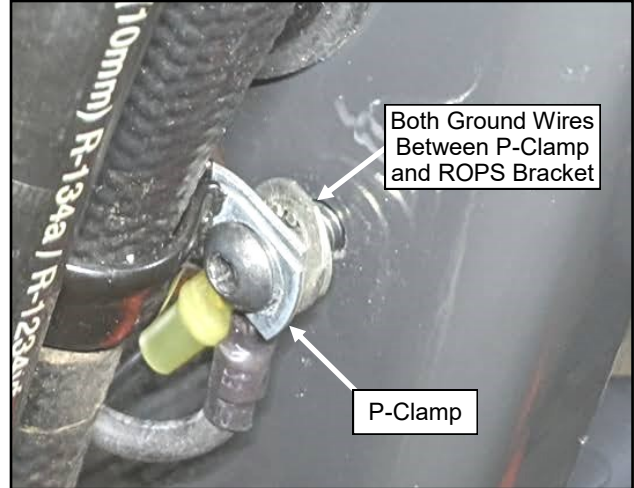

Fig. 7.1 (Connect Dynamo Wire Harness)

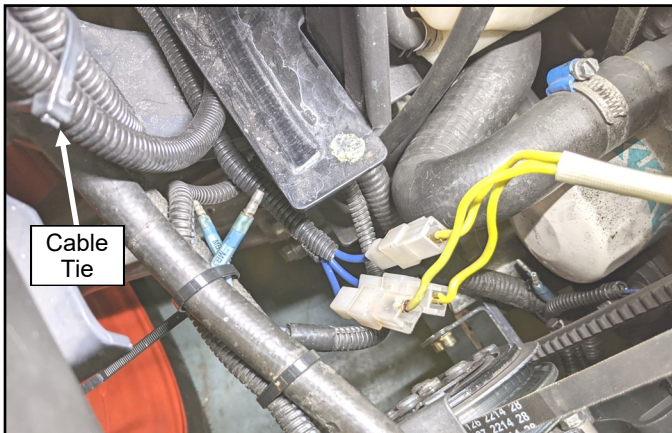

Fig. 7.3 (Connect Dynamo Wiring Harness)

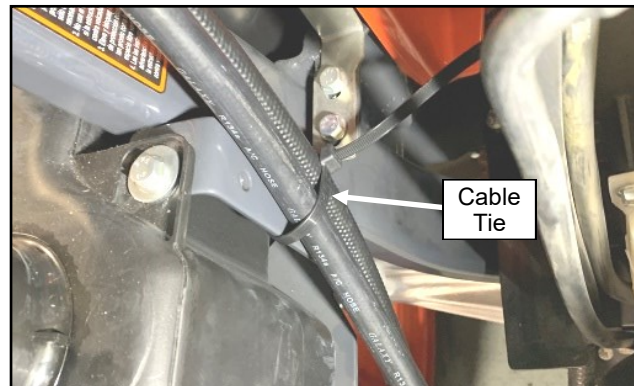

Fig. 7.2 (Cable Tie Hoses)

CAB INSTALLATION

7.4. See fig. 7.4. Route the regulator power harness forward over the ROPS tube but below the flat area that the hood seals on when it is closed.

Avoid any moving parts like the seat release levers.

Continue running the harness under the seat support cross frame and around to the other side. Route it over the right side of the ROPS, again below the flat area that the hood seals on when it is closed, and ending at the battery.

7.5 See fig. 7.5. Cut the cable ties securing the bundled A/C wiring harness and attach the harness to the lower ROPS brackets with p-clamps as shown.

<u>Hardware Used</u>	<u>Qty</u>
1/4-20x1" Button Head Bolt	2
1/4-20 Flange Nut	2
3/4" P-Clamp	2

7.6 See fig. 7.6. Using one cable tie, secure the wire harness to the vehicle frame. Ensure that the wire harness will not contact any sharp edges. Make sure hood closes without hitting the wire harness.

<u>Hardware Used</u>	<u>Qty</u>
Cable Tie	1

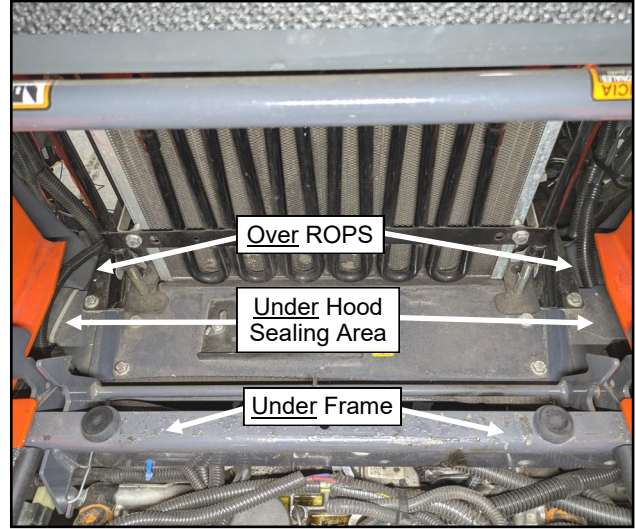

Fig. 7.4 (Route Regulator Power Harness)

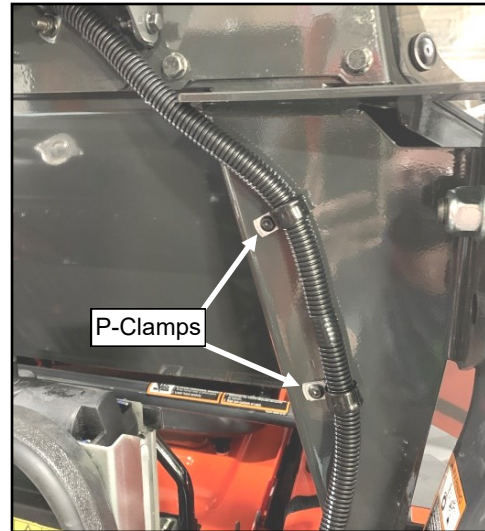

Fig. 7.5 (P-Clamp Wire Harness to ROPS Bracket)

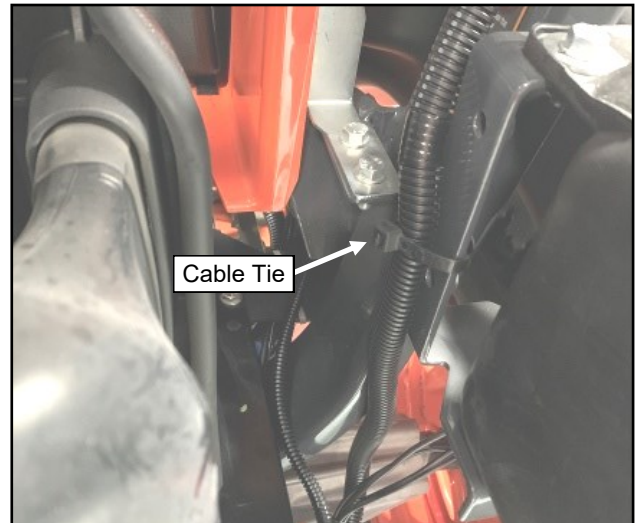

Fig. 7.6 (Secure Wire Harness)

CAB INSTALLATION

- 7.7 See fig. 7.7. Install the ring terminals on the red wires from both the main harness and from the regulator power harness onto the stud on the positive battery clamp (outboard of the existing battery clamp nut) and secure with the following hardware.

<u>Hardware Used</u>	<u>Qty</u>
M6x1.0 Nut	1

- 7.8 See fig. 7.8. Locate the portion of the wire harness with two ring terminals crimped on the ends of black and gray wires. Route the ring terminals forward over the ROPS tube in front of the battery next to the existing wiring and up along the right side of the vehicle to right hand control.

Note: Wires must be routed above the ROPS, but below the flat area that the hood seals on when it is closed.

Avoid any moving parts.

- 7.9 See fig. 7.9. Route the wires up behind the right control stick and connect to the supplied switch as shown. The gray wire should go to the center screw (NO, #3) and the black wire should be connected to the COM, #1 screw.

It is recommended to do the assembly over the floor of the tractor to prevent losing any screws.

- 7.10 Remove the bolt shown in figure 7.10 and re-install with the switch bracket so that the spring loaded switch rod will be contacted by the throttle control lever. **Adjust the bracket and switch so that when the throttle control lever is beyond 3/4 throttle the switch is engaged.** The switch can be rotated on the bracket and the bracket can also be rotated where it mounts to the vehicle.

Ensure that the throttle lever is activating the switch when moved to its max rpm position. An audible click should be heard when moving the throttle with the vehicle off.

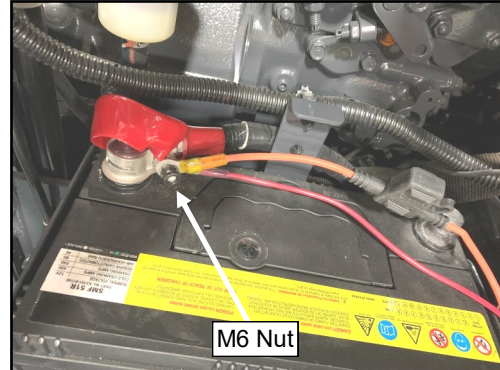

Fig. 7.7 (Attach Red Wires to Battery)



Fig. 7.8 (Route Harness to Right Control Stick)



Fig. 7.9 (Connect Wires to Switch)

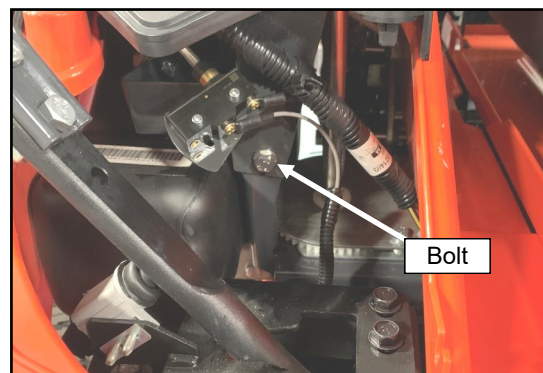

Fig. 7.10 (Install Switch Bracket)

CAB INSTALLATION

7.11 See fig. 7.11. Install the right side drive lever cover and the previously attached vinyl filler using the hardware removed during step 1.9.

7.12 See fig. 7.12. Once the drive lever cover hardware has been tightened, move the lever all the way out away from the operator, in the park position. Using a China marker or other non-permanent marker, make a mark on the drive handle at the top of the filler. Wipe area with isopropyl alcohol and adhere a piece of the supplied Velcro around handle at the mark previously made.

7.13 See fig. 7.13. Wrap filler around drive lever attaching Velcro on filler to Velcro on handle.

7.14 Repeat steps 7.11 through 7.13 on the left side.



Fig. 7.11 (Drive Lever Cover & Filler)



Fig. 7.12 (Drive Lever Velcro)



Fig. 7.13 (Filler to Handle)

CAB INSTALLATION

7.15 See fig. 7.15. Route the remaining section of the harness with the yellow wire and bullet connector forward from the battery area over the ROPS and up under the seat just like the regulator harness in step 7.4. The harness should run across the top of the transmission along the existing OEM harness and end on the left side of the vehicle.

Note: Wires must be routed above the ROPS, but below the flat area that the hood seals on when it is closed.

7.16 See fig. 7.16. Cut the blue tape on the OEM vehicle wire harness under the seat to expose a male and female bullet terminal. Connect the male bullet terminal at the end of the yellow wire on the A/C wire harness to the female bullet terminal on the OEM harness.

NOTE: If the supplied wiring harness has a white 6-pin connector, zip tie it out of the way as shown, it is not used in this application.

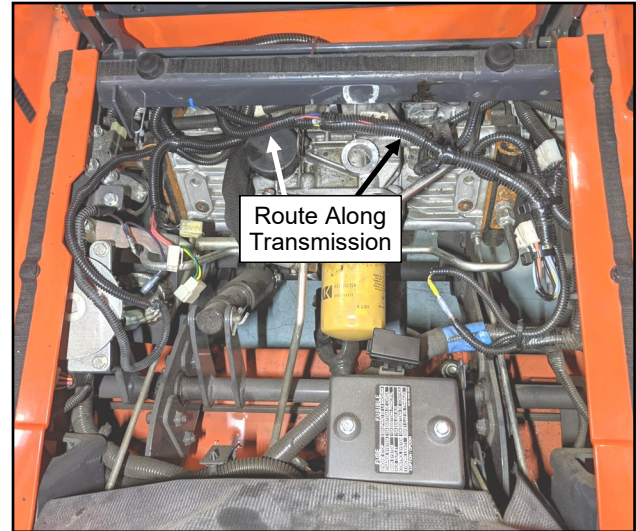

Fig. 7.15 (Route Wiring)

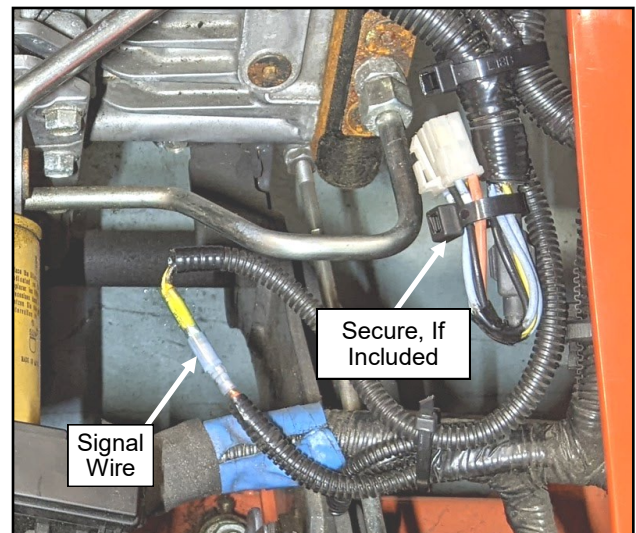

Fig. 7.16 (Locate OEM Signal Wire)

CAB INSTALLATION

- 7.17 Route the remaining section of wires on the A/C harness out the rear of the left side of the vehicle so that they pass above the ROPS tube and end near the compressor.
- 7.18 See fig. 7.18. Connect the female bullet terminal on the end of the blue wire to the male bullet terminal on the compressor.
- 7.19 Remove the bolt shown in figure 7.18 and install the 3/8" ring terminal from the A/C harness onto the bolt so that it is contacting the ear of the compressor.
- 7.20 Use cable ties to secure the wire harness going to the compressor to the hoses.
- 7.21 Re-install the negative terminal back onto the battery post and tighten.
- 7.22 See fig. 7.22. Install the 5 ring terminals on the black ground wires to the battery bolt and secure with an additional nut.

Hardware Used
5/16-18 Serrated Nut

Qty
1

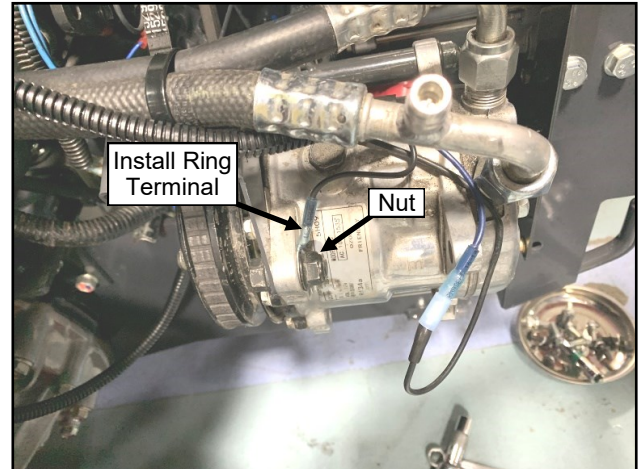

Fig. 7.18 (Connect Dynamo Wiring)



Fig. 7.22 (Connect Ground Wires)

CAB INSTALLATION

Step 8: (Functionality Testing)

- 8.1 Ensure that all wires and hoses are securely fastened with cable ties to prevent any rubbing or chaffing on sharp or hot objects.
- 8.2 Turn the vehicle on and check to make sure that belts and components are not vibrating excessively.
- 8.3 Bring engine to full throttle, turn on A/C blower, and move thermostat to cold.
- 8.4 Check to make sure A/C is blowing cold air.
- 8.5 Turn engine off and allow to cool.

Step 9: (Shroud Installation)

- 9.1 See fig. 9.1. Assemble the front shroud panel to the front side of the bracket installed in step 1.10. Do not fully tighten fasteners at this time.

Hardware Used

1/4-20x3/4" Flange Bolts

Qty

2

- 9.2 See fig. 9.2. Assemble the rear shroud panel and cover together as shown. Leave the bolts loose at this time.

Hardware Used

1/4-20x3/4" Flange Bolts

Qty

3

- 9.3 See figs. 9.3a and 9.3b. Assemble the rear shroud panel over the compressor. **Secure the dynamo wiring to the shrouds with a p-clamp.** Tighten all shroud bolts at this time. Verify that there is clearance all around hoses and belt. Loosen shroud and adjust, if necessary, to gain adequate clearance.

Hardware Used

1/4-20x3/4" Flange Bolts

Qty

6

1/2" P-Clamp

1

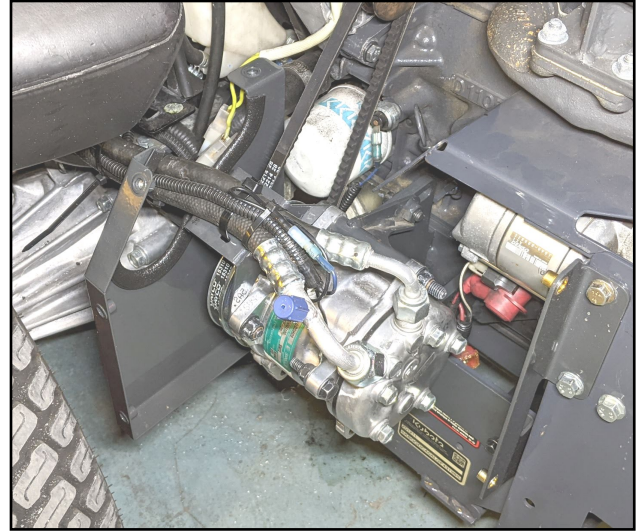

Fig. 9.1 (Install Front Shroud Panel)

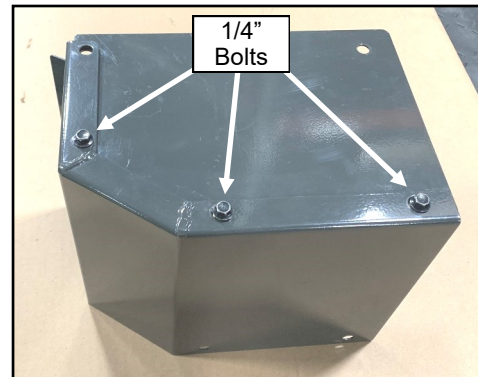

Fig. 9.2 (Assemble Cover Panel)

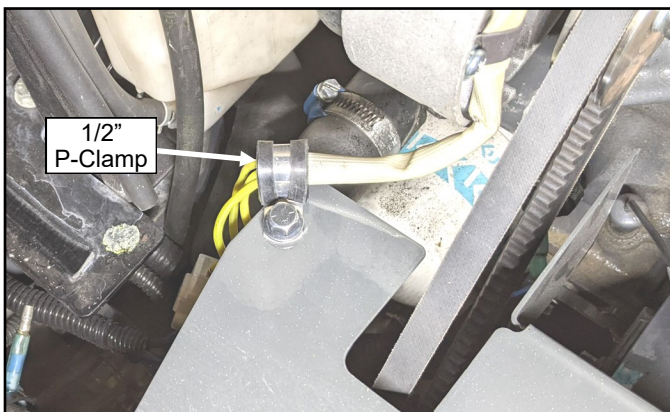

Fig. 9.3b (Secure Dynamo Wires with P-Clamp)

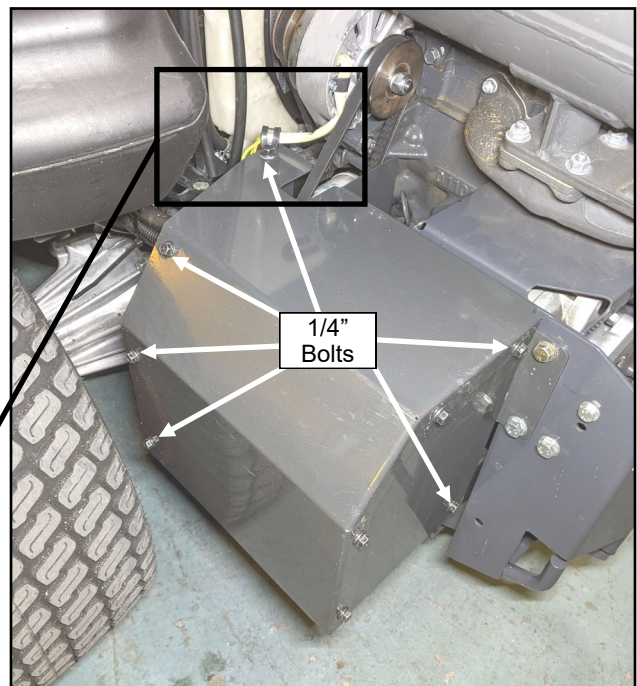

Fig. 9.3a (Install Rear Shroud Panel)

CAB INSTALLATION

Step 10: (Filler Installation)

10.1 See fig. 10.1. Raise the seat and remove the rear fender clip on the left side. Save for reuse. Install the left fender filler panel by working and compressing the rubber seal into place. Loosely secure the top with the supplied hardware, with the bolts on the outside and nuts on the inside. Push the bottom of the filler into place and secure with the fender clip removed earlier. Ensure the rubber seal is in place and tighten hardware.

<u>Hardware Used</u>	<u>Qty</u>
5/16-18 x 3/4 Hex Head Bolt	3
5/16-18 Flange Nut	3

10.2 See fig. 10.2. Repeat step 10.1 with the right side fender filler.

<u>Hardware Used</u>	<u>Qty</u>
5/16-18 x 3/4 Hex Head Bolt	3
5/16-18 Flange Nut	3

10.3 See fig. 10.3. Install one of the supplied strips of bulb rubber to the inside lower edge of the left fender. It should go from the step down at the front to the cross bar at the back.

Repeat on the right side. The grip on the bulb rubber should stay straight and not follow the notch in the fender.

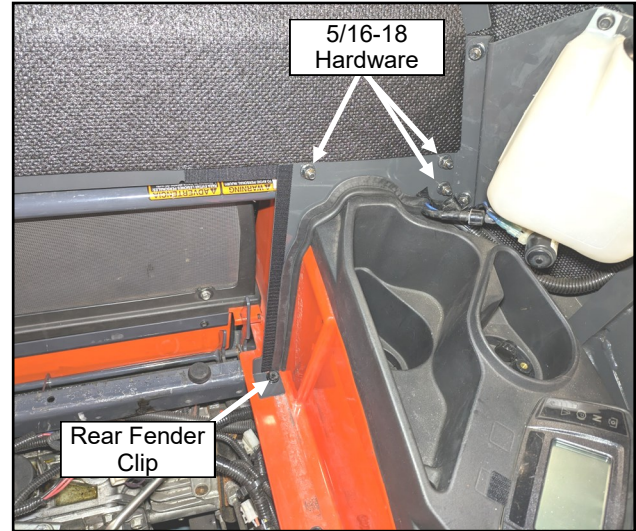

Fig. 10.1 (Install Left Fender Filler)

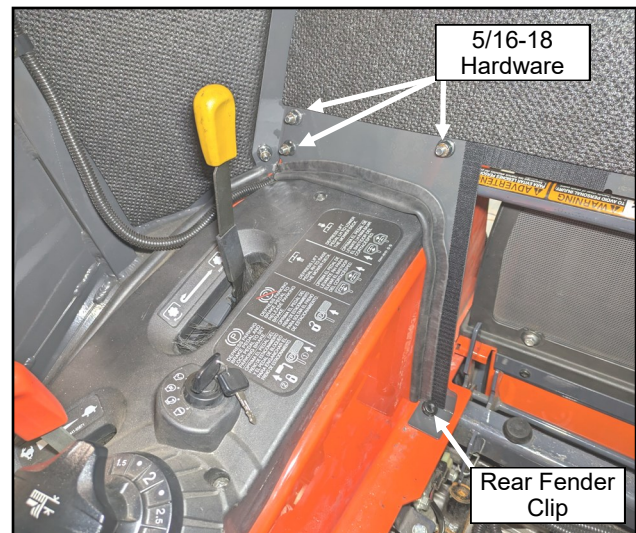

Fig. 10.2 (Install Right Fender Filler)

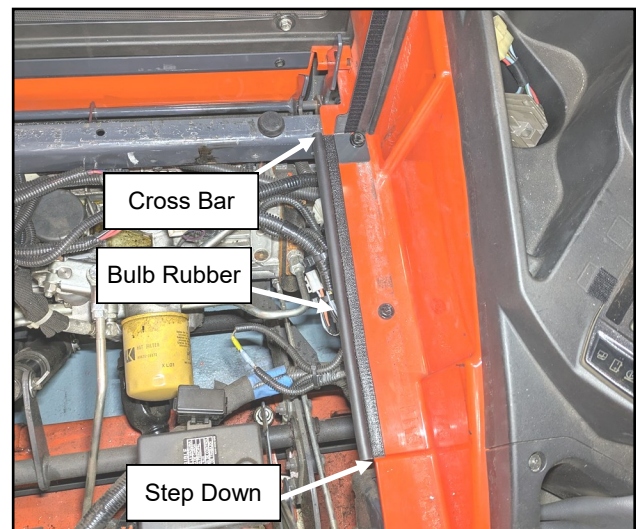

Fig. 10.3 (Install Bulb Rubber)

CAB INSTALLATION

10.4 See fig. 10.4. Apply the under seat insulating panel to the bottom of the seat tray.

10.5 See fig. 10.5. Remove and save the two rear (top) nuts that secure the seat to the tray. Loosen the front (bottom) nuts enough to allow the seat to tilt away from the tray. Remove and discard the two thick washers that are installed between the seat track and seat tray.

10.6 See fig. 10.6. Slide the seat tray panel onto the seat track studs. Tip the seat back toward the seat tray, ensuring the bulb rubber on the sides stays in place at the front (bottom) and does not get bound up on the sides of the seat tray. Reinstall the two rear (top) nuts and tighten all four nuts.

10.7 Lower the seat and secure both rubber side flaps to the rear panel and side filler panels.

Step 11: (Final Installation)

11.1 See fig. 11.1. Re-install doors and install gas shocks. The end with the red tab should be attached to the side frame of the vehicle.

11.2 Re-install the front hinged cover if working on a 60" mower.

11.3 If working on a 72" mower, inspect along the floormat across the entire front of the vehicle and apply a bead of black silicone to fill any gaps that may occur.

11.4 Re-install battery cover.



Fig. 10.4 (Under Seat Insulating Panel)



Fig. 10.5 (Loosen Seat From Seat Tray)

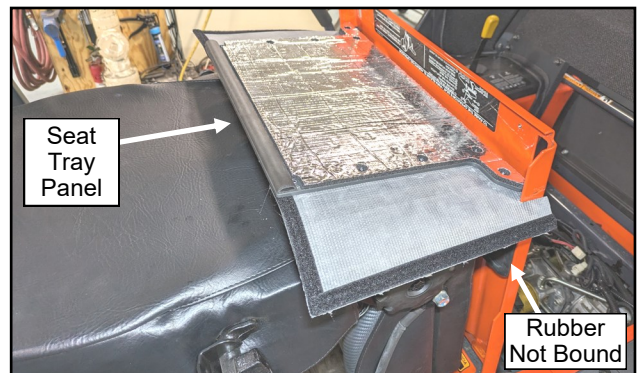

Fig. 10.6 (Install Seat Tray Panel)

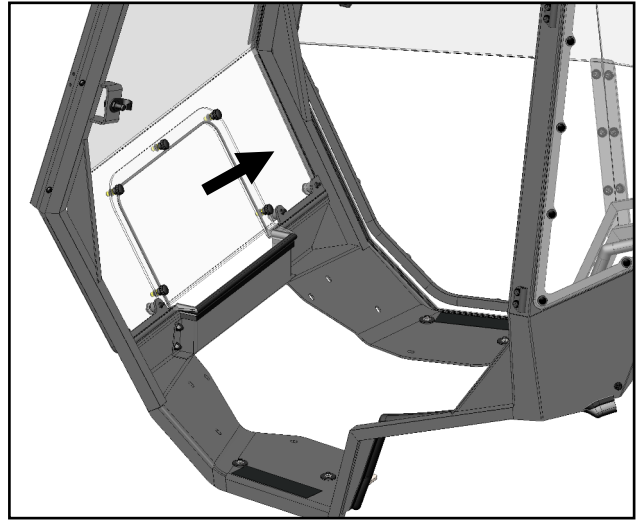

Fig. 11.1 (Attach Gas Shock)

CAB FEATURES & OPERATION

REMOVABLE FRONT WINDOW

When pivoting the front axle, remove the (5) thumb nuts securing the front center window. This will allow the front cover to fully open to clear the axle.



Removable Front Window

AIR CONDITIONING OPERATION

Turn the 4 position ventilation switch to activate the blower. This can be used as just a blower with the A/C compressor turned off.

Rotate the A/C switch to the desired temperature setting to turn the compressor on/off.

In order for the A/C compressor to function, the vehicle throttle must be set at full speed.

The blower must be turned on in order for the A/C compressor to function.

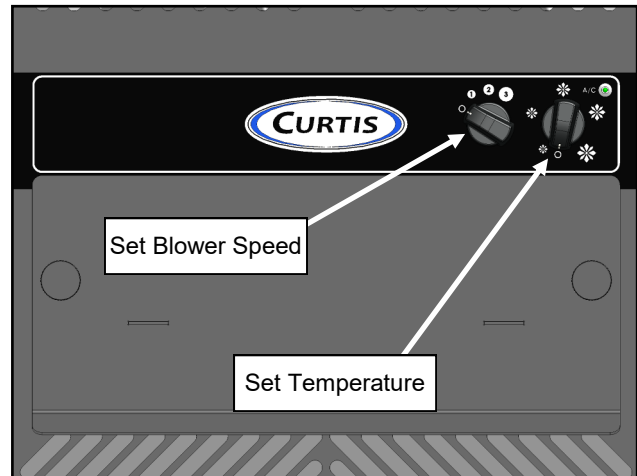

A/C Controls

AIR FILTER CHECK

Remove the two thumbscrews on the face of the A/C and slide the drawer out to access the air filter.

Change the filter as needed based on operating conditions.

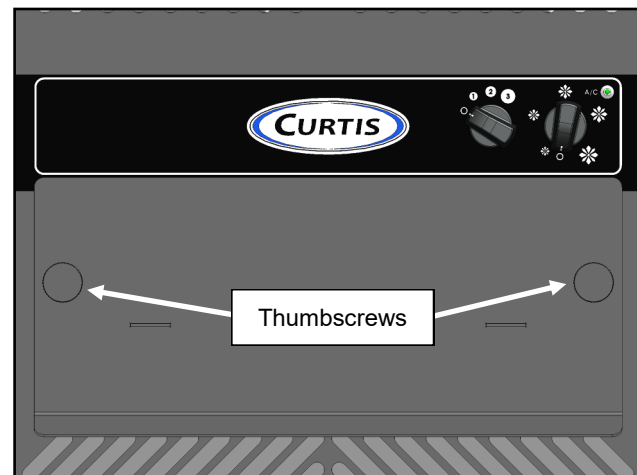

Air Filter Access

CARE AND MAINTENANCE

- DO NOT use glass cleaner to clean windows. It will damage the material. Mild dish soap and water should be used to clean all window panels. Use a soft bristled brush or sponge to clean panels.
- Avoid wiping the windows while they are dry. Hose down with water to remove heavy debris before wiping windows. Water acts as a lubricant to help prevent scratches.
- Re-apply grease periodically as needed to the door striker pins, door latch assemblies, and the door hinges.
- Check the belt tension after the first 10 hours of use. Re-check tension every 50 hours thereafter, or annually, whichever comes first.**
- Check and tighten hardware after 40 hours of operation. Periodically inspect and tighten hardware for the remainder of the unit's life. Check for any wearing or chaffing on hoses or wiring and correct as necessary.
- Wash the painted surfaces of the cab with commercial automotive cleaning products.
- Change cabin air filter as required depending on usage conditions.
- Inspect / clean the exterior of the condenser of all dust and debris daily.
- This product is designed with the use of R134a as a refrigerant. Never substitute other refrigerants, use of any other refrigerant will void warranty.
- Charge unit with 2.3 lbs. of R134a refrigerant.
- Apply vacuum for a minimum of 30 minutes prior to charging the air conditioner with R134a.
- Do not vent refrigerant to the atmosphere. If the unit has to be discharged for any reason, recover the refrigerant in compliance with federal, state, and local laws.
- Refrigerant Oil - **use only ZEROL ESTER 68SL** to replenish any oil lost during refrigerant recovery.
- Replace the drier receiver (9SV-9AC-00003) when replacing a compressor (9SV-9AC-00006).

TROUBLESHOOTING

- Ensure that throttle lever is activating the switch when moved to its max rpm position. An audible click should be heard when moving the throttle with the vehicle off.
- Check all electrical connections to ensure that proper connections are made and terminals are all tight.
- Check Battery Condition:
Resting/No Load Voltage should be 12.35V or greater.
Terminals should be clean and tight.
- Check all fuses:
30 amp fuse located at battery
15 amp fuse located near relays, located inside the air conditioner. (accessible with filter drawer removed)
20 amp fuse located near regulator under operator's seat
- Check both relays. Located inside the air conditioner. (accessible with filter drawer removed)
- Check regulator output. The output should be 12-14 volts DC.
- Check the tension of the OEM and secondary drive belts

BELT ADJUSTMENT SEQUENCE

Follow this sequence to adjust or replace the OEM V-belt driving the water pump and dynamo. ***It is critical that the following steps are completed in order and followed closely. Failure to do so may result in vehicle overheating or other vehicle/component damage.***

Note: The A/C V-belt must be re-tensioned if the OEM V-belt requires any adjustment.

1. Remove the shroud covering the A/C compressor.
2. Loosen (1/2 turn) the A/C compressor pivot bolts/nut (A), then the tensioner bolt (B). Remove A/C V-belt.
3. Loosen (1/2 turn) the dynamo pivot bolt/nut (C), then the tensioner bolt (D). Optional: Replace OEM V-belt.
4. Rotate the dynamo to tension the OEM V-belt and tighten the tensioner bolt (D).
The belt must deflect approx. **3/8"** when the center of the belt is depressed with finger pressure of **~22 lbs.**
5. Tighten the dynamo pivot bolt/nut (C).
6. Install the A/C V-belt, rotate the A/C compressor to tension the belt, and tighten the tensioner bolt (B).
The belt must deflect approx. **3/8"** when the center of the belt is depressed with finger pressure of **~22 lbs.**
7. Tighten the A/C compressor pivot bolts (A).
8. Re-install the shroud over the A/C compressor.

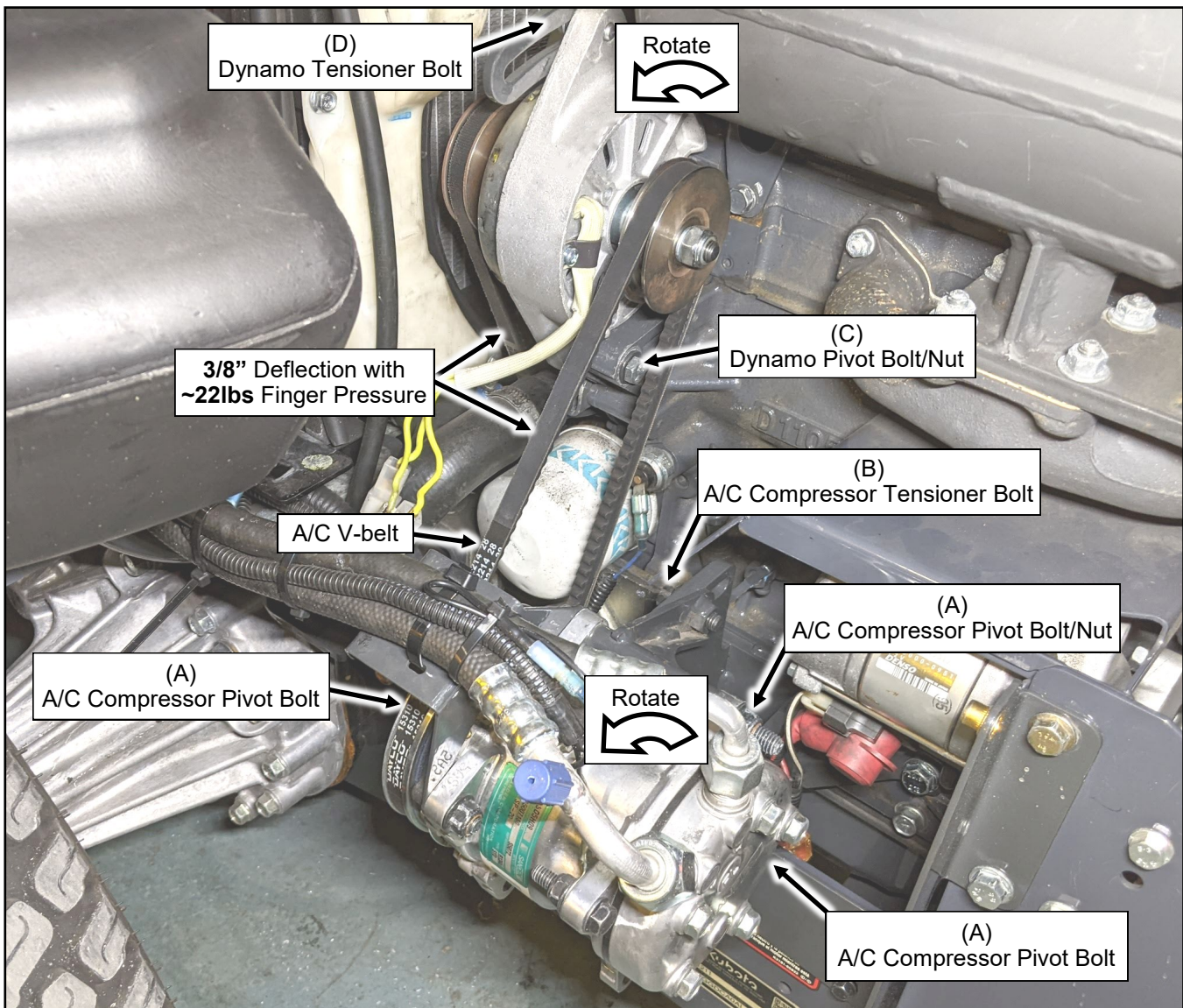

(Belt Adjustment Sequence)

SERVICE PARTS

ROOF ASSEMBLY
P/N: 8SV-101-00056

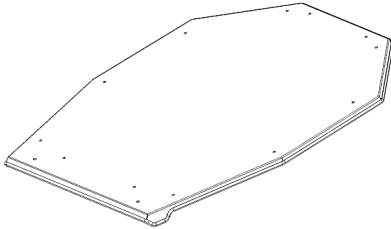

WINDSHIELD ASSEMBLY
P/N: 8SV-102-00030

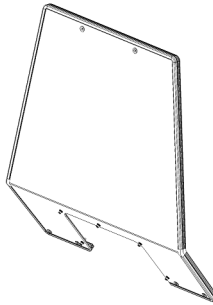

WINDSHIELD SUPPORT ASSEMBLY
P/N: 8SV-103-00024

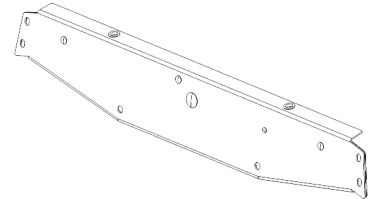

REAR PANEL ASSEMBLY
P/N: 8SV-106-00055

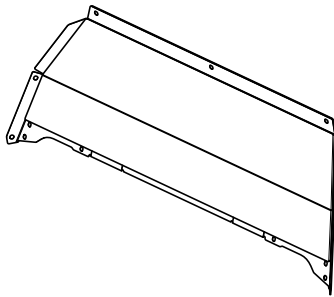

DOOR ASSEMBLY, LEFT
P/N: 8SV-107-00040-L

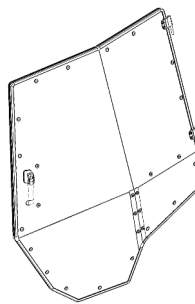

DOOR ASSEMBLY, RIGHT
P/N: 8SV-107-00040-R

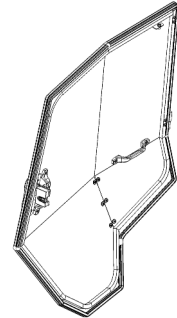

SIDEFAME ASSEMBLY, LEFT
P/N: 8SV-109-00020-L

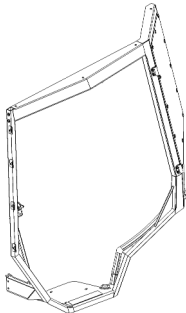

SIDEFAME ASSEMBLY, RIGHT
P/N: 8SV-109-00020-R

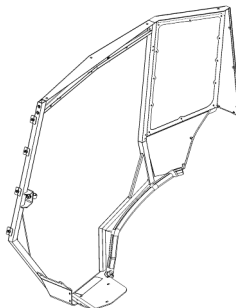

FRONT LOWER CROSS ASSEMBLY
P/N: 8SV-113-00220

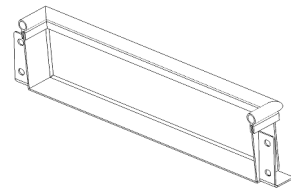

REAR FRAME ASSEMBLY
P/N: 8SV-113-00221

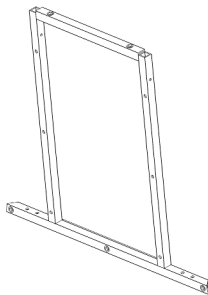

A-PILLAR CLAMP, LEFT
P/N: 8SV-SM-01727-L



A-PILLAR CLAMP, RIGHT
P/N: 8SV-SM-01727-R



SERVICE PARTS

A/C UNIT, REAR MOUNTED
P/N: 8SV-101-00005-KG

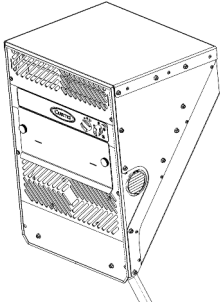

A/C COVER ASSEMBLY
P/N: 8SV-303-00013-KG

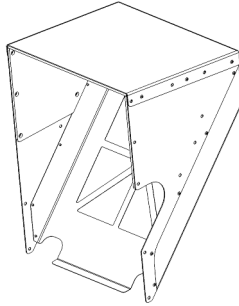

ROPS MOUNT, LEFT
P/N: 8SV-SM-01715-L

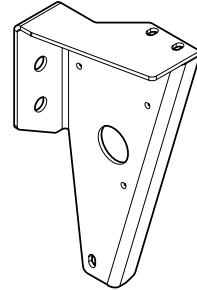

ROPS MOUNT, RIGHT
P/N: 8SV-SM-01715-R

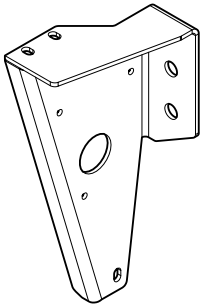

ROPS MOUNT PLATE, UPPER
P/N: 8SV-SM-02026

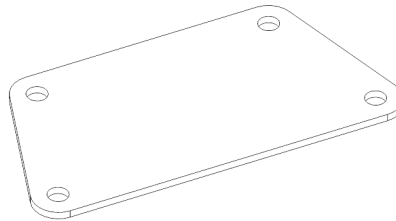

SWITCH BRACKET ASSEMBLY
P/N: 8SV-113-00227

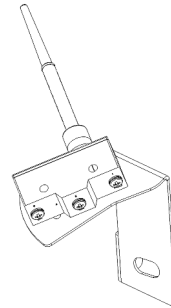

A/C AIR DIVERTER FLAP
P/N: 8SV-SM-02012

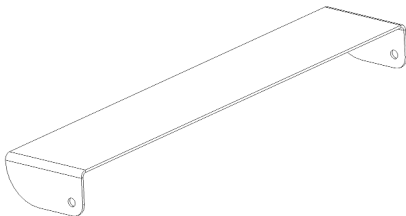

LIMIT SWITCH
P/N: 9SV-ULS-SWITCH

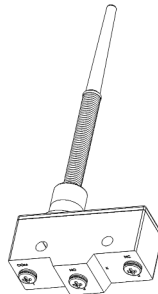

V-BELT
P/N: 9SV-9BLT-17



DYNAMO
P/N: 9SV-9ALT-06

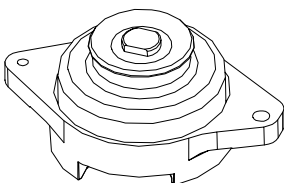

DYNAMO PULLEY, SHORT
P/N: 9SV-MP-00080

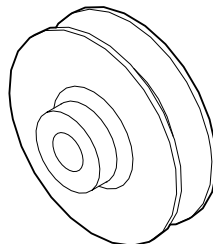

DYNAMO PULLEY, LONG
P/N: 9SV-MP-00093

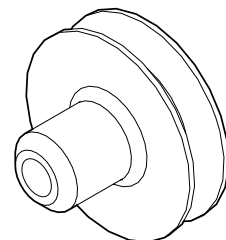

SERVICE PARTS

REGULATOR/RECTIFIER
P/N: 9SV-85-17-0065

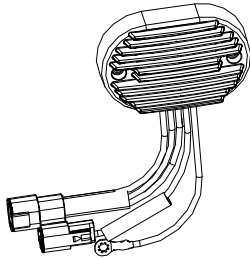

SHROUD MOUNT BRACKET
P/N: 8SV-110-00122

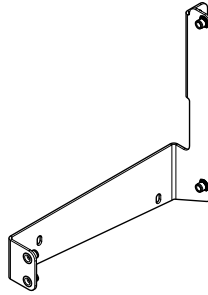

FRONT SHROUD COVER
P/N: 8SV-113-00347

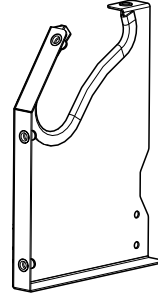

REAR SHROUD COVER
P/N: 8SV-113-00238

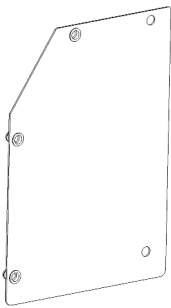

SHROUD COVER
P/N: 8SV-SM-02443

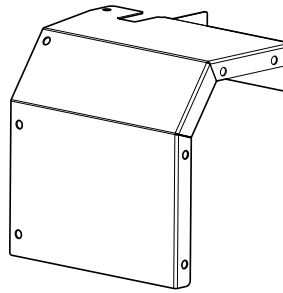

ROPS MOUNT, UPPER
P/N: 8SV-SM-01916

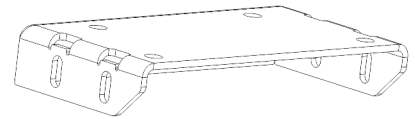

ROPS BRACKET, ROOF TAB
P/N: 8SV-SM-01917

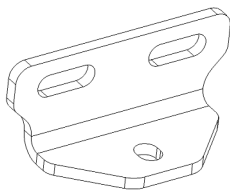

COMPRESSOR ADJUSTMENT ARM
P/N: 8SV-WA-00421

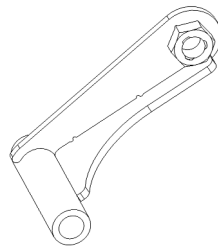

COMPRESSOR BRACKET
P/N: 8SV-WA-00578

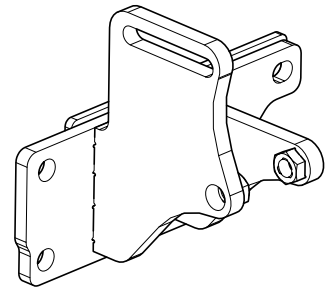

FRONT BRUSH PANEL
P/N: 8SV-111-00033

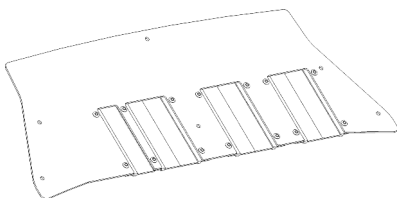

HOSE, #8, COMP TO COND
P/N: 8SV-305-00022

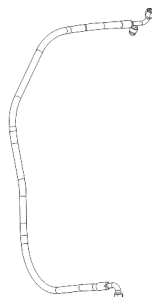

HOSE, #6, DRIER TO EVAP
P/N: 8SV-305-00023

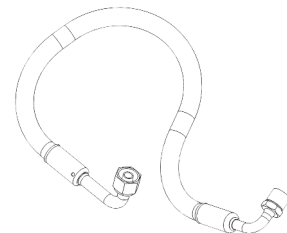

SERVICE PARTS

HOSE, #10 EVAP TO COMP
P/N: 8SV-305-00024

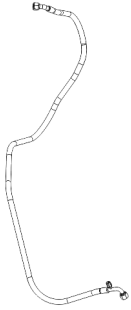

HOSE, #6, COND TO DRYER
P/N: 8SV-305-00025

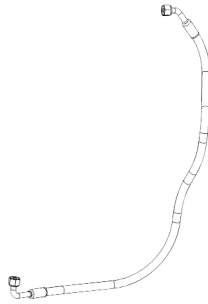

FRONT REMOVABLE PANEL
P/N: 9SV-P-00132

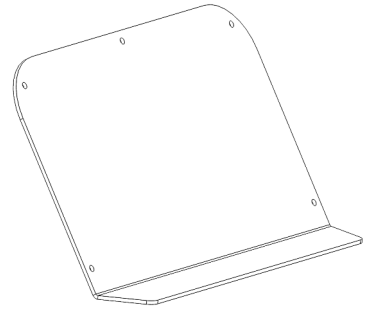

DOOR SKIN, LEFT, W/ HARDWARE
P/N: 9SV-P-00133-L

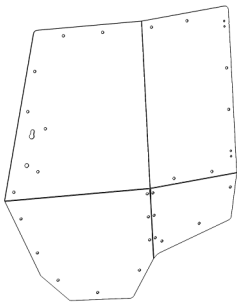

DOOR SKIN, RIGHT, W/ HARDWARE
P/N: 9SV-P-00133-R

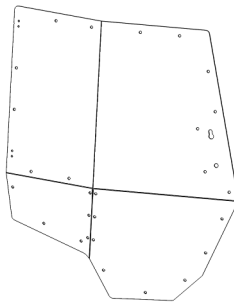

REAR LEG WINDOW, W/ HARDWARE
P/N: 9SV-P-00128

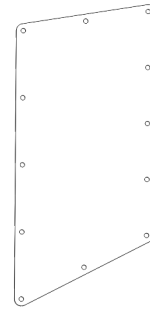

THUMB NUTS (QTY: 5)
P/N: 9SV-72-89-0094

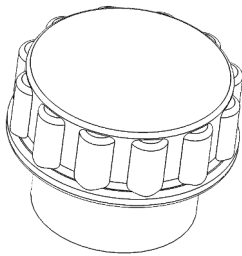

LOUVERED PLUG WITH FILTER
P/N: 9SV-9DP25



EVAPORATOR
P/N: 8SV-9AC-00046

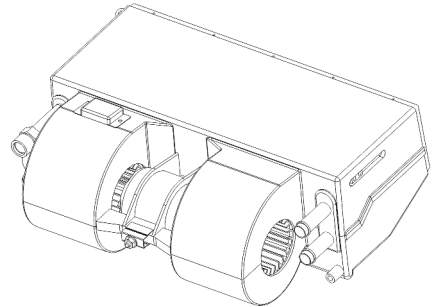

KNOB
P/N: 9SV-OHC-27

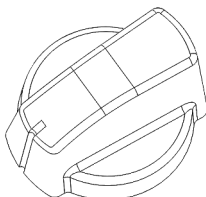

A/C WIRE HARNESS
P/N: 9SV-WH-00130



AIR FILTER
P/N: 9SV-9HR-00032

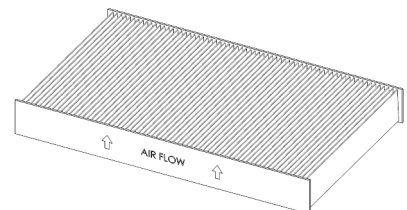

SERVICE PARTS

A/C COMPRESSOR
P/N: 8SV-9AC-00048-A

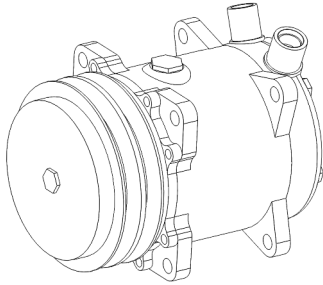

LEFT SIDE DRIVE HANDLE FILLER
P/N: 8SV-112-00071-L

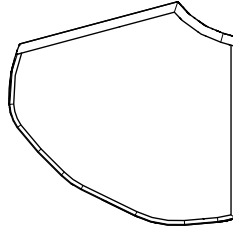

RIGHT SIDE DRIVE HANDLE FILLER
P/N: 8SV-112-00071-R

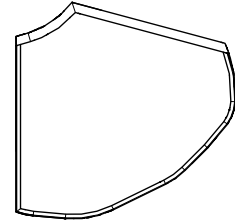

FLEX BRUSH PANEL (W-BRUSHES)
P/N: 8SV-111-00038

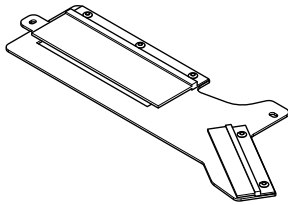

LEFT FENDER FILLER PANEL
P/N: 8SV-111-00055-L

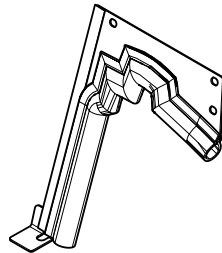

RIGHT FENDER FILLER PANEL
P/N: 8SV-111-00055-R

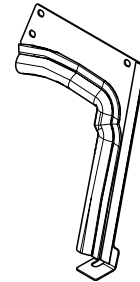

SEAT TRAY PANEL
P/N: 8SV-113-00401

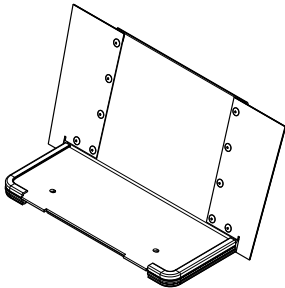

ADDITIONAL SERVICE PARTS

PART NUMBER	DESCRIPTION
9SV-HWK-00205	HARDWARE KIT, CAB FASTENERS
9SV-OHRL-G	OUTSIDE DOOR HANDLE (SET OF 2)
9SV-GH	INTERIOR GRAB HANDLE (SET OF 2)
9SV-HSLP	HINGE PINS AND SLEEVES (2L + 2R)
9SV-DP10	DOME PLUG, .375" HOLE (BAG OF 10)
9SV-DP16	DOME PLUG, .750" HOLE (BAG OF 4)
9SV-DP04	DOME PLUG, 1.125" HOLE (BAG OF 15)
9SV-9OR-01	O-RINGS, (INCL 1 OF EA: .301" ID .426" ID .551" ID)
9SV-GS02A	BALL STUD 10MM (BAG OF 10)
9SV-DL06S	INTERIOR DOOR LATCH W/COVER (1L +1R)
9SV-9AC-00001	CONDENSER
9SV-85-01-0022	RELAY, 12V, 20/40A, SPDT, MINI ISO
9SV-9AC-00003	DRIER RECEIVER
9SV-9AC-00005	PRESSURE SWITCH, 2-28KG/CM2
9SV-9AC-00007	AXIAL FAN FOR CONDENSER
9SV-DSTRH	DOOR STRIKER PIN (BAG OF 5)
9SV-GS02Q	GAS SHOCK 12-3/8" (SET OF 2)
9SV-9AC-00046-BS	BLOWER SWITCH
9SV-9AC-00046-TS	THERMOSTAT SWITCH
9SV-WH-00155	WIRE HARNESS, AC DYNAMO, THREE PHASE

TRIM LOK, STD,
1/16" - 1/8" GRIP



9SV-PRO1-20

5/8" STD BULB,
1/16" GRIP



9SV-PRO2-15

3/4" SIDE BULB,
1/16" GRIP

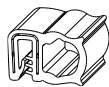

9SV-PR17-20

3/4" SIDE BULB,
1/4" GRIP



9SV-PR38-15

ARCH PSA,
.20" X.15"

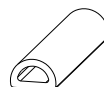

9SV-PR53-15

1" ROUND BULB,
1/16" GRIP



9SV-PR19-10

1/2"
WEATHERSEAL



9SV-PR20-10

FOAM TAPE,
1/8" X 2"



9SV-PR35-5

FOAM TAPE,
1/8" X 1"



9SV-PR39-5



BOLT TORQUE

BOLT TORQUE SPECIFICATIONS

GENERAL TORQUE SPECIFICATION TABLE

Use the following torques when special torques are not given. These values apply to fasteners as received from suppliers, dry, or when lubricated with normal engine oil. They do not apply if special graphited or moly disulphide greases or other extreme pressure lubricants are used. This applies to both UNF and UNC threads. Remember to always use grade five or better when replacing bolts.

IMPORTANT: On all PLATED GRADE 8 bolts, reduce torque 15% from listed bolt torque specification.

SAE Grade No.		2				5				8*			
Bolt head identification mark as per grade. NOTE: Manufacturing Marks Will Vary													
		TORQUE		TORQUE		TORQUE		TORQUE		TORQUE		TORQUE	
Bolt Size		Pounds Feet		Newton-Meters		Pounds Feet		Newton-Meters		Pounds Feet		Newton-Meters	
Inches	Millimeters	Min.	Max.	Min.	Max.	Min.	Max.	Min.	Max.	Min.	Max.	Min.	Max.
1/4	6.35	5	6	7	8	9	11	12	15	12	15	16	20
5/16	7.94	10	12	14	16	17	20.5	23	28	24	29	33	39
3/8	9.53	20	23	27	31	35	42	48	57	45	54	61	73
7/16	11.11	30	35	41	47	54	64	73	87	70	84	95	114
1/2	12.70	45	52	61	70	80	96	109	130	110	132	149	179
9/16	14.29	65	75	88	102	110	132	149	179	160	192	217	260
5/8	15.88	95	105	129	142	150	180	203	244	220	264	298	358
3/4	19.05	150	185	203	251	270	324	366	439	380	456	515	618
7/8	22.23	160	200	217	271	400	480	542	651	600	720	814	976
1	25.40	250	300	339	406	580	696	787	944	900	1080	1220	1464
1-1/8	25.58	-	-	-	-	800	880	1085	1193	1280	1440	1736	1953
1-1/4	31.75	-	-	-	-	1120	1240	1519	1681	1820	2000	2468	2712
1-3/8	34.93	-	-	-	-	1460	1680	1980	2278	2380	2720	3227	3688
1-1/2	38.10	-	-	-	-	1940	2200	2631	2983	3160	3560	4285	4827

*Thick Nuts must be used with Grade 8 bolts

METRIC BOLT TORQUE SPECIFICATIONS

Size of Screw	Property Class	Course Thread			Fine Thread		
		Pitch (mm)	Pounds Feet	Newton-Meters	Pitch (mm)	Pounds Feet	Newton-Meters
M6	5.6	1.0	3.6-5.8	4.9-7.9	-	-	-
	8.8		5.8-9.4	7.9-12.7		-	-
	10.9		7.2-10	9.8-13.6		-	-
M8	5.6	1.25	7.2-14	9.8-19	1.0	12-17	16.3-23
	8.8		17-22	23-29.8		19-27	25.7-36.6
	10.9		20-26	27.1-35.2		22-31	29.8-42
M10	5.6	1.5	20-25	27.1-33.9	1.25	20-29	27.1-39.3
	8.8		34-40	46.1-54.2		35-47	47.4-63.7
	10.9		38-46	51.5-62.3		40-52	54.2-70.5
M12	5.6	1.75	28-34	37.9-46.1	1.25	31-41	42-55.6
	8.8		51-59	69.1-79.9		55-68	75.9-92.1
	10.9		57-66	77.2-89.4		62-75	84-101.6
M14	5.6	2.0	49-56	66.4-75.9	1.5	52-64	70.5-86.7
	8.8		81-93	109.8-126		90-106	122-143.6
	10.9		96-109	130.1-147.7		107-124	145-168
M16	5.6	2.0	67-77	90.8-104.3	1.5	69-83	93.6-112.5
	8.8		116-130	157.2-176.2		120-138	162.6-187
	10.9		129-145	174.8-196.5		140-158	189.7-214.1
M18	5.6	2.0	88-100	119.2-136	1.5	100-117	136-158.5
	8.8		150-168	203.3-227.6		177-199	239.8-269.6
	10.9		175-194	237.1-262.9		202-231	273.7-313
M20	5.6	2.5	108-130	146.3-176.2	1.5	132-150	178.9-203.3
	8.8		186-205	252-277.8		206-242	279.1-327.9
	10.9		213-249	288.6-337.4		246-289	333.3-391.6